

Precious Design

Abacus

Moiré

Oscar

TERZANI
LA LUCE PENSATA

Pug

Gaia





Precious Design



Index

008 Abacus
046 Gaia
032 Moiré
020 Oscar
040 Pug

Terzani's Precious Design Concept is luxury evolved. Each piece in this new lighting collection breaks the staid boundaries of traditional luxury, and incorporates stunningly modern design, cutting-edge technology, artisan craftsmanship and precious materials.

The result are sculptures of light whose illumination transforms spaces through dynamic lighting and shadow effects. They create a new visual language of what luxury is, one that reflects both today's aesthetics, architecture and design traditions yet also pushes towards the future.



Abacus, multiplying *luminescence.*

Used for centuries as the tool to both teach and communicate mathematics, the abacus was found in one form or another across the ancient world. At Terzani, we saw the beauty in the abacus' mathematical purity and clean, functional design. In the hands of Terzani's craftsmen, we've turned this inspiration into a new collection of modular pendant lamps whose flexibility allows for complex and beautiful configurations. Each module, or strand, of Abacus contains a custom set of round, hand-blown opal glass which emit a soft and uniform light. And, as the original abacus was used to calculate everything from simple addition to complex formulas, we've retained the same scalability. Due to its customization, our Abacus light is just as suitable in a home as a commercial space, and its almost infinite configurations makes sure you always come up with the right solution.





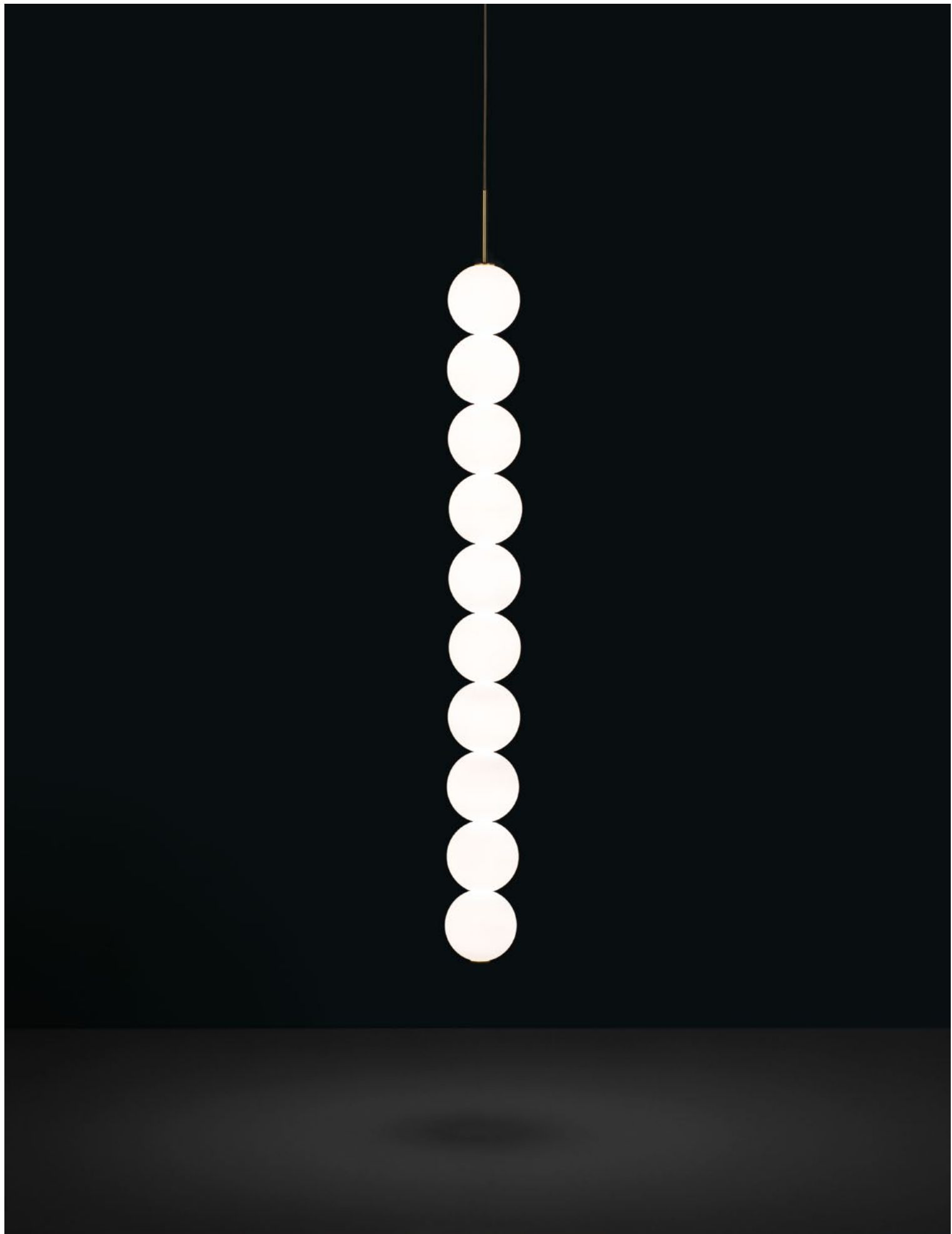

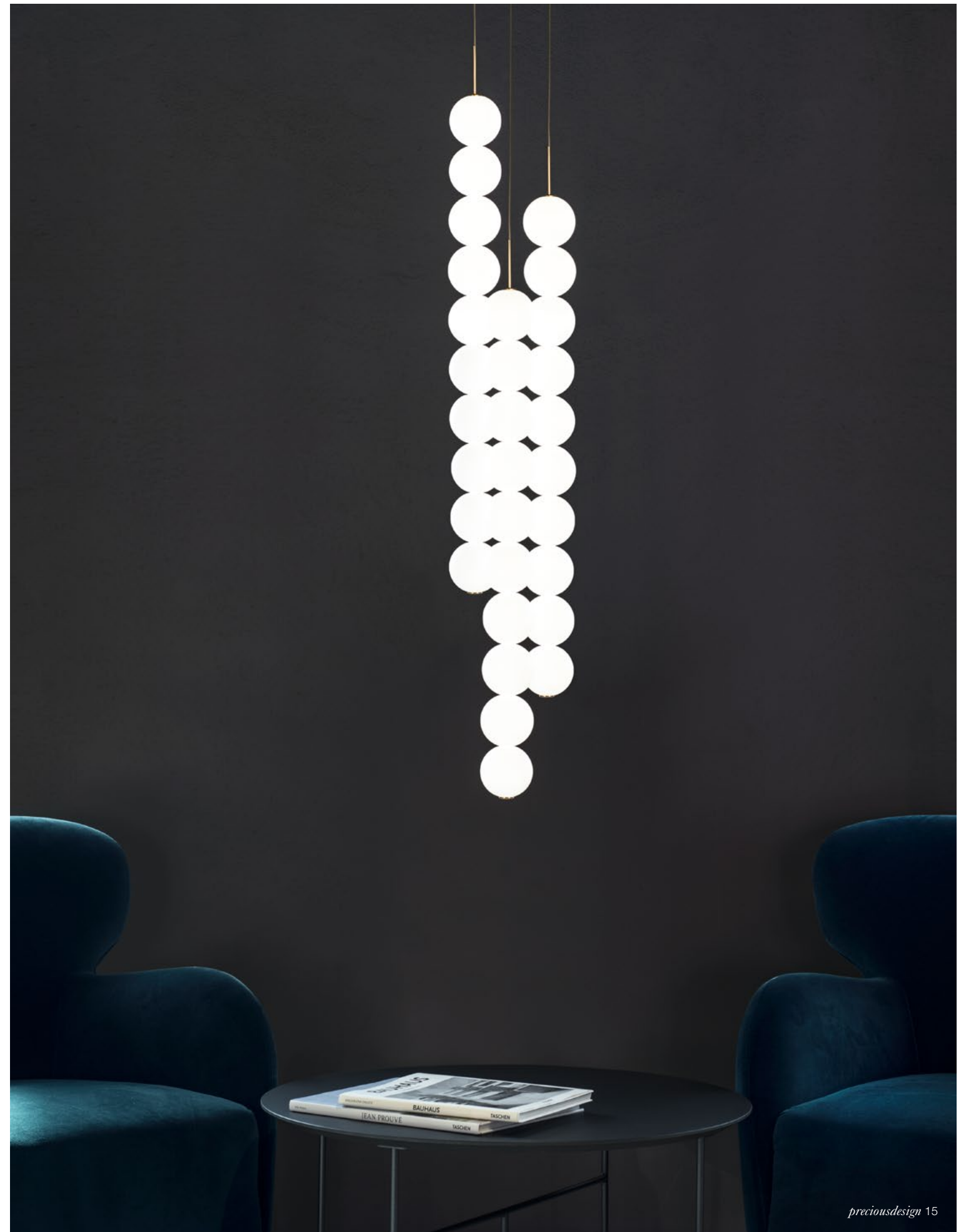
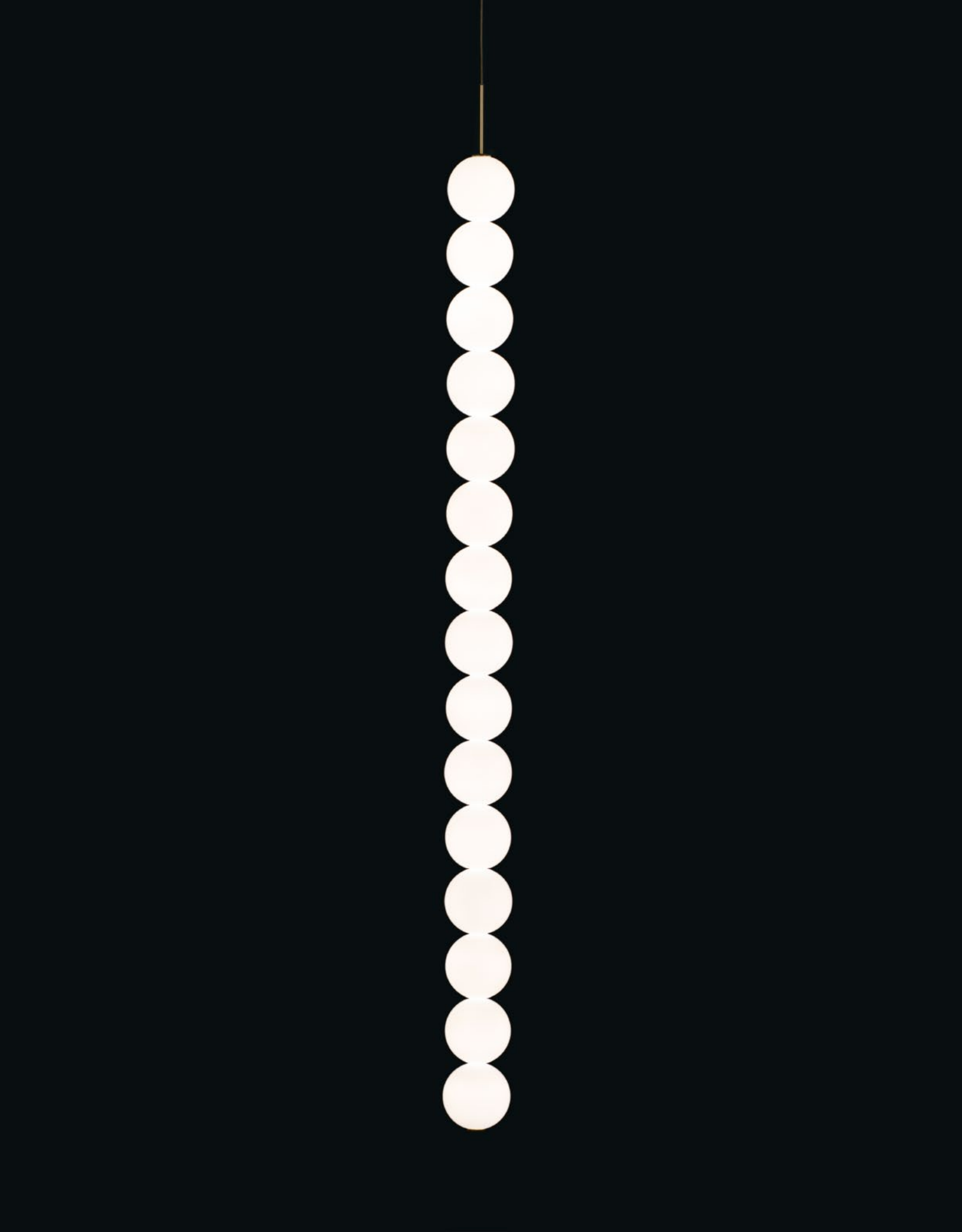

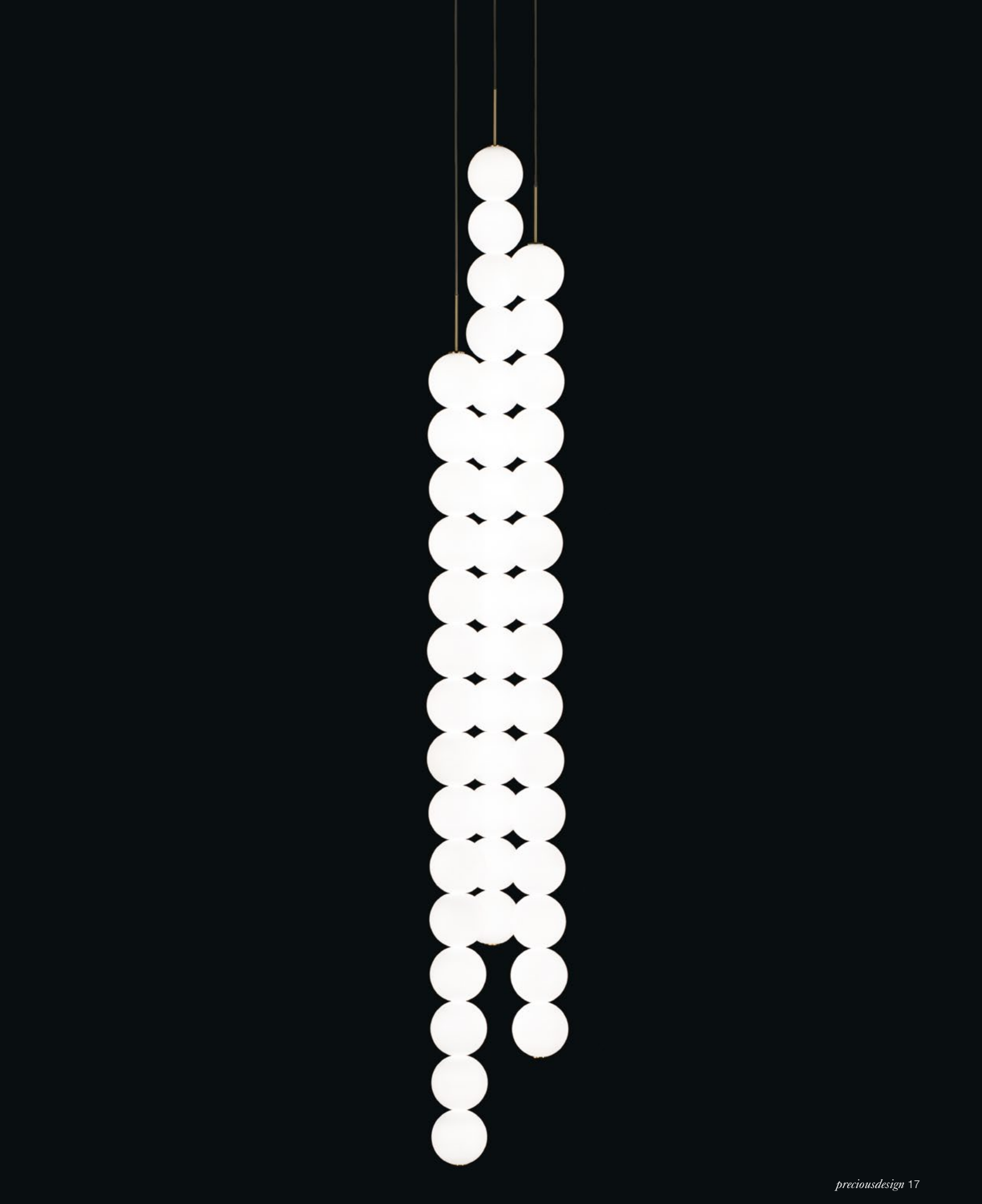

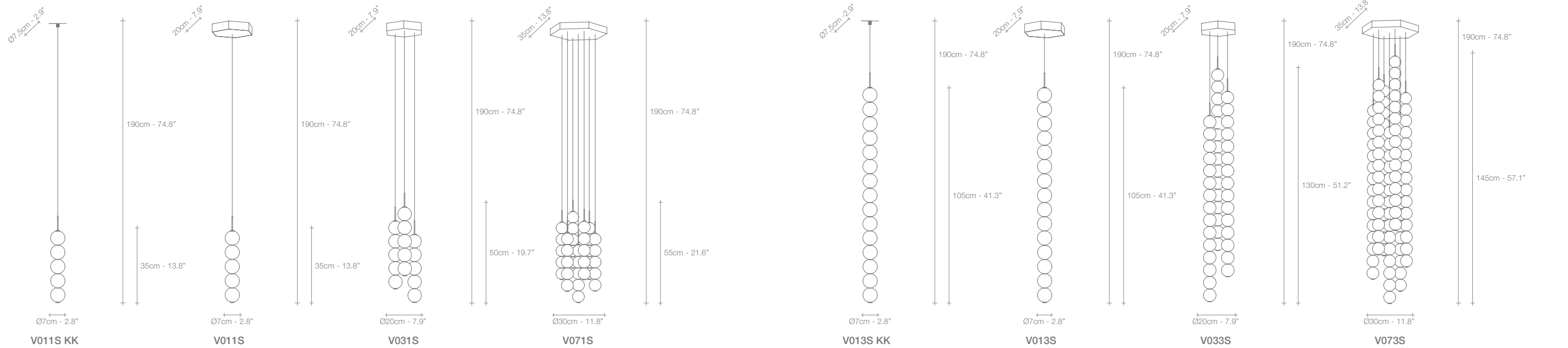

V011S KK
N/A in North America

V011S

V031S

V071S

V013S KK
N/A in North America

V013S

V033S

V073S

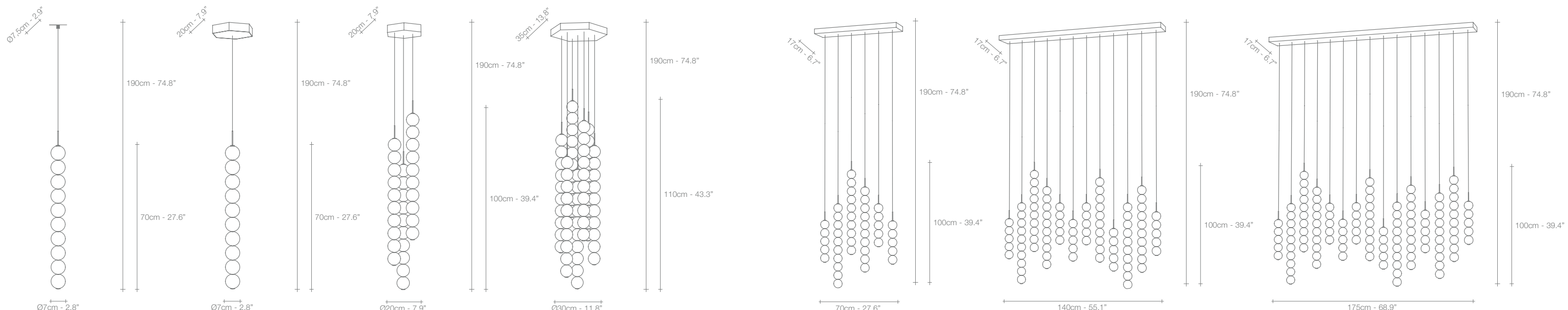

V012S KK
N/A in North America

V012S

V032S

V072S

V06S

V12S

V15S



BRASS
SATIN WHITE
GLASS

	INTEGRATED LED	V011S	V012S	V013S	V031S	V032S	V033S	V071S	V072S	V073S	V06S	V12S	V15S
230V	LED BOARD 3000K	3,6W 540lm	7,2W 1080lm	10,8W 1620lm	3 x 3,6W 3240lm	3 x 7,2W 4860lm	3 x 10,8W 4860lm	7 x 3,6W 3780lm	7 x 7,2W 7560lm	7 x 10,8W 11340lm	3 x 3,6W 3 x 7,2W 4860lm	6 x 3,6W 6 x 7,2W 9720lm	7 x 3,6W 8 x 7,2W 12420lm
	Dimmer	0-10V PWM	0-10V PWM	0-10V PWM	0-10V PWM	0-10V PWM	0-10V PWM	0-10V PWM	0-10V PWM	0-10V PWM	0-10V PWM	0-10V PWM	0-10V PWM
120V	LED BOARD 3000K	3,6W 540lm	7,2W 1080lm	10,8W 1620lm	3 x 3,6W 1620lm	3 x 7,2W 3240lm	3 x 10,8W 4860lm	7 x 3,6W 3780lm	7 x 7,2W 7560lm	7 x 10,8W 11340lm	3 x 3,6W 3 x 7,2W 4860lm	6 x 3,6W 6 x 7,2W 9720lm	7 x 3,6W 8 x 7,2W 12420lm
	Dimmer	0-10V PWM	0-10V PWM	0-10V PWM	0-10V PWM	0-10V PWM	0-10V PWM	0-10V PWM	0-10V PWM	0-10V PWM	0-10V PWM	0-10V PWM	0-10V PWM

Different dimming options on request

Oscar, *a tribute.*

The great Brazilian architect Oscar Niemeyer once said about his work: "It's not the right angle that attracts me, nor the straight line. Stiff, inflexible, created by men. What really attracts me is the free, sensual curve. The curve I see on the sinuous course of our rivers, on the clouds in the sky, on your favorite woman's body. The universe is entirely made of curves". Inspired to pay tribute to one of the founders of modern architecture, designer Dodo Arslan has created a series of lights named "Oscar", which pay homage through their adoption of Niemeyer's signature sensuous curves. Oscar table lamp consists of a glass orb delicately held by curved brass.





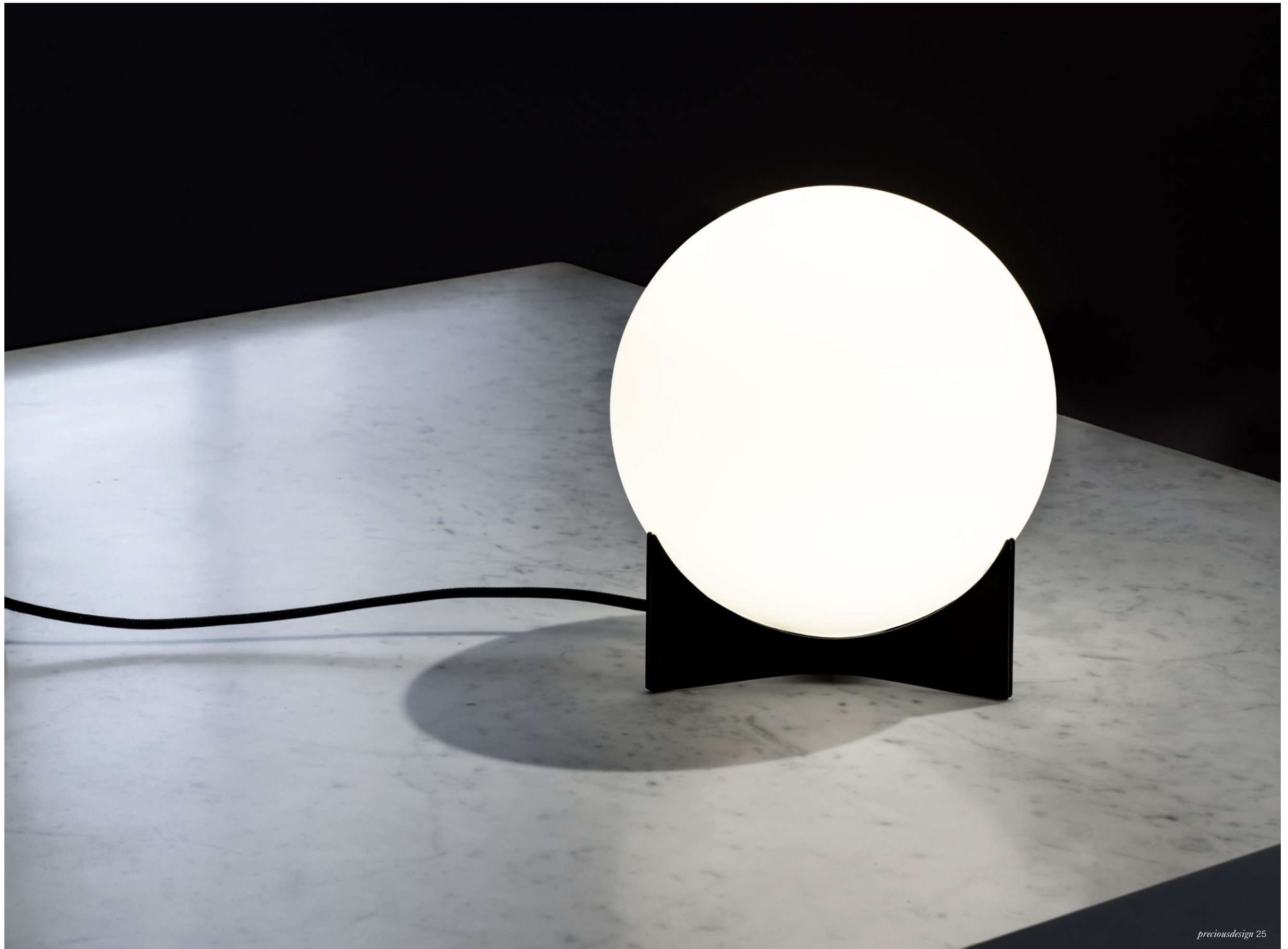





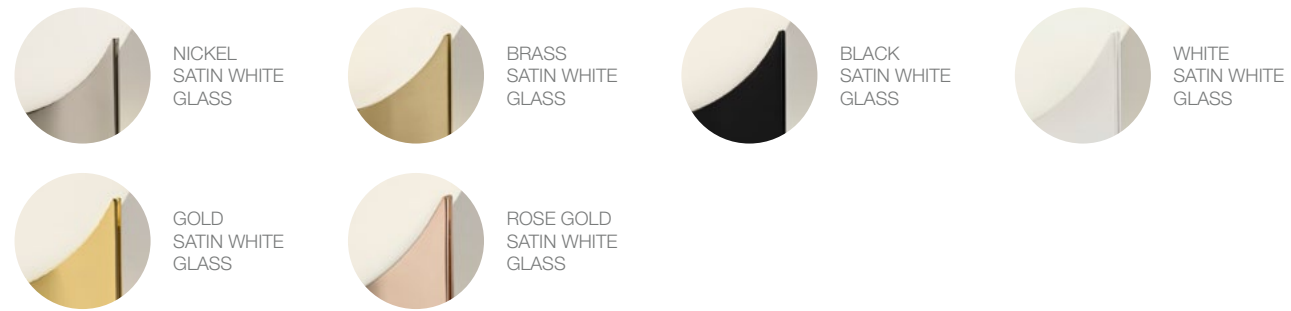
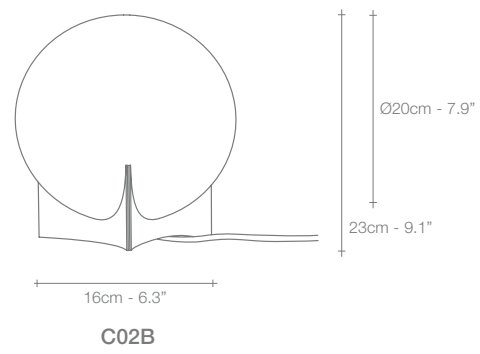

RECOMMENDED BULB		C02B
230V	E14 LED	7W
	Dimmer integrated	
120V	E12 LED	7W
	Dimmer integrated	



Moiré, movement *with pattern.*

A French term derived from silk with a rippled or “watered” appearance, moiré is an optical effect that results in the illusion of waves or the movement of water. This effect is achieved by having an opaque, ruled pattern overlaid over another. Designer Christian Lava’s studies of this effect have led to his latest design aptly titled, Moiré. Using overlapping grids of metal, this LED pendant light dynamically changes shape following the viewer’s gaze, practically coming to life with a vibrating energy. Available in multiple configurations, Moiré is a mesmerizing addition to any room.







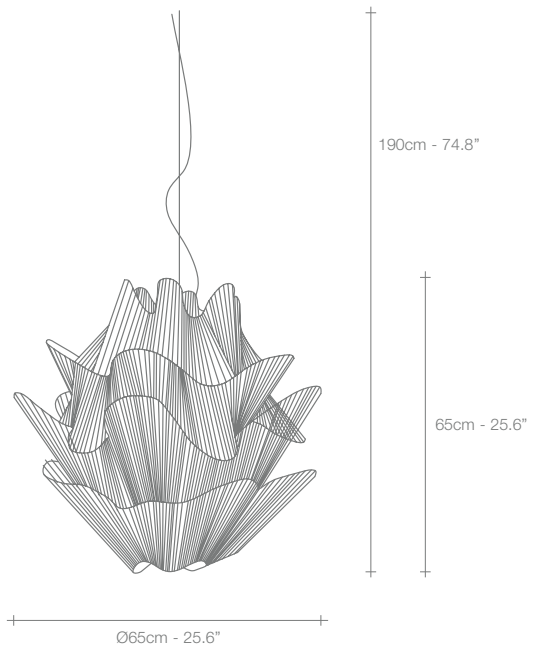



M10S



NICKEL



GOLD

	INTEGRATED LED	M10S
230V	 LED 3000K Dimmer	15,2W 1952lm 1-10V PUSH
120V	 LED 3000K Dimmer	15,2W 1952lm 1-10V PUSH

Different dimming options on request, 2700K LED boards on request



Pug, multum *in parvo.*

Pug is a dog described as “much in little”, referring to the greatness of his personalities despite his diminutive size. Inspired by the Pug’s charm, designer Jean-François Crochet created the Pug pendant light whose protruding spherical lights are reminiscent of a pug’s face. As with the breed, the Pug pendant packs significant charm and beauty into a small package. Illuminated by LED light, these glass pendants are framed by two brass bands. With Pug, it’s easy to bring a new best friend (or pack of friends) into a home.





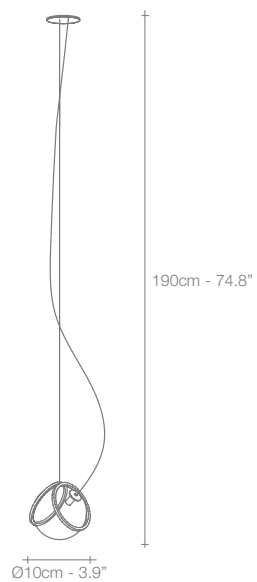

U01S KK

N/A in North America

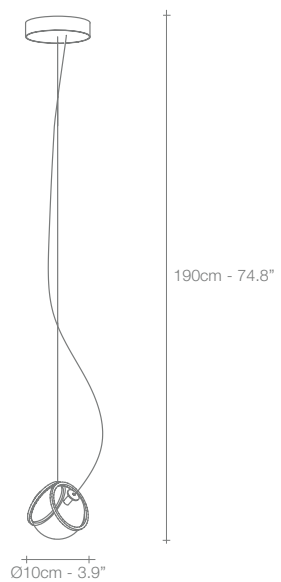

U01S

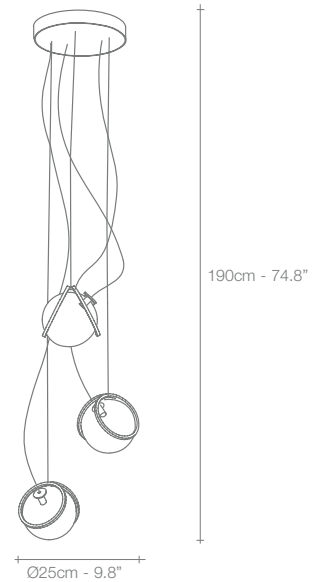

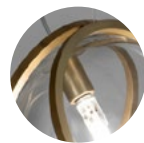

U03S



RAW BRASS
CLEAR GLASS



POLISHED BRASS
SATIN WHITE
GLASS

RECOMMENDED BULB		U01S	U03S
230V		G4 LED 3000K	1,5W 3x1,5W
		Dimmer	no IGBT
120V		G4 LED 3000K	1,5W 3x1,5W
		Dimmer	no IGBT TRIAC

Different dimming options on request



Gaia, earth *mother.*

In Greek mythology, Gaia is the personification of the Earth and the mother of all life. Looking to capture the mythical and natural beauty of this Earth goddess, designer Jean- François Crochet has created the Gaia pendant light. Consisting of geometric frames of brass or steel reminiscent of the mountains Gaia created, the pendant uses led light to push light through the “cracks” formed. The resulting light creates a magical feeling, as if the lights peaking through were alive themselves. Available to custom configurations, Gaia adds a vibrancy and sacred light to any space.



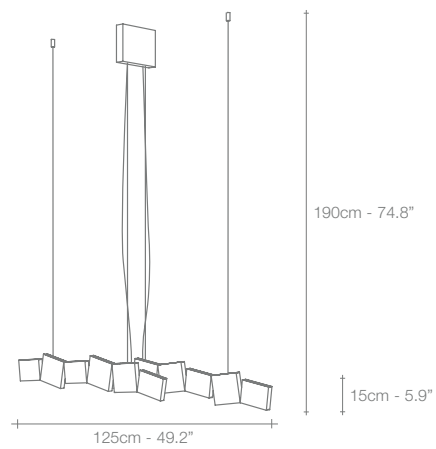

G40S

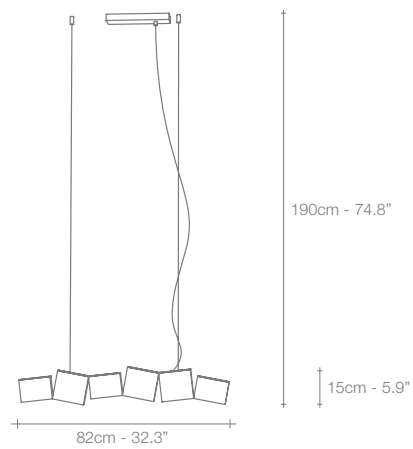



G41S

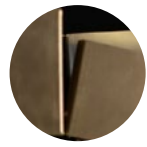

RAW METAL



BRASS

	INTEGRATED LED	G40S	G41S
230V	 <p>LED 3000K</p>	<p>24x1,5W 4320lm</p>	<p>12x1,5W 2160lm</p>
	<p>Dimmer </p>	<p>0/1-10V PUSH DALI</p>	<p>1-10V PUSH</p>
120V	 <p>LED 3000K</p>	<p>24x1,5W 4320lm</p>	<p>12x1,5W 2160lm</p>
	<p>Dimmer </p>	<p>0/1-10V PUSH DALI</p>	<p>0/1-10V PUSH</p>

2700K LED integrated on request



Terzani has a tradition deeply rooted in Italian craftsmanship. From shaping precious metals to painstakingly constructing every piece, our master craftsmen give attention to every design, resulting in unparalleled quality and a distinct aesthetic.





Art & Crafts



TERZANI
LA LUCE PENSATA

All products in the Terzani collections are inspired by a return to noble artisan traditions. Every object is carefully created using craft techniques and for this reason certain details may vary from product to product. These variations are not imperfections but characteristic peculiarities of the production process. Terzani reserves the right to modify its products in order to improve its features.

Product reproduction on paper may result in a misrepresentation of some colors. For updated technical data please refer to our current price list or our website. For updates on eTl , please visit our website or call our customer service. For  certification please refer to our current price list or our website. For informations about Patent & Design Registration please visit: www.terzani.com/patents

Terzani srl

Via Castelpulci Int.9
50018 Scandicci Firenze Italy
Office +39 055 722021
info@terzani.com

Terzani Usa, Inc.

2501 SW 56th Ave
Pembroke Park FL 33023
Office 954 438 7779
Toll free 1 866 380 5412
info@terzaniusa.com

Creative Direction Terzani
Art Direction Camilla Cordella
Photos Leonardo Beglieri
Digital imaging Fulvio Gallotti
Eu (Italy) 2019

terzani.com

© terzani 2019

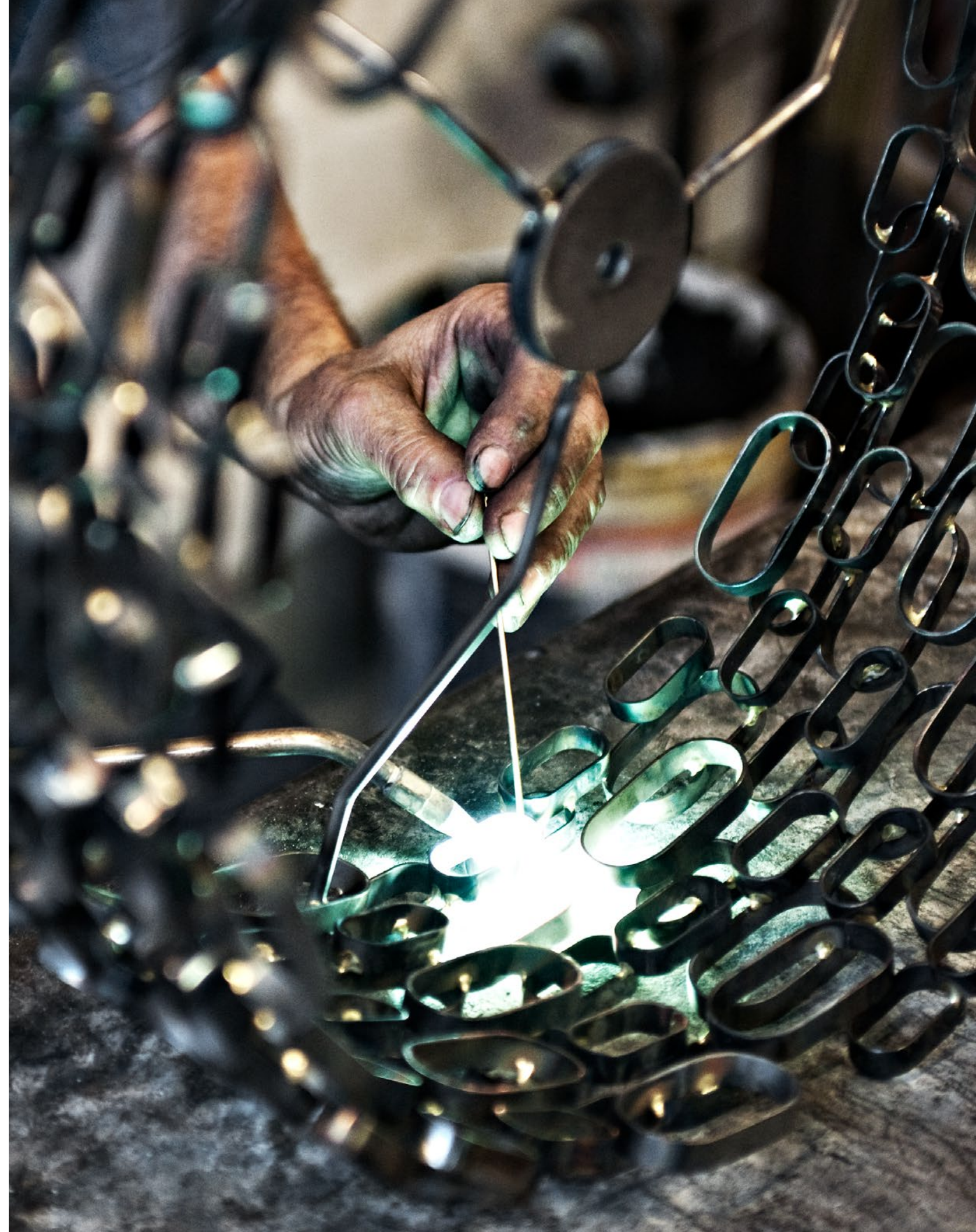



TERZANI
LA LUCE PENSATA

terzani.com