

mimax 

DECORE **.22**

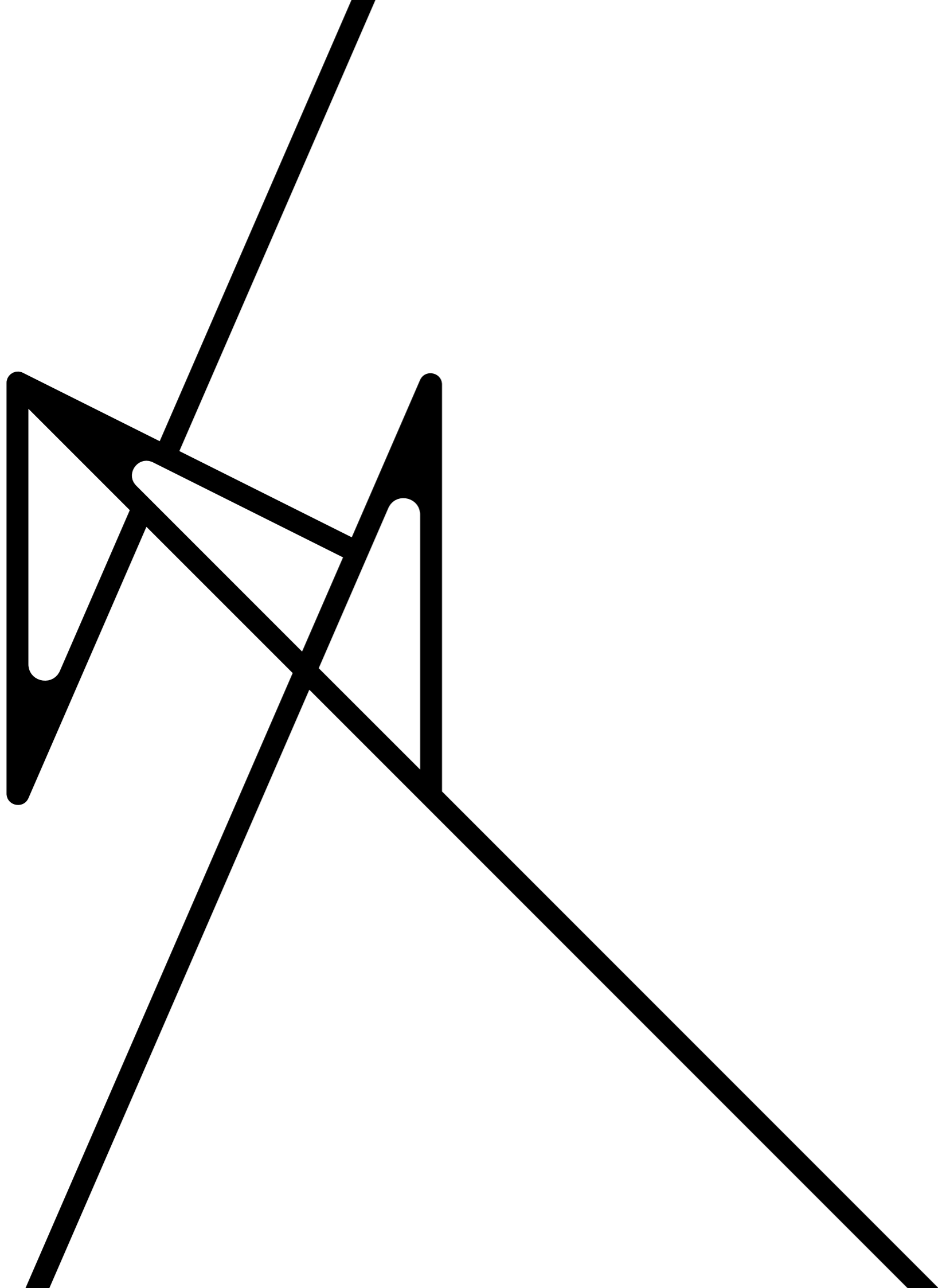

DECORE.**22**



More than
20 years
of experience
in the lighting
business led us to create
Mimax Lighting,
S.L. in 2008,
in order to answer
a need:

«
Illuminate
decorating,
and decorate
illuminating.
Form
and function.

»

We are passionate about light and we are passionate about working with it, giving soul to spaces; let it be residential spaces, commercial, hospitality, public, contract...

The customer is the base of our project. Therefore, our priority is the excellence in the service, together with the quality of our products and an honest and friendly relationship with our customers and agents.

A great selection of 1.800 items in stock of the best decorative lighting products, both for indoor and outdoor use, with impeccable service, detailed quality and a strong design department.

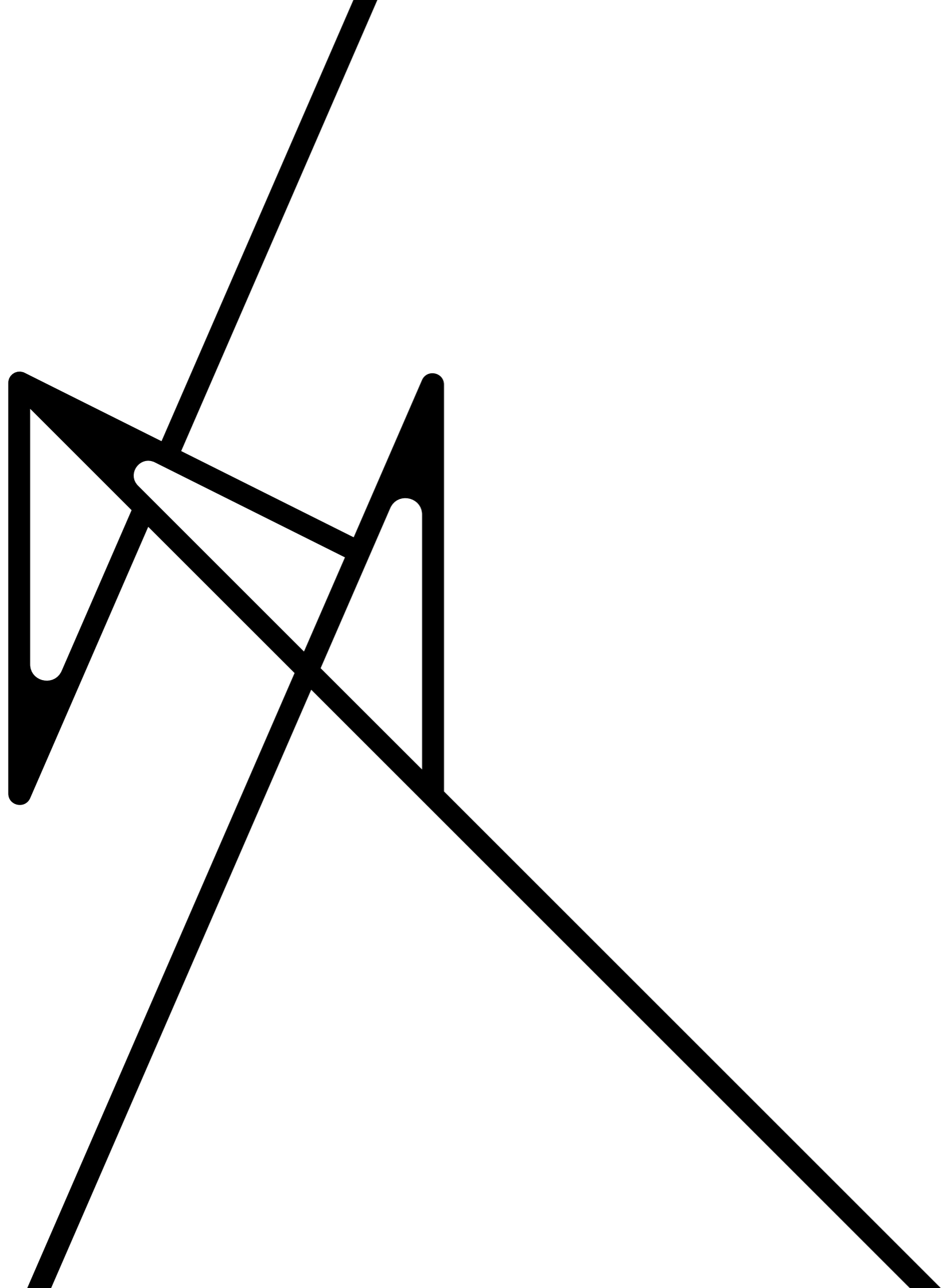

COLLECTIONS	18-283
SPOTLIGHTS	284-315
DOWNLIGHTS	316-337
PROFILE TRACK LIGHTS SYSTEM	338-361
BATHROOM LIGHTING	362-395
OUTDOOR LIGHTING	396-471
LIGHT SOURCES AND ACCESSORIES	472-479

COLLECTIONS



LASER 20-26



STALACTITE 27



EYE 28-37



EYE SUPER 38-43



MORE 44-47



IMBRIA 48-49



BATON 50-51



POLY 52



QUEBECK 53



PEAR 54-57



CYLINDER 58-59



SPHERE 60-61



CRANE 64



MONACO 62-65



VETRO 66-67



AMALFI 68-69



POLARIS 70-71



GLOBE PLUS 72-73



SALVA 74-75



NUAGE 76-79



NUNTUCET 80-81



NEWPORT 82



TESALLI 83



BOSTON 84-86



HAMPTON 87



CRISTAL 88-89



KATERINA 90



MODENA 91



TOSCANA 91



LAGUNA 92-93



TURDA 94-97



CROCO 98-99



BARREL 100



CONE 101



MIST 102



FORM 103



CAMERON 104-105



VIVIANE 106



VIOLET 107



FALCON 108



HAWK 109



VIPER 110-111



ALICE 112-115



FLEX SHADE 116



FLEX 117



RETTO 118



MOSS 119



HOTEL 120-123



CHILLIN 124-125



BORDE 126-127



VELERO 128-129



FARO 128



PETIT 130-133



CADILAC 134-135



TRIFLE 136



ZELDA 137



ROCKET 138



ACROSS 139



SUNRISE LED 142



SUNSET 140-145



SUN LED 144-145



WHEEL 146-148



WHEEL LUX 149



MINIMAL 150



DISK 151



OSLO LED 152-153



AWINION 154



COBA ANTIQUE 155



IKA 156



BIO S 157



DOVER 158-159



ORBIT 160-163



PILLS 164-165



RADIUS 166-167



ROTOR 168-171



STICKS 172-173



AXIS 174-175



ROD 176-177



PILE 178



MILL 179



MANUFACTURE 180-181



WORKSHOP 182-183



FIORD 184



TWIG 185



KAREN 234



CAMILLA 234



NESS 235



CAGE 235



ALLAN 235



MERSEY 236

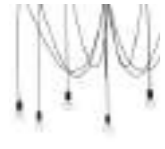

SPIDER 186-187



CABLE 188



TULUM 189



SILICONE 189



GEOMETRIC 190



SHY 190



MEKNES 236



AVEIRO 237



MARGARET 238



ARES 239



TWIST 240-241



REMBRANT LED 242-244



VOLCANO 191



LAVA 191



GIPSY 192-193



SOLID 194



SHY 195



BOLD 195



GIOTTO LED 245



IMPULSE LED 246-247



STRAIGHT CEILING LED 248-249



STRAIGHT WALL LED 250



H LED 251



SOFT LED 252-255



CRATE 196-197



PLANT 198-199



HERMANOS 200-203



ZENITH 204-205



PERM 206-207



TECHNO 208-209



WING LED 256



ION LED 257



CUBE 258



TUBE 259



LIA LED 259



GESS LED 259



PANTOGRAPH 210



CRAFT 211



HARMONY 212



HIGH-BAY 213



GARRET 214-215



HEMISPHERE RUST 216-217



BERGEN 260



HAGA 260



MALMO 261



NARWIK 261



RING LED 262-263



ORGANIC 264-265



WORKS 218



HEMISPHERE HIT 219



HEMISPHERE 220-221



EGG 222-223



CANOE 224-225



LUKSOR 226-228



KASAI 266-267



AGNES ROUND LED 268



AGNES SQUARE LED 269



STYLE LED 270-271



SMART LED 272



CHIC LED 273



WAVE 229



ABI 230



PICO 231



GSTAR 232



BULLET 233



UMBRELLA 234



POCATELLO 274-275



COSMO 276-277



PUZZLE 278-280



PLANE 281



MALWI 282-283

SPOTLIGHTS



MONO 286-307 MONO CORNER 293-295 MONO LONG 296-297 MONO SURFACE 300-305 EYE SPOT 308-311 EYE FIT 312



IRIS LED 313 CROSS 314 VESPA 315

DOWNLIGHTS



COBLE 318 GROOVE 318-319 GAP 318 PAG 318 OVAL 319 HALO 320-321



FLEA 322 POINT TONE 322 INDIA 323 MIKE 323 SET 324 EYE TONE 325-327



POINT PLEXI 328 BIT 328 POINT 329 DALE 330 DOWNLIGHT 331 BOX 331



MOD 332-333 MOD PLUS 333 EYE MOD 334 DOT 335 CL KOS LED 336-337

PROFILE TRACK LIGHT SYSTEM



PROFILE IRIS LED 340-343 PROFILE STORE PRO LED 344-345 PROFILE MIKE 346 PROFILE INDIA 346 PROFILE FOCUS LED 346 PROFILE ZOOM LED 347



PROFILE EYE SUPER 350 PROFILE EYE FLEX 350 PROFILE EYE 351 PROFILE BIT 351 PROFILE WORKSHOP 351 PROFILE EYE SPOT 353



PROFILE VESPA 353 PROFILE BIT PLUS 353 PROFILE TRACK 354 PROFILE POWER SUPPLY KIT 354 PROFILE SUSPENSION KIT 354 PROFILE STRAIGHT CONNECTOR 356



PROFILE FLEX CONNECTOR 356 PROFILE L CONNECTOR 357 PROFILE T CONNECTOR 357 PROFILE X CONNECTOR 357 PROFILE POWER END CAP 357 PROFILE DEAD END CAP 357

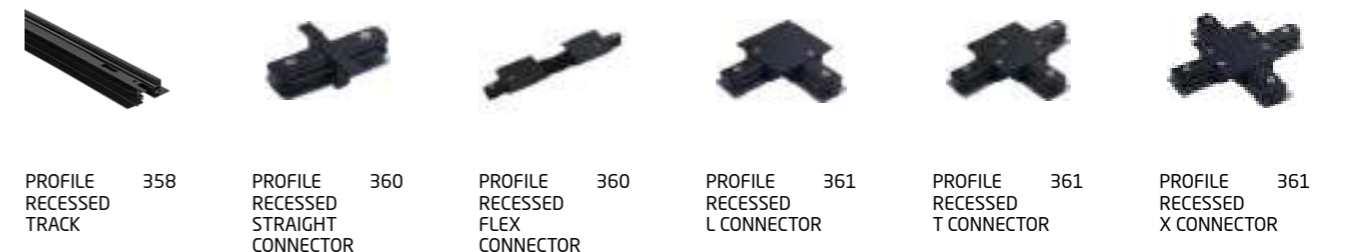































PROFILE RECESSED TRACK 358 PROFILE RECESSED STRAIGHT CONNECTOR 360 PROFILE RECESSED FLEX CONNECTOR 360 PROFILE RECESSED L CONNECTOR 361 PROFILE RECESSED T CONNECTOR 361 PROFILE RECESSED X CONNECTOR 361







































PROFILE RECESSED POWER END CAP 361 PROFILE RECESSED DEAD END CAP 361 PROFILE RECESSED FIXING SET 361

BATHROOM LIGHTING

					
ICE EGG 364-365	PIN LED 366-367	VAN GOGH 368-369 LED	PICASSO LED 370	LATH LED 370	KAGERA LED 371
					
VISTA 372	PAN LED 373	CAVO 374	SIS 375	BALI 376	CELTIC 377
					
BRAZOS 378-379	SIMI 379	ICE TUBE 380-381 LED	ICE BALL 382-383	TORCH 383	BASSA LED 385
					
MALAKKA 384-385 LED	ARENA 386-387	BRAVO 388	ALPHA 388-389	CHARLIE 392	DELTA 392
					
GOLF 393	ECHO 393	FOXTROT 394	JULIET 395	HELIOS LED 395	EOL LED 395

OUTDOOR LIGHTING

					
CUMULUS 398-401	FLOWERPOT 402-403	CUMULUS CUBE 404	STAR 405	GALAXY 405	STRUCTURE 406-407 LED
					
SYMMETRY 408-409 LED	OTTAWA 410	SOUL 411	TUBINGS 412-415	SPIKE LED 416	BUSH 417
					
THIKA LED 418-419	RIO 420-421	ROCK 422	FOG 423	NEGRO 424	EXE 425
					
SIERRA 426	BRIC 427	ORINOKO 427	UNIT LED 427	MEKONG 428	MISTRAL 429
					
AMUR 430	TYBR 431	TAY 432	SPEY 433	LANTERN 434	DON 434
					
QUARTZ 435	INDUS 435	LHOTSE LED 436	POLE LED 436	TEPIC LED 437	MONTERREY 437 LED



NORIN 438 HORN 438 OIR 439 SIROCCO 439 PATHWAY FOUNDATION KIT 440 PATHWAY LED 440-441



PICNIC LED 466-467 HANGING SET FOR PICNIC LED 466 MAHE LED 468-469 POWER CORD FOR FESTOON LIGHTS 471 FESTOON LIGHTS 470-471



PUEBLA LED 442 MERIDA LED 442 HEXA 443 LENS LED 446 EDESA LED 447 NOOK 448-450

LIGHT SOURCES AND ACCESSORIES



TAHOE 451 ZOA LED 452 SINUS 453 PATRAS LED 453 MUNO LED 453 ELLIPSES LED 454



REFLECTOR COB LED, GU10, ES111, 15W 474 REFLECTOR LENS LED, GU10, ES111, 9W 474 REFLECTOR DIFFUSER LED, GU10, ES111, 9W 474 BULB LED G9, 7W 475 BULB LED G9, 4W 475 BULB LENS LED, G9, 3W 475



TRIANGLES LED 454 LIMA LED 455 KHUMBU 455 ASSOS 456 ARRIS 457 NICO 457



REFLECTOR LED, GU10, R50, 7W 475 BULB LED, GX53, 8W 476 BULB GLASS BALL LED, E27, 8W 476 BULB LED, E27, A60, 2W, 5 PC SET 476 BULB VINTAGE LED, E14, 4W 477 BULB VINTAGE LED, E27, 4W 477



PEAK LED 458 DRAS LED 458 SEMI LED 458 PRIMM 459 FALLON 459 BAY LED 460



BULB VINTAGE LED, E27, 4W 477 BULB VINTAGE LED, E27, 4W 477 BULB VINTAGE LED, E27, 4W 477 TUBE LED T8 478 WATERPROOF CONNECTOR IP68 479 WATERPROOF CONNECTOR IP 68 479



SIDEWALK ROUND LED 461 SIDEWALK SQUARE LED 461 BASALT 462 ASSAM 462 INA 462 STEP LED 463



MICROWAVE SENSOR 479 DUPLEX 479



OIA LED 463 PICCO LED 464 PAOLI 465 MON LED 465 PAT LED 465 CIRCLER LED 465

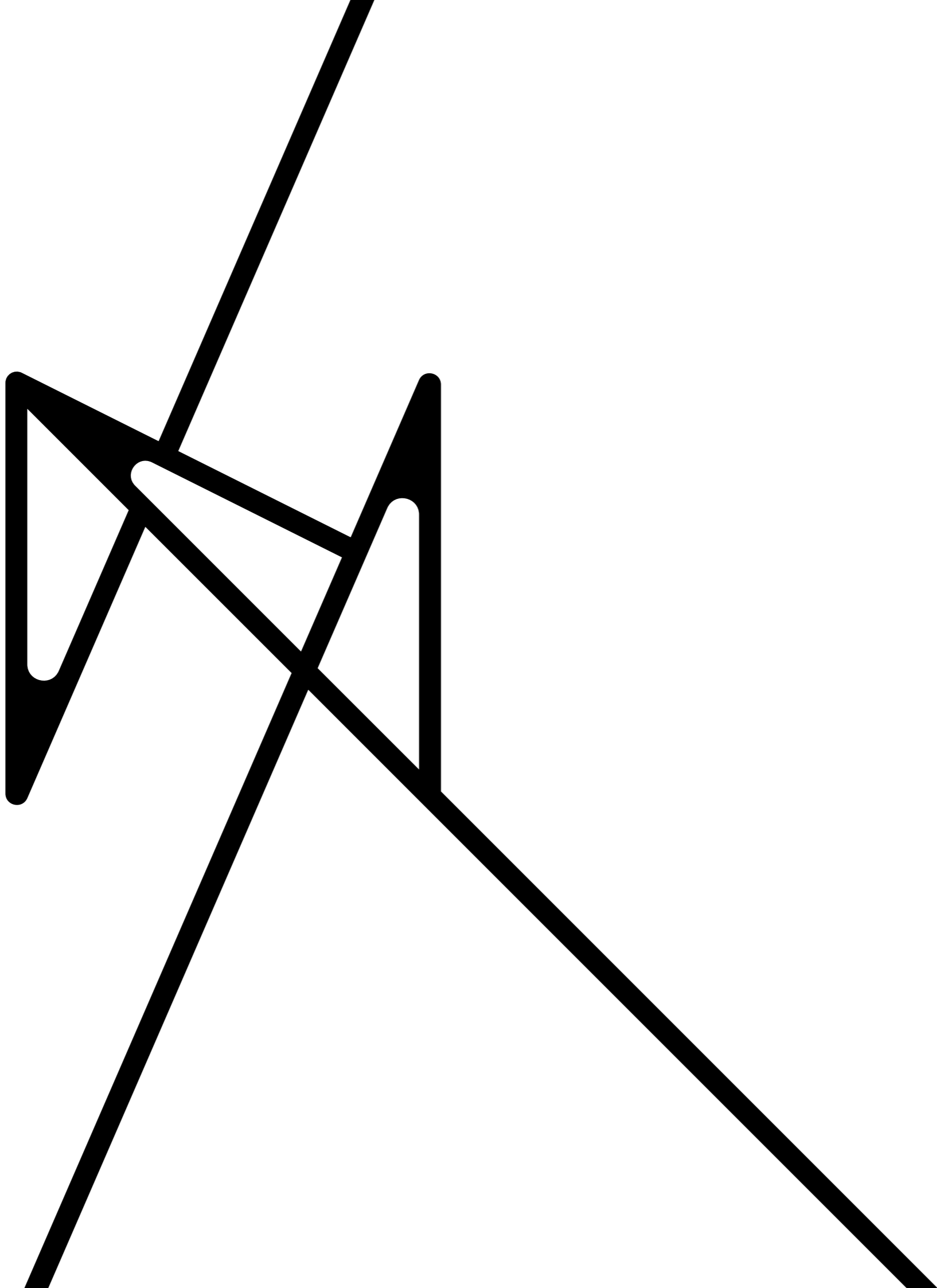

Collections

LASER 1000 7668

LASER 8308





LASER 490 8922



LASER 1000 7668

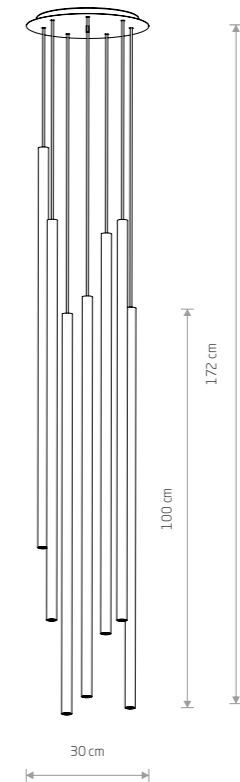

LASER 1000

■ painted steel

■ 7667

● 7xG9, max 10W only LED

■ solid brass, painted steel

■ 7668

● 7xG9, max 10W only LED

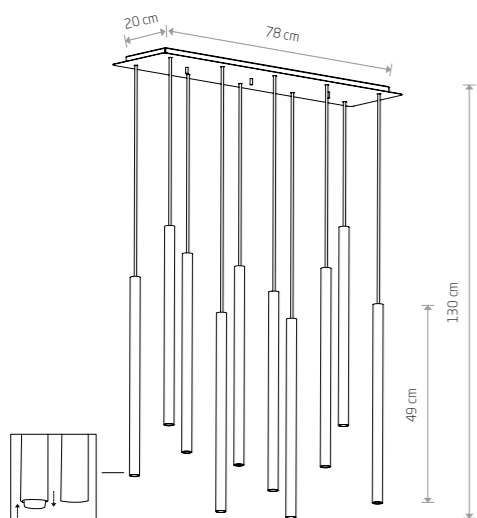

LASER 490

■ painted steel

■ 8922 ■ 8923

● 10xG9, max 10W only LED

■ solid brass, painted steel

■ 8924

● 10xG9, max 10W only LED

LASER 490

■ painted steel

■ 8918 ■ 8920

● 7xG9, max 10W only LED

■ solid brass, painted steel

■ 8921

● 7xG9, max 10W only LED

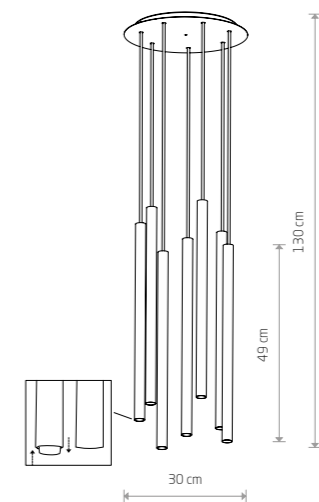

LASER 490 8920





LASER 750 8433

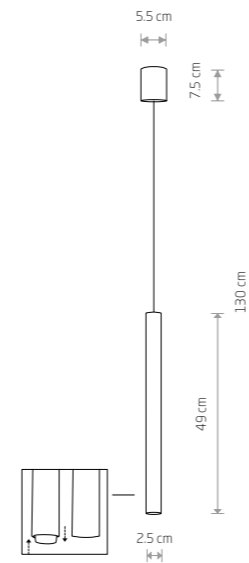

LASER 490

painting steel

8796 8797

1xG9, max 10W only LED

solid brass, painting steel

8798

1xG9, max 10W only LED

LASER 490 8796

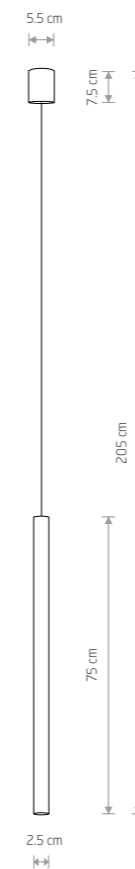

LASER 750

painting steel

8432 8433

1xG9, max 10W only LED

solid brass, painting steel

8431

1xG9, max 10W only LED

LASER 750 8433

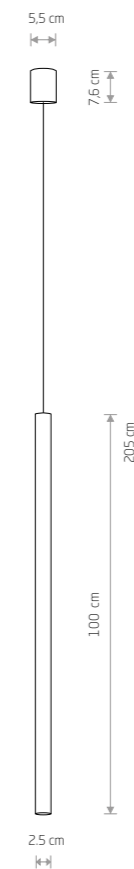

LASER 1000

painting steel

8435 8436

1xG9, max 10W only LED

solid brass, painting steel

8434

1xG9, max 10W only LED

LASER 1000 8434

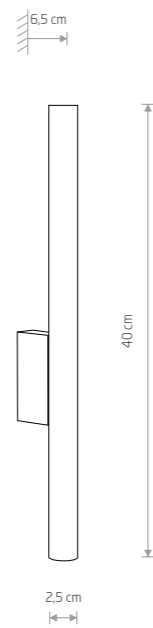

LASER
painted steel

- 8048 8047
- 2xG9, max 10W only Led
- solid brass, painted steel
- 8308
- 2xG9, max 10W only LED



STALACTITE 9054



STALACTITE 9055



STALACTITE 8352

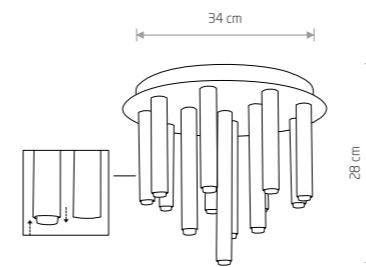

STALACTITE
painted steel

- 8355 8356
- 13xG9, max 10W only LED
- solid brass, painted steel
- 9054
- 13xG9, max 10W only LED

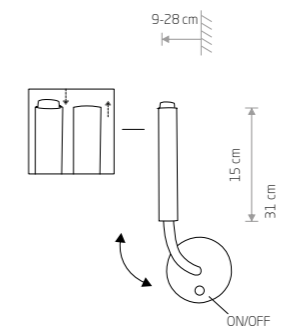

STALACTITE
painted steel, flexible stem

- 8351 8350
- 1xG9, max 10W only LED
- solid brass, painted steel, flexible stem
- 8352
- 1xG9, max 10W only LED

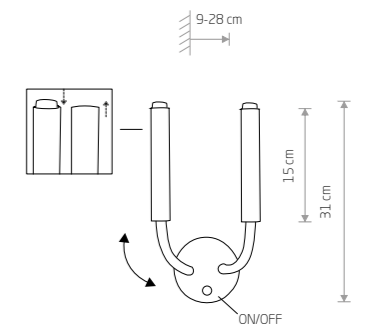

STALACTITE
painted steel, flexible stem

- 8353 8354
- 2xG9, max 10W only LED
- solid brass, painted steel, flexible stem
- 9055
- 2xG9, max 10W only LED



EYE M 5397

EYE L 6841

EYE L 8800

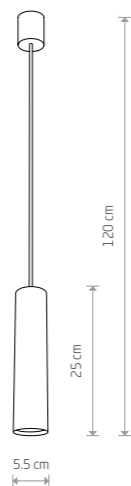

EYE M

painted steel

5397 5400

5398 6840

1xGU10, max 10W only LED

solid brass, painted steel

8914

1xGU10, max 10W only LED

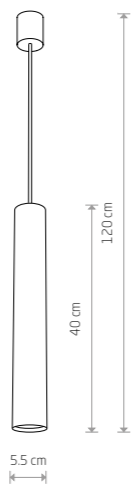

EYE L

painted steel

5455 5456

6841

1xGU10, max 10W only LED

solid brass, painted steel

8800

1xGU10, max 10W only LED



EYE 7863

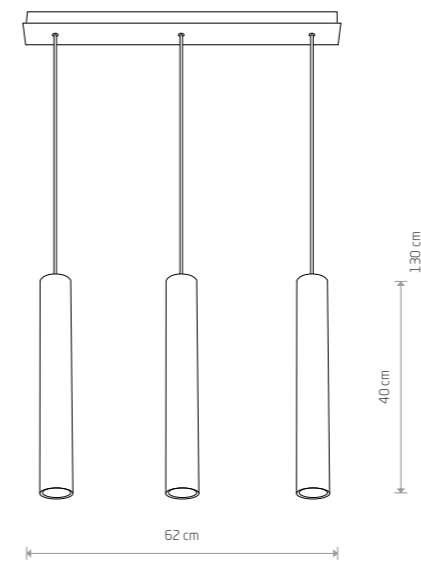

EYE

painted steel

6481 7862

3xGU10, max 10W only LED

solid brass, painted steel

7863

3xGU10, max 10W only LED



EYE L 8917



EYE L 8916

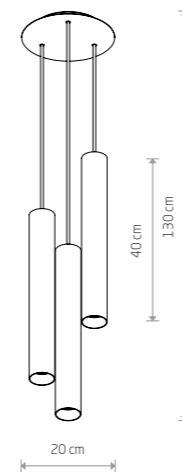

EYE L
painted steel

8916 8917

3xGU10, max 10W only LED

solid brass, painted steel

8915

3xGU10, max 10W only LED



EYE L 8915



EYE L 6838



EYE M 5464



EYE S 5255

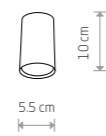

EYE S

painting steel

5255 5257

5256 6836

1xGU10, max 35W

solid brass

8911

1xGU10, max 35W

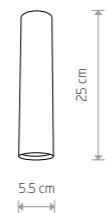

EYE M

painting steel

5463 5464 6837

1xGU10, max 35W

solid brass

8912

1xGU10, max 35W



EYE L

painting steel

5471 5472 6838

1xGU10, max 35W

solid brass

8913

1xGU10, max 35W

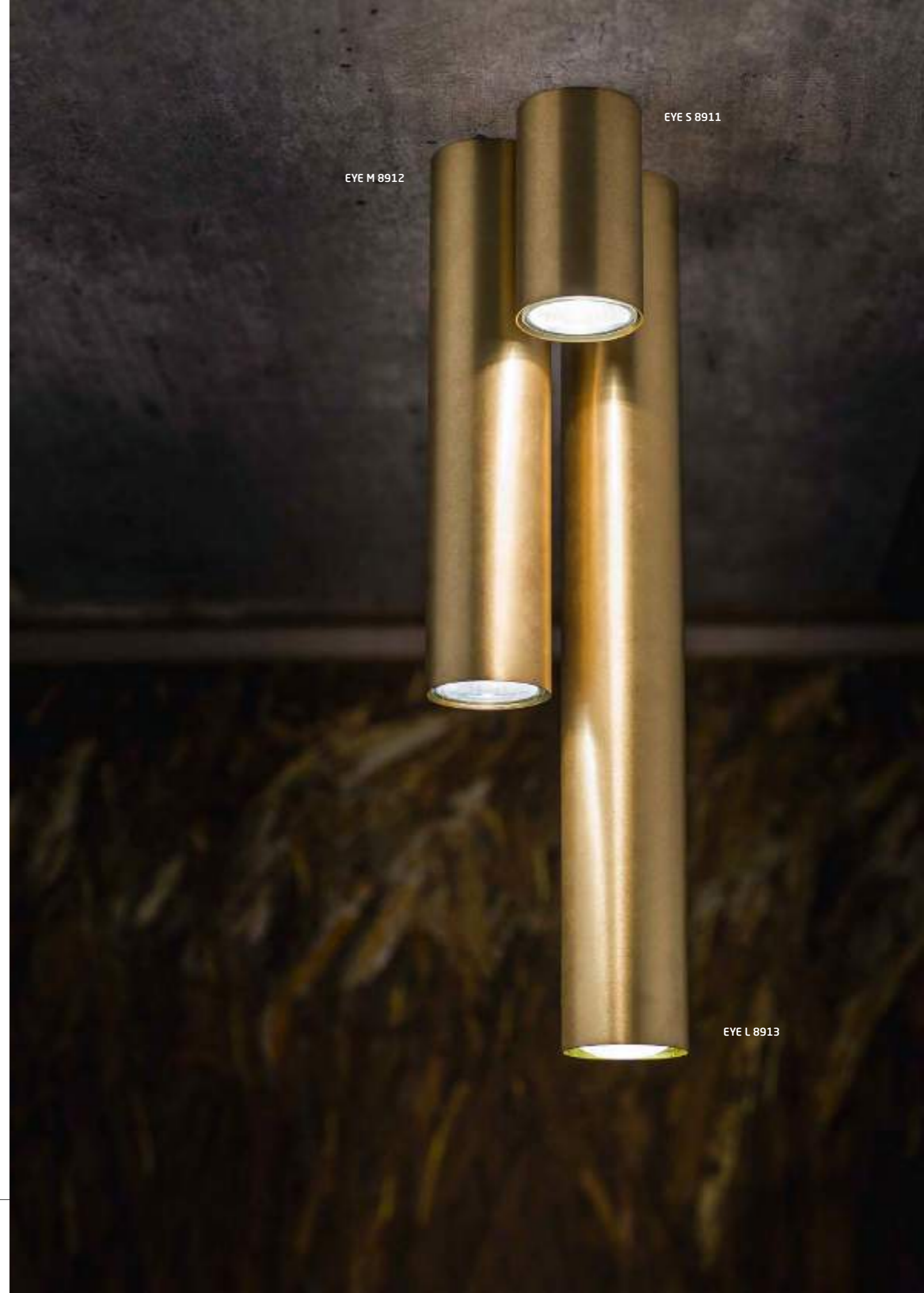

EYE S 8911

EYE M 8912

EYE L 8913

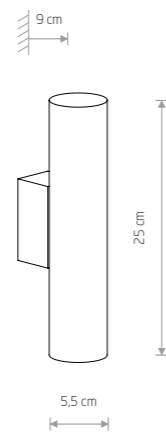

EYE WALL

■ painted steel

- 8073 ■ 8072

■ 2xGU10, max 10W only LED

■ solid brass, painted steel

- 8074

■ 2xGU10, max 10W only LED

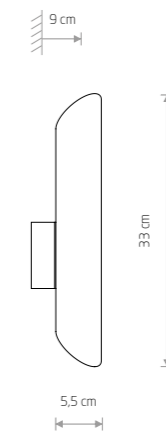

EYE WALL CUT

■ painted steel

- 7993 ■ 7994

■ 2xGU10, max 10W only LED

■ solid brass, painted steel

- 7995

■ 2xGU10, max 10W only LED



EYE FLEX S 9068

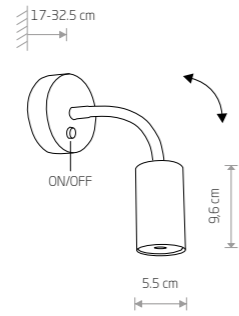

EYE FLEX S

painting steel, flexible stem

9070 9068

1xGU10, max 10W only LED

solid brass, flexible stem, painting steel

9067

1xGU10, max 10W only LED



EYE FLEX S 9067



EYE FLEX 8935

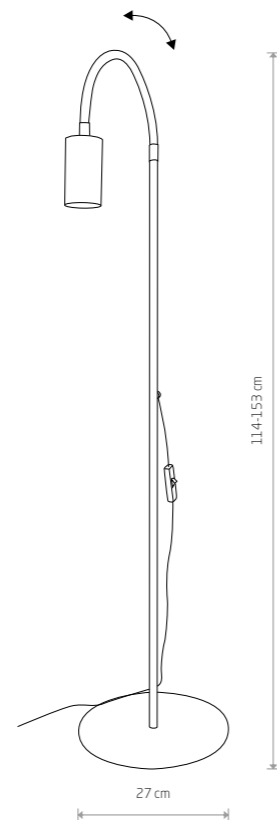

EYE FLEX

painting steel, flexible stem

8934 8935

1xGU10, max 10W only LED

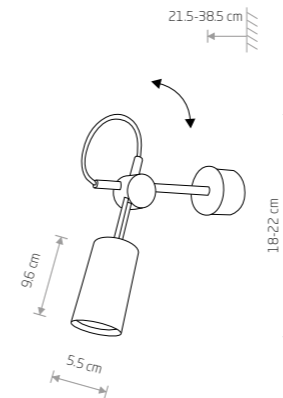

EYE

painting steel

5654 5655 6842

1xGU10, max 35W



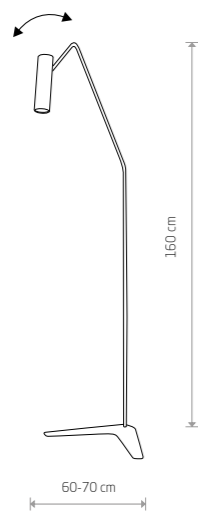

EYE SUPER
 painted steel

6493 6500 6506

1xGU10, max 35W

EYE SUPER 6506





EYE SUPER 6501

EYE SUPER A 6495

8 cm
3 cm
48-58 cm
20 cm
5.5 cm

EYE SUPER A
painted steel

6488 6495 6502

1xGU10, max 35W

EYE SUPER B 6490

8 cm
3 cm
68-76.5 cm
20 cm
5.5 cm

EYE SUPER B
painted steel

6490 6496 6503

1xGU10, max 35W

EYE SUPER 6494

44-55 cm
61-65 cm

EYE SUPER
painted steel, chrome

6487 6494 6501

1xGU10, max 35W

EYE SUPER 6497

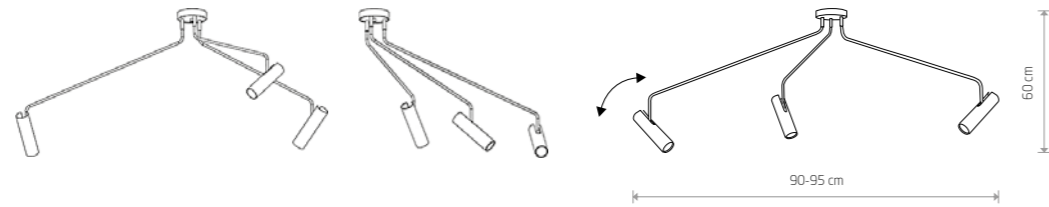
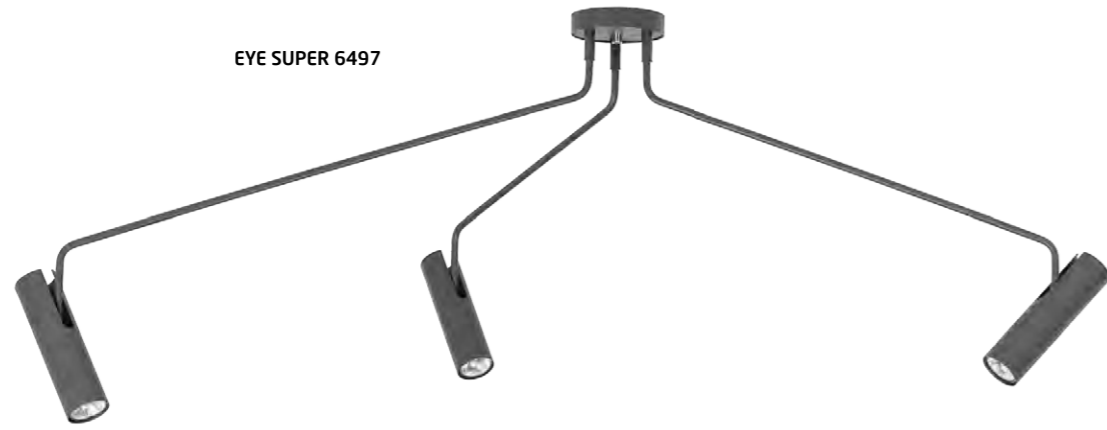

EYE SUPER

painting steel, chrome

6491 6497 6504

3xGU10, max 35W

EYE SUPER 6505

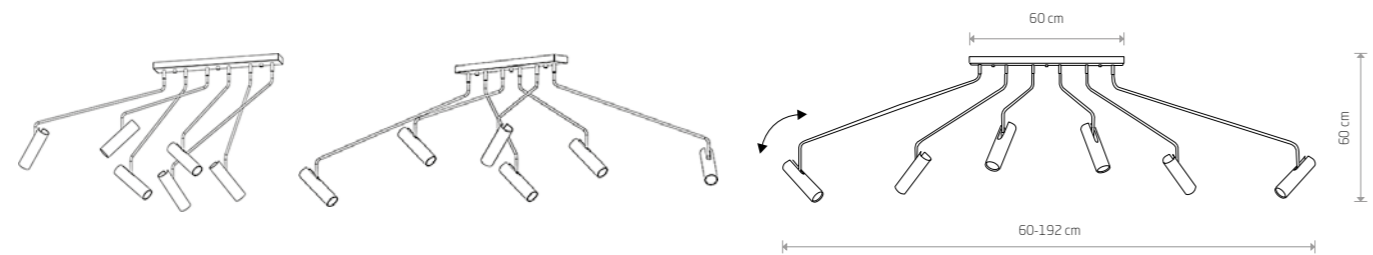
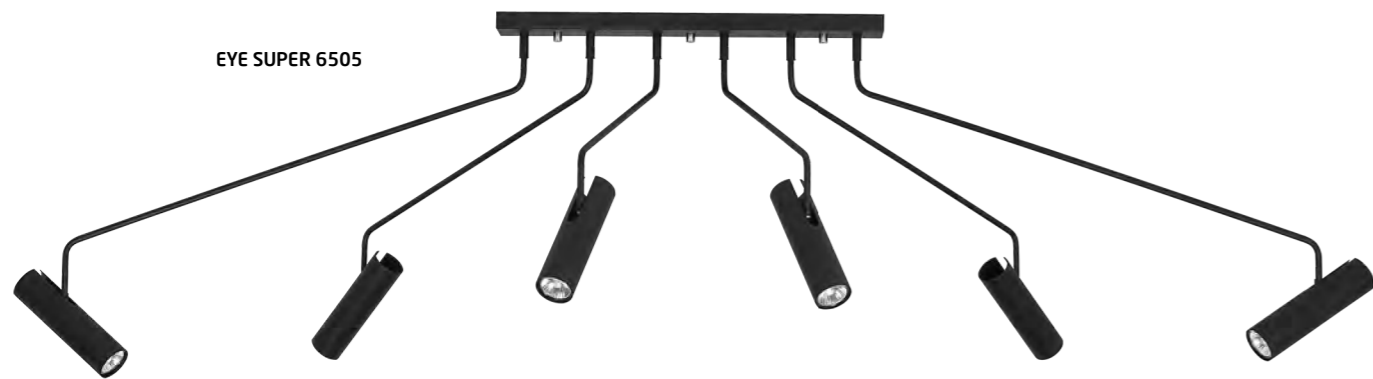

EYE SUPER

painting steel, chrome

6492 6498 6505

6xGU10, max 35W

WHITE P004 RAL 9003 GRAPHITE P010 RAL 7016 BLACK P013 RAL 9005

EYE SUPER 6505





MORE TONE 7821

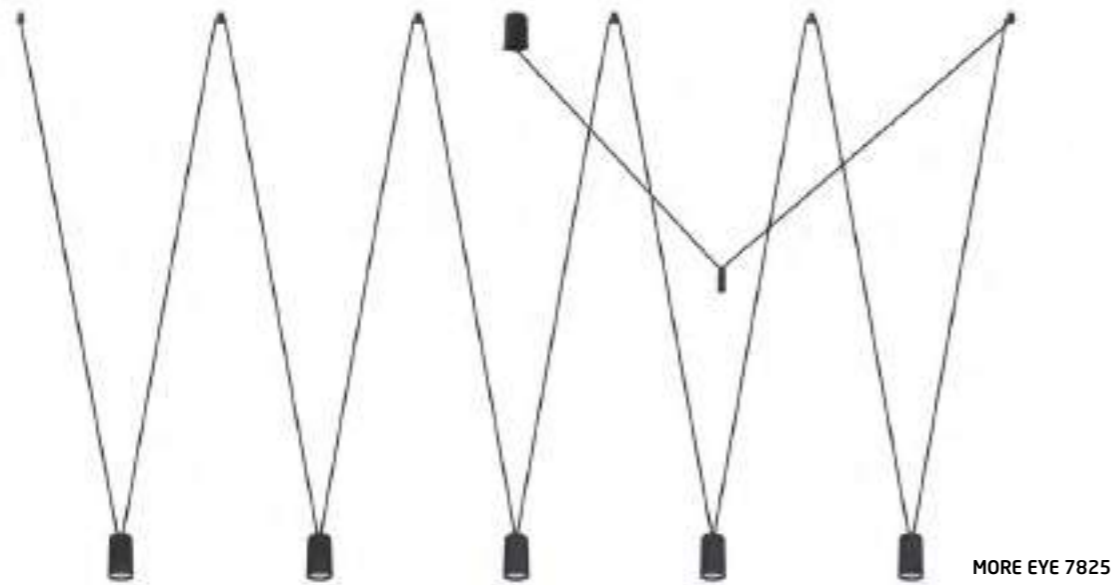

MORE EYE 7825



MORE TONE 7817

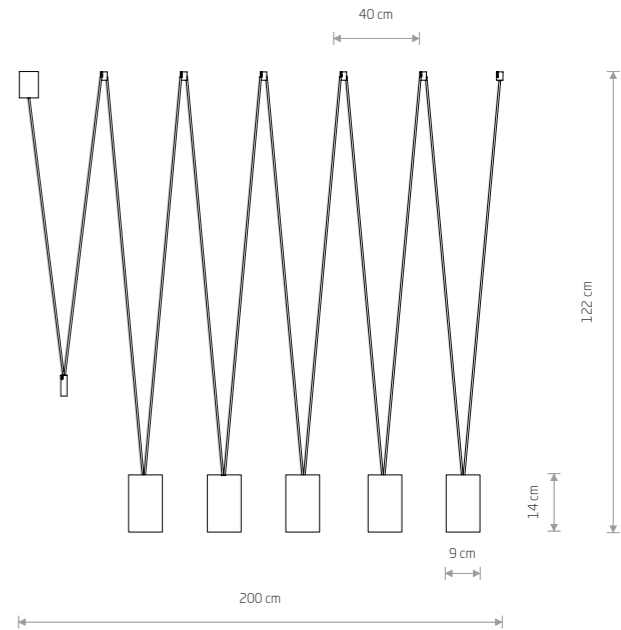
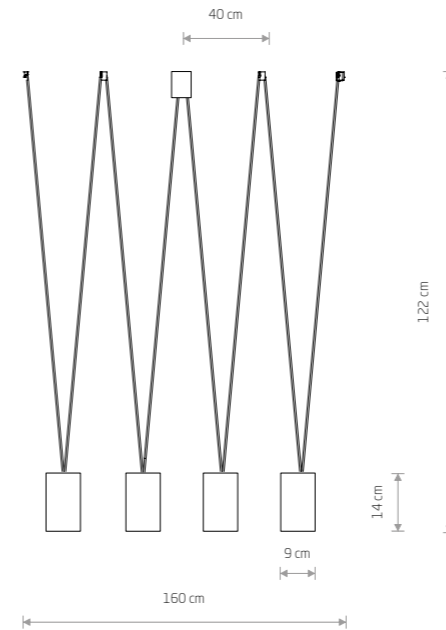
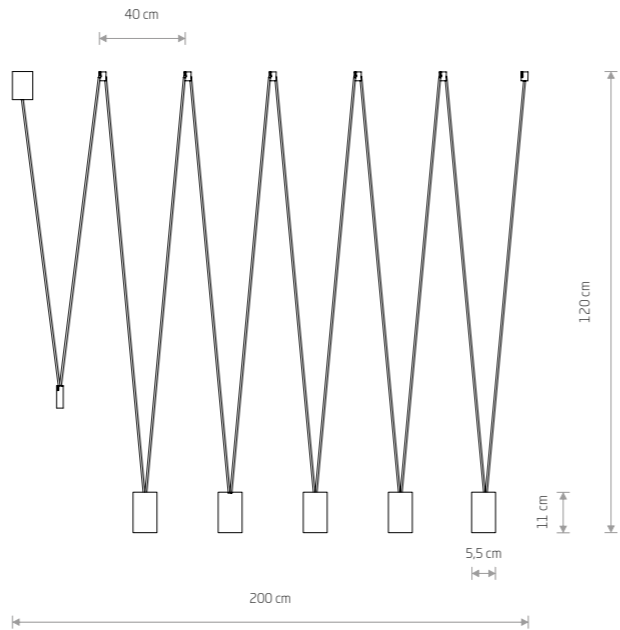
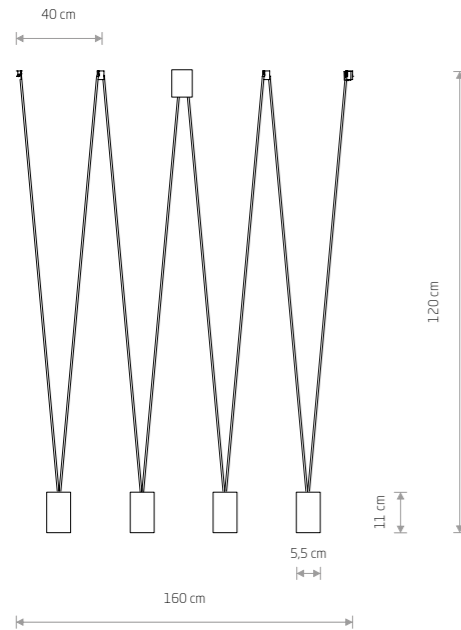

MORE EYE

painting steel

- 7824
- 7822

4xGU10, max 10W only LED

solid brass, painting steel

- 7610

4xGU10, max 10W only LED

MORE EYE

painting steel

- 7826
- 7825

5xGU10, max 10W only LED

solid brass, painting steel

- 7608

5xGU10, max 10W only LED

MORE TONE

painting steel, plastic ABS

- 7816
- 7814

4xGU10, max 10W only LED

MORE TONE

painting steel, plastic ABS

- 7821
- 7817

5xGU10, max 10W only LED



IMBRIA 9677

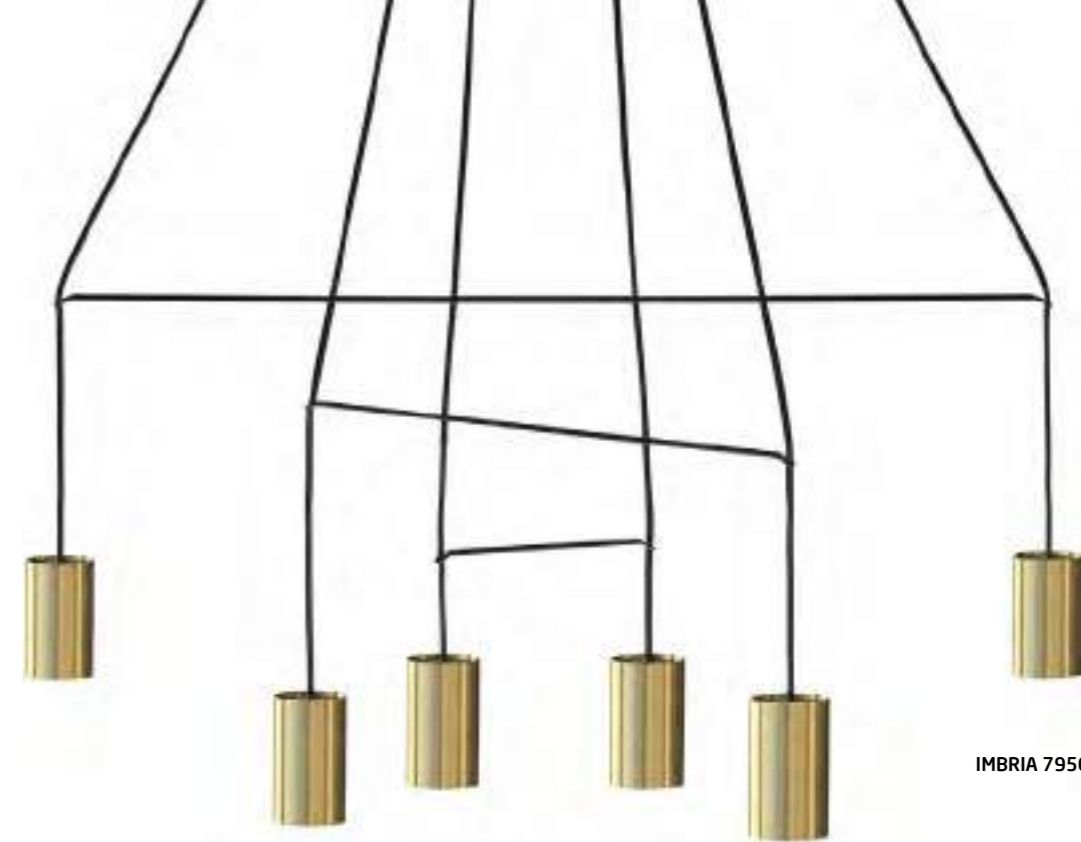

IMBRIA 7956

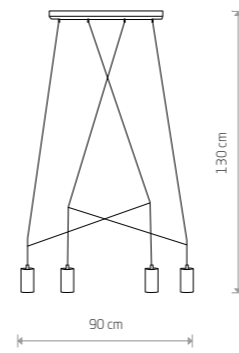

IMBRIA
 painted steel, braided cable
 9191 9192
 4xGU10, max 35W
 solid brass, braided cable, painted steel
 7957
 4xGU10, max 10W only LED

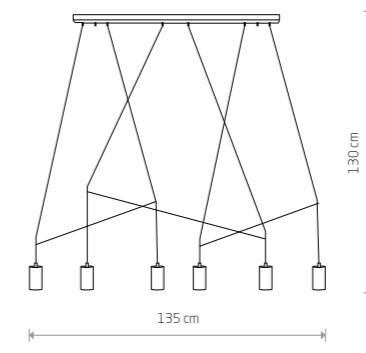

IMBRIA
 painted steel, braided cable
 9674 9675
 6xGU10, max 35W
 solid brass, braided cable, painted steel
 7955
 6xGU10, max 10W only LED

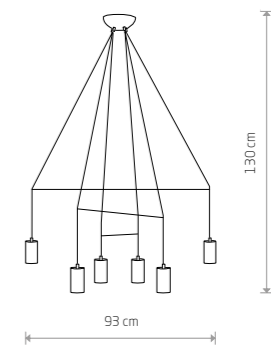

IMBRIA
 painted steel, braided cable
 9676 9677
 6xGU10, max 35W
 solid brass, braided cable, painted steel
 7956
 6xGU10, max 10W only LED

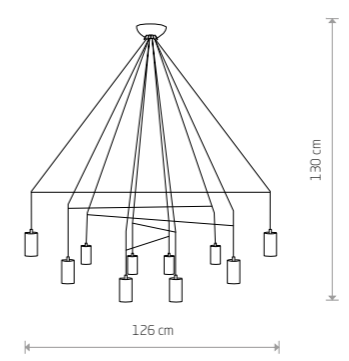

IMBRIA
 painted steel, braided cable
 9680
 10xGU10, max 35W
 solid brass, braided cable, painted steel
 7954
 10xGU10, max 10W only LED



BATON 7856

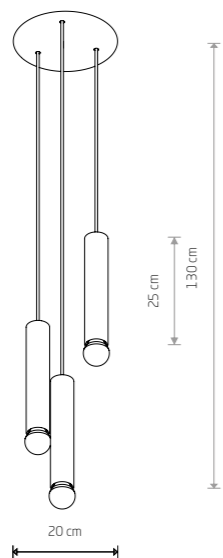

BATON

■ painted steel

■ 7852

● 1xE27, max 10W only LED

■ solid brass, painted steel

■ 7851

● 1xE27, max 10W only LED

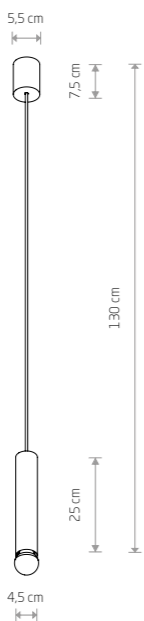

BATON 7852



BATON 7851

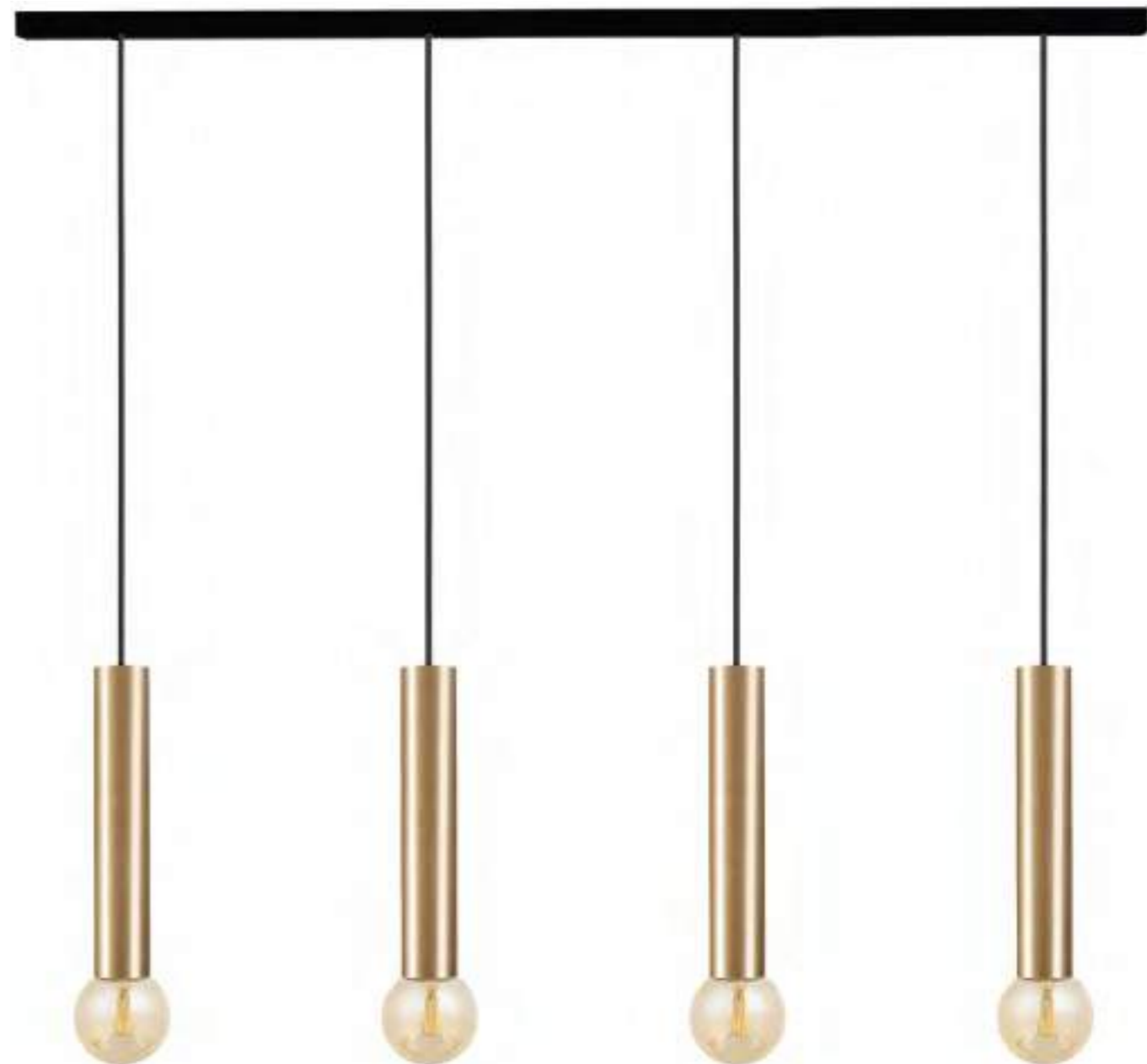

BATON 7853

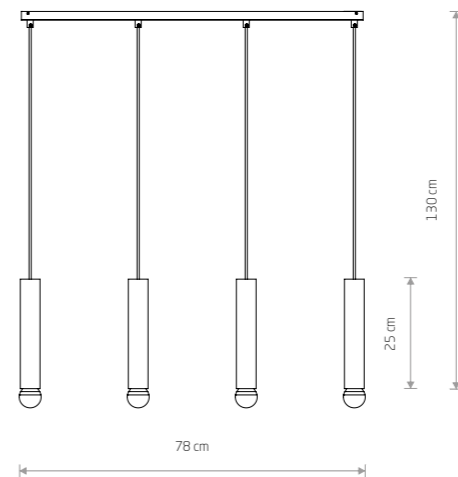

BATON

■ painted steel

■ 7854

● 4xE27, max 10W only LED

■ solid brass, painted steel

■ 7853

● 4xE27, max 10W only LED



POLY 8885



POLY 8884

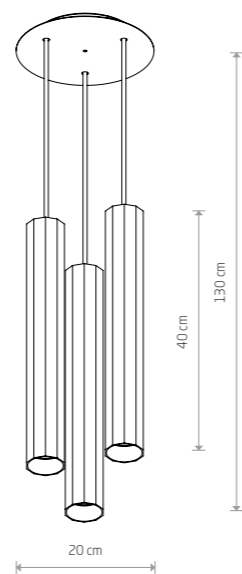

POLY
painted aluminum, painted steel

8884 8885

3xGU10, max 10W only LED



QUEBECK 5404

QUEBECK 5405

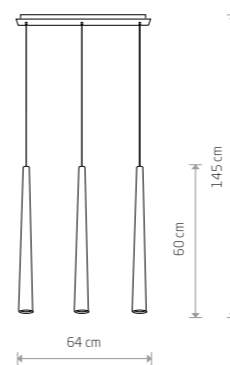

QUEBECK
painted aluminum, painted steel

5404 5406

3xGU10, max 35W

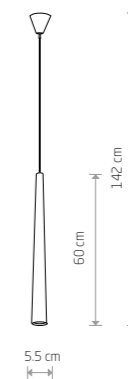

QUEBECK
painted aluminum, painted steel

5403 5405

1xGU10, max 35W



PEAR S 8673

PEAR L 8671

PEAR M 8672

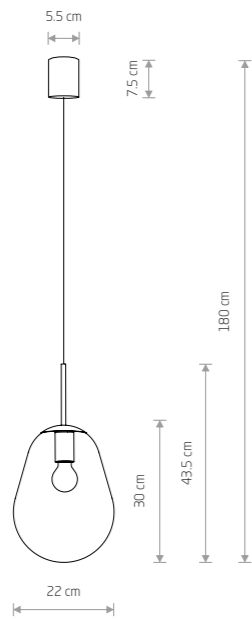

PEAR S

glass, brass-plated steel, painted steel

8673

1xE27, max 40W

glass, painted steel

7800

1xE27, max 40W

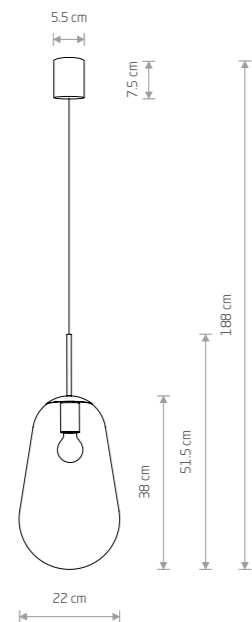

PEAR M

glass, brass-plated steel, painted steel

8672

1xE27, max 40W

glass, painted steel

7798

1xE27, max 40W

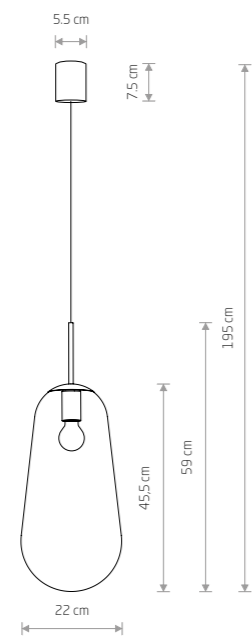

PEAR L

glass, brass-plated steel, painted steel

8671

1xE27, max 40W

glass, painted steel

7797

1xE27, max 40W

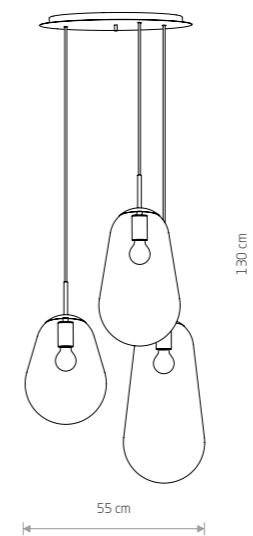

PEAR

glass, brass-plated steel, painted steel

7794

3xE27, max 40W



CYLINDER L 7864

CYLINDER M 7865

CYLINDER S 7866

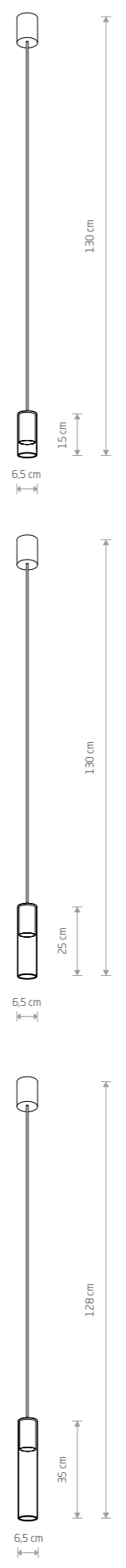

CYLINDER S

- glass, painted steel
- 7866
- 1xGU10, max 10W only LED
- glass, solid brass, painted steel
- 7870
- 1xGU10, max 10W only LED

CYLINDER M

- glass, painted steel
- 7865
- 1xGU10, max 10W only LED
- glass, solid brass, painted steel
- 7868
- 1xGU10, max 10W only LED

CYLINDER L

- glass, painted steel
- 7864
- 1xGU10, max 10W only LED
- glass, solid brass, painted steel
- 7867
- 1xGU10, max 10W only LED

TRANSPARENT
 BLACK P013 RAL 9005
 BRASS



CYLINDER M 7868

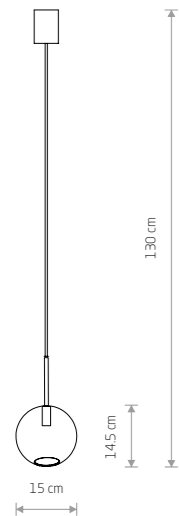

SPHERE S
glass, painted steel

7847
1xG9, max 10W

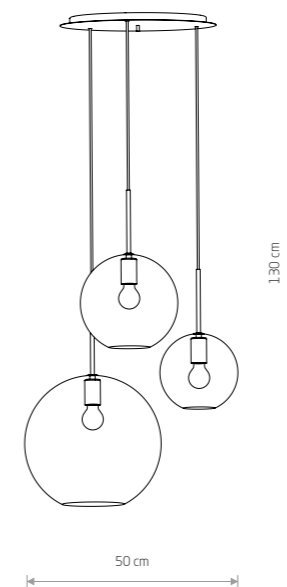

SPHERE
glass, painted steel

7788
3xE27, max 40W

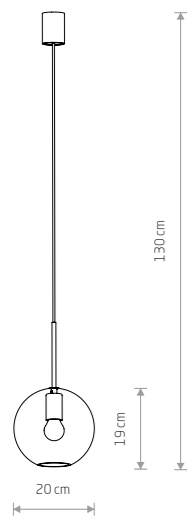

SPHERE M
glass, painted steel

7848
1xE27, max 40W

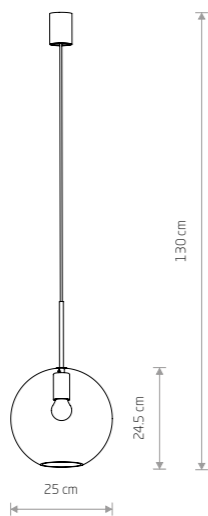

SPHERE L
glass, painted steel

7850
1xE27, max 40W

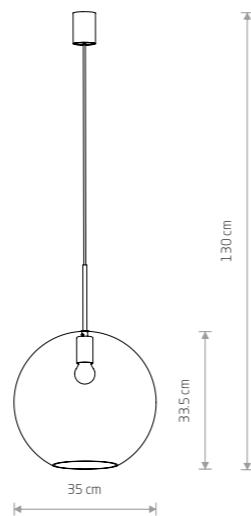

SPHERE XL
glass, painted steel

7846
1xE27, max 40W



MONACO 9363

CRANE 9374

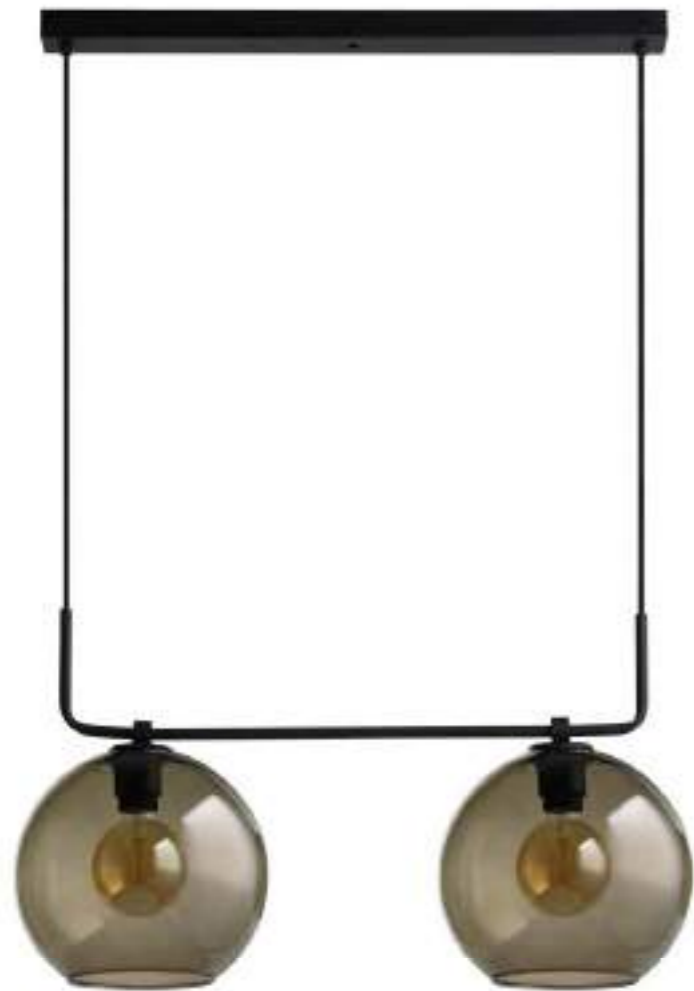

MONACO 9363

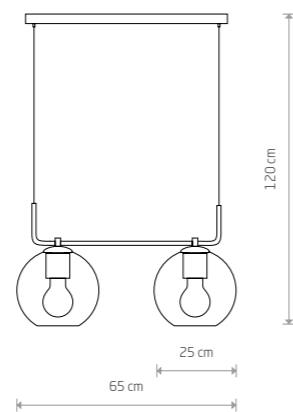

MONACO

glass, braided cable, painted steel

■ 9363

● 2xE27, max 60W

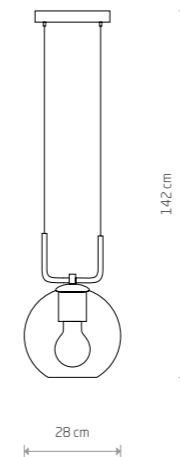

MONACO

glass, braided cable, painted steel

■ 9364

● 1xE27, max 60W



MONACO 9364

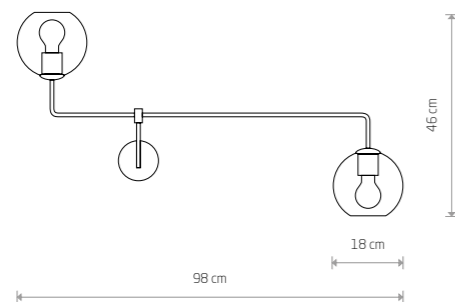

MONACO

glass, painted steel

■ 9362

● 2xE27, max 60W

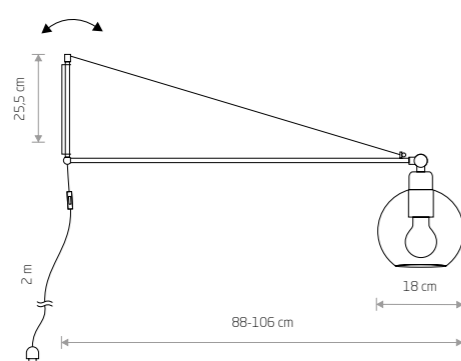

CRANE

glass, painted steel, solid brass

■ 9374

● 1xE27, max 60W

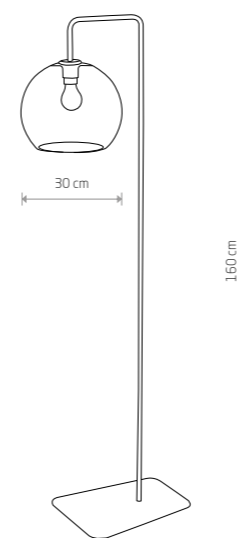

MONACO

painted steel, glass

■ 8794

● 1xE27, max 60W

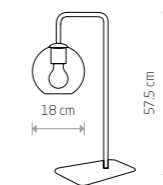

MONACO

glass, painted steel

■ 9308

● 1xE27, max 60W



MONACO 9308

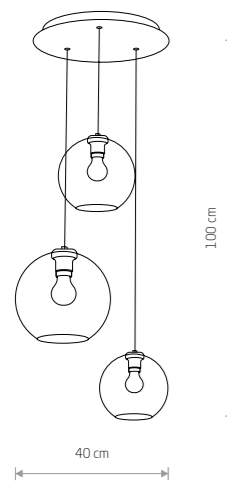

VETRO
glass, painted steel

■ 7641
● 3xE27, max 60W

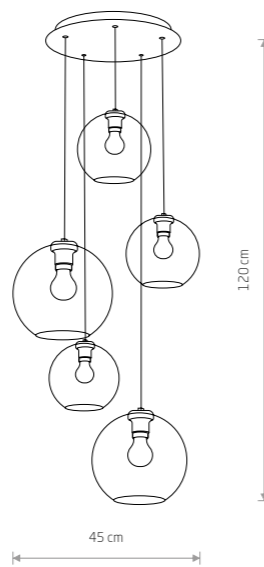

VETRO
glass, painted steel

■ 7642
● 5xE27, max 60W

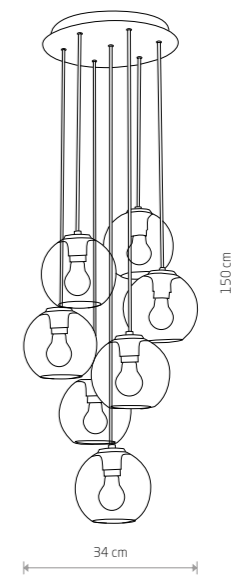

VETRO
glass, painted steel

■ 9131
● 7xE27, max 60W

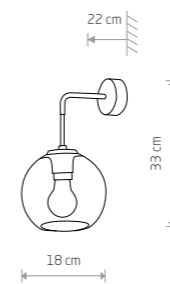

VETRO
glass, painted steel

■ 9132
● 1xE27, max 60W



AMALFI M 9153



AMALFI 9155



AMALFI 9154

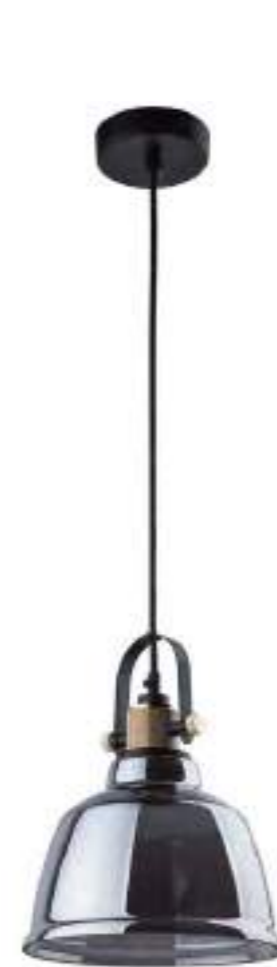

AMALFI M 9152



AMALFI L 8381

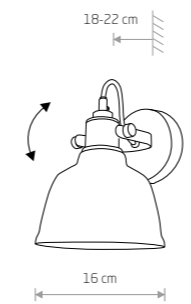

AMALFI
metallized glass, steel, solid brass

- 9154 9155

1xE27, max 60W

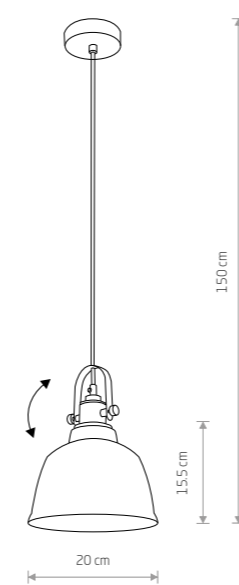

AMALFI M
metallized glass, steel, solid brass

- 9152 9153

1xE27, max 60W

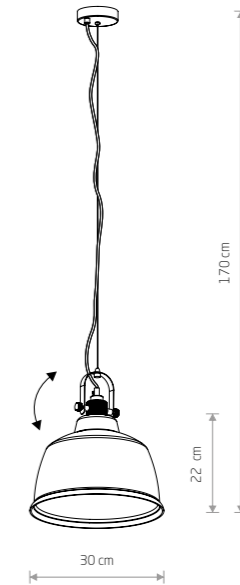

AMALFI L
metallized glass, steel, solid brass

- 8380 8381

1xE27, max 40W

GOLD SILVER BLACK



POLARIS 9060



POLARIS 9057



POLARIS 9058



POLARIS 9056

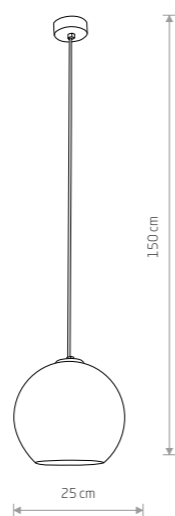

POLARIS
metallized glass, painted steel

- 9060
- 1xE27, max 60W

POLARIS
metallized glass, painted steel

- 9056
- 9057
- 9058
- 1xE27, max 60W

- SMOKED
- GOLD
- COPPER
- CHROME
- BLACK P013 RAL 9005



POLARIS 9057

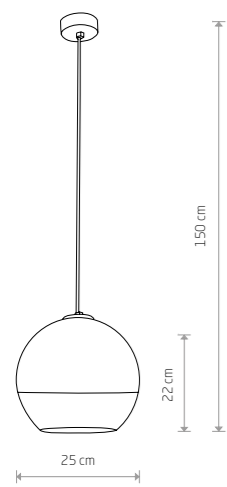

GLOBE PLUS M
metallized glass, painted steel

- 7606
- 1xE27, max 60W

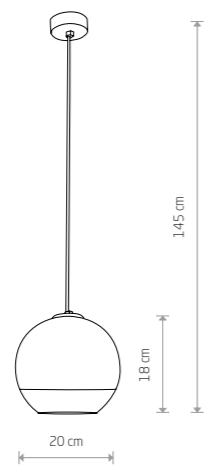

GLOBE PLUS S
metallized glass, painted steel

- 7605
- 1xE27, max 60W

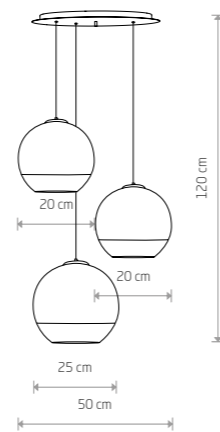

GLOBE PLUS
metallized glass, painted steel

- 7607
- 3xE27, max 60W

■ CHROME ■ BLACK P013 RAL 9005



GLOBE PLUS M 7606

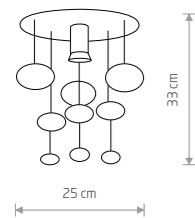

SALVA A
glass, stainless steel

5422
1xGU10, max 35W

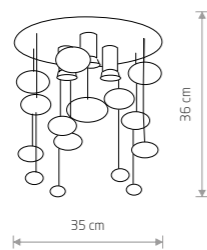

SALVA C
glass, stainless steel

5424
3xGU10, max 35W

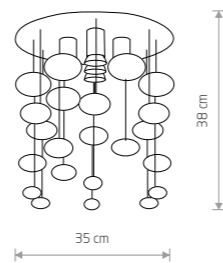

SALVA E
glass, stainless steel

5428
5xGU10, max 35W

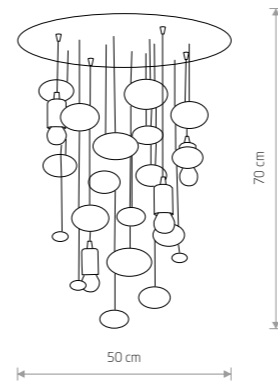

SALVA G
glass, stainless steel

6845
4xE27, max 60W

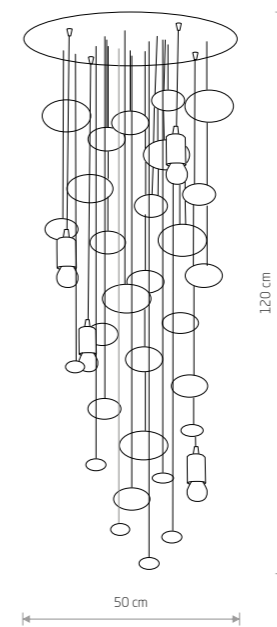

SALVA H
glass, stainless steel

6846
4xE27, max 60W



NUAGE S 7024

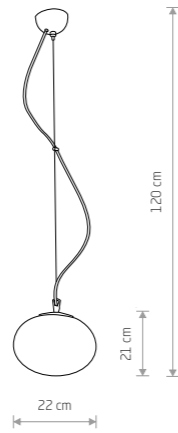

NUAGE S
glass, chrome plated steel

7024
1xE27, max 60W



NUAGE L 7026

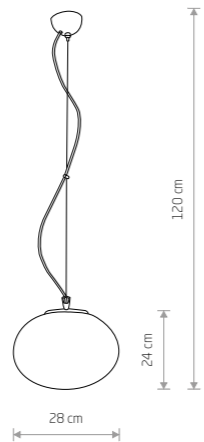

NUAGE M
glass, chrome plated steel

7025
1xE27, max 60W

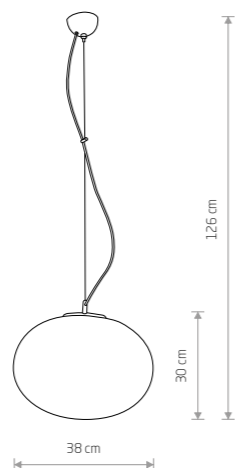

NUAGE L
glass, chrome plated steel

7026
1xE27, max 60W



NUAGE 7027

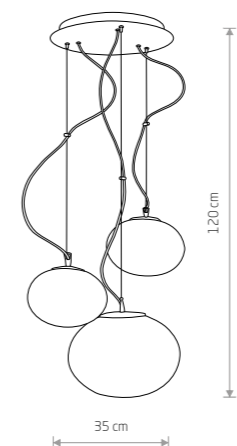

NUAGE
glass, chrome plated steel

7027
3xE27, max 60W

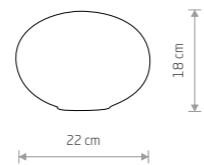

NUAGE S

glass

7021

1xE27, max 60W

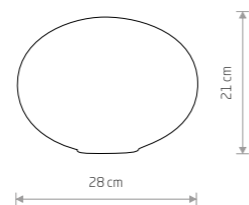

NUAGE M

glass

7022

1xE27, max 60W



NUAGE 9272

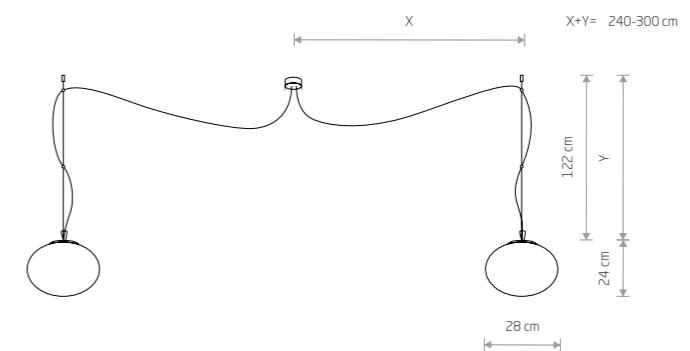

NUAGE

glass, chrome plated steel

9272

2xE27, max 60W



NUNTUCET 8150

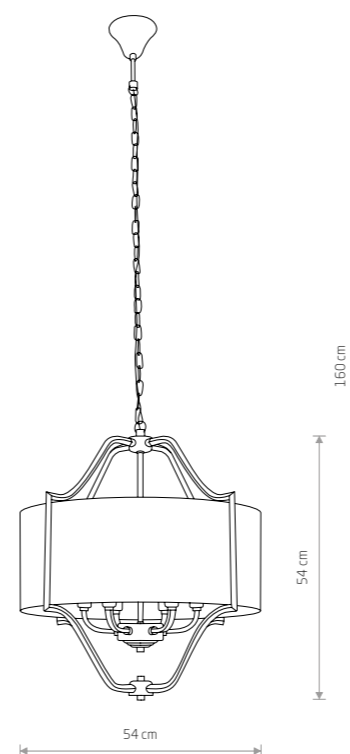

NUNTUCET
chrome plated steel, fabric

8150

6xE14, max 40W

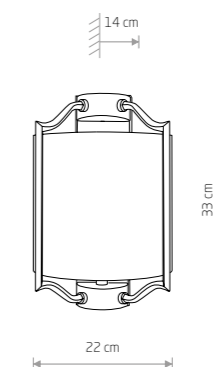

NUNTUCET
chrome plated steel, fabric

8151

1xE14, max 40W

CHROME

WHITE



NEWPORT 8156

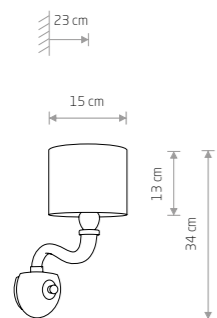

NEWPORT
glass, fabric, chrome plated steel

8157
1xE14, max 40W

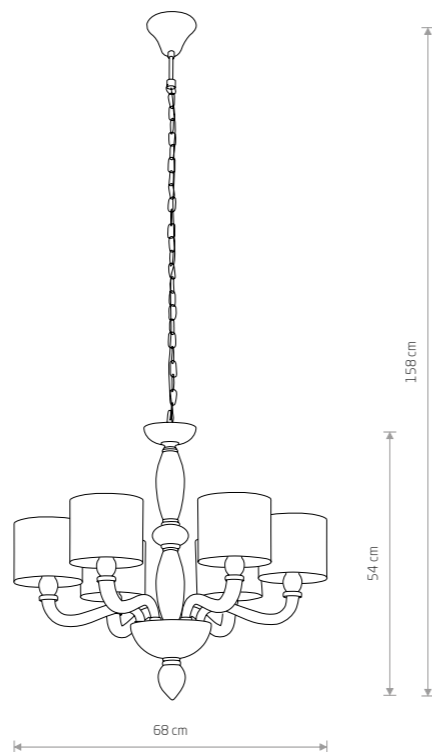

NEWPORT
glass, fabric, chrome plated steel

8156
6xE14, max 40W



TESALLI 4653

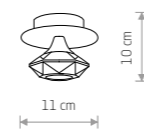

TESALLI
chrome plated steel, glass

4651
1xG9, max 40W

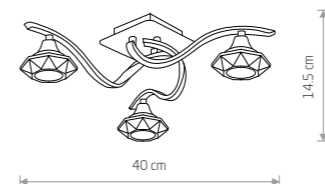

TESALLI
chrome plated steel, glass

4652
3xG9, max 40W

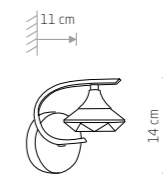

TESALLI
chrome plated steel, glass

4650
1xG9, max 40W

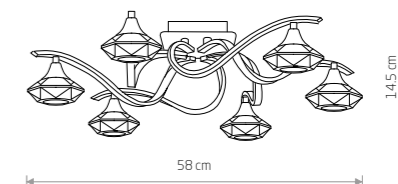

TESALLI
chrome plated steel, glass

4653
6xG9, max 40W

BOSTON 8152



HAMPTON 8155



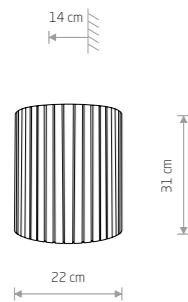

BOSTON
chrome plated steel, glass

8153
1xE14, max 40W

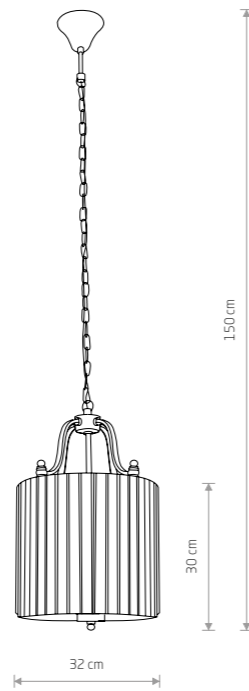

BOSTON
chrome plated steel, glass

8152
4xE14, max 40W

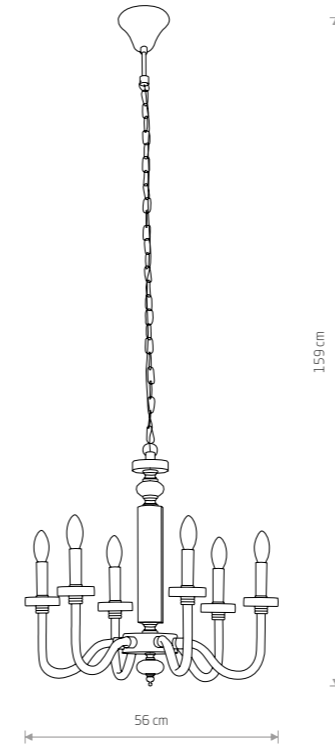

HAMPTON
chrome plated steel, glass

8154
6xE14, max 40W

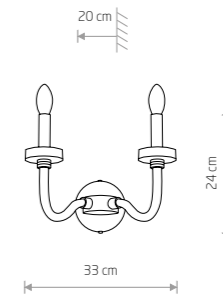

HAMPTON
chrome plated steel, glass

8155
2xE14, max 40W



CRISTAL 7633

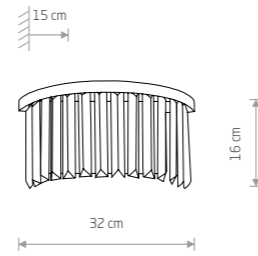

CRISTAL
crystal, painted steel

- 7632 ■ 7633
- 2xE14, max 60W

CRISTAL M 7616

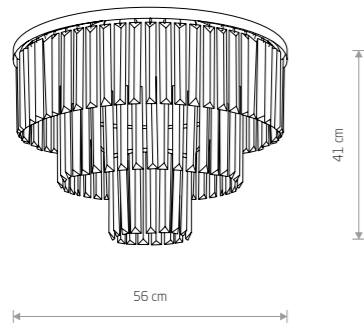

CRISTAL M
crystal, painted steel

- 7628 ■ 7627
- 9xE14, max 60W

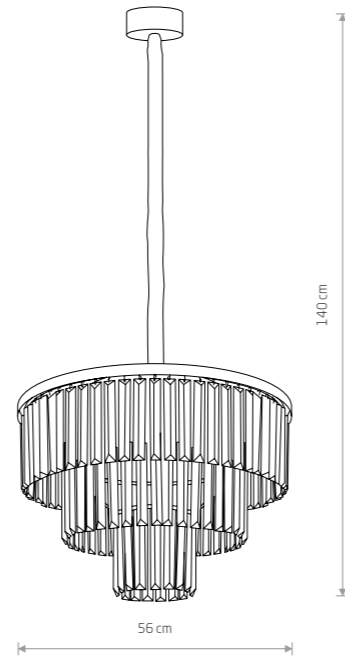

CRISTAL M
crystal, painted steel

- 7617 ■ 7616
- 9xE14, max 40W



CRISTAL L 7631



CRISTAL 7632

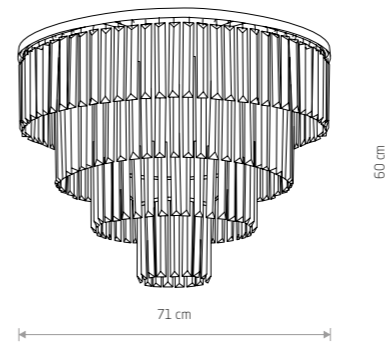

CRISTAL L
crystal, painted steel

- 7631 ■ 7630
- 12xE14, max 60W

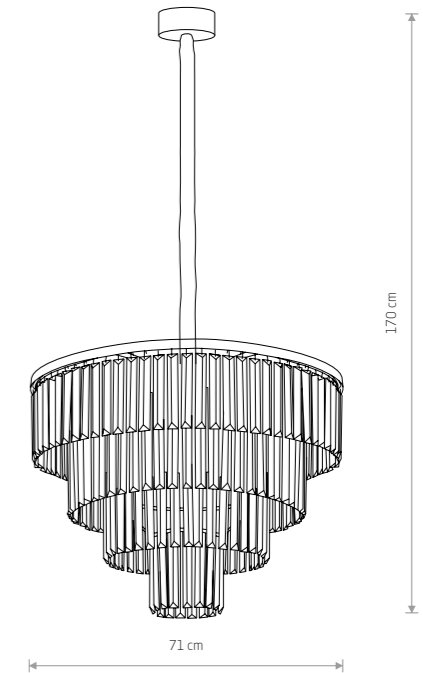

CRISTAL L
crystal, painted steel

- 7615 ■ 7614
- 12xE14, max 40W

KATERINA 5210



KATERINA 5211

MOODENA 4013



MOODENA 4014



KATERINA 5208

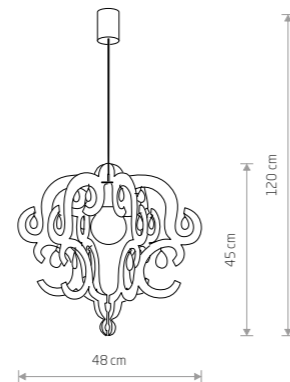

KATERINA
plastic ABS, glass

5208 5210 5211

1xE27, max 60W

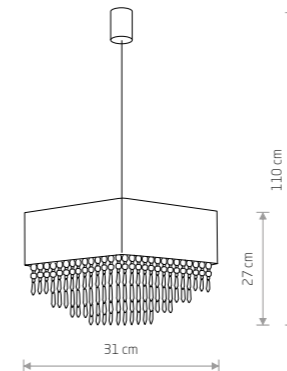

MODENA
fabric, acrylic crystals

4014

1xE27, max 60W

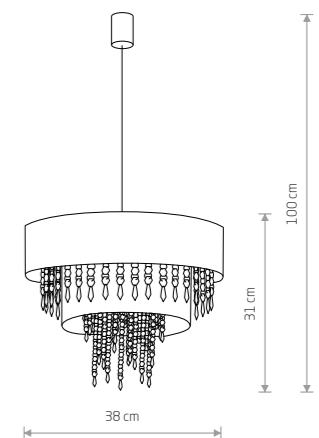

TOSCANA
fabric, acrylic crystals

4013

1xE27, max 60W

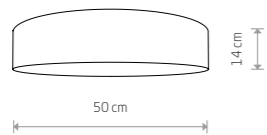

LAGUNA
velvet, plastic, painted steel

8954

3xE27, max 25W only LED

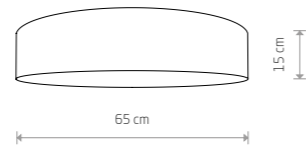

LAGUNA
velvet, plastic, painted steel

8957

4xE27, max 25W only LED

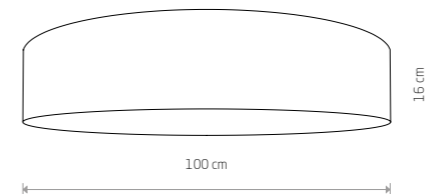

LAGUNA
velvet, plastic, painted steel

8962

9xE27, max 25W only LED

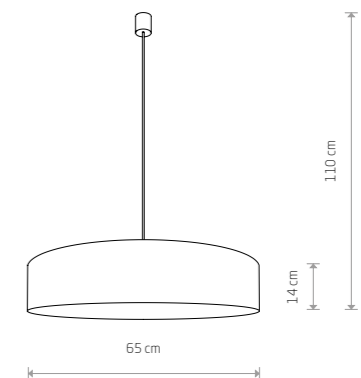

LAGUNA
velvet, plastic, painted steel

8951

3xE27, max 25W only LED



TURDA 8946



TURDA 8947

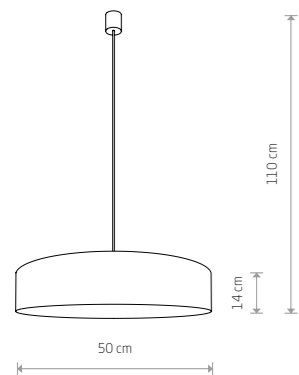

TURDA
fabric, plastic, painted steel

8946

3xE27, max 25W only LED

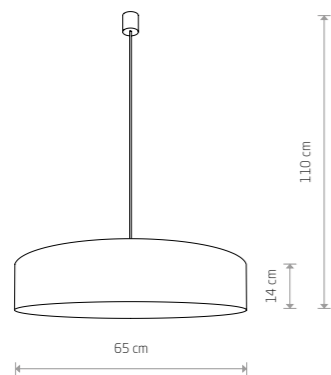

TURDA
fabric, plastic, painted steel

8947

3xE27, max 25W only LED

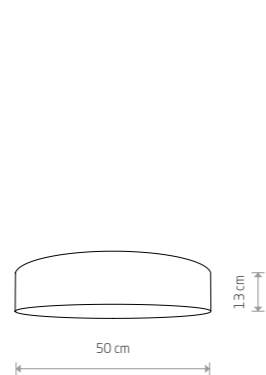

TURDA
fabric, plastic, painted steel

8953

3xE27, max 25W only LED

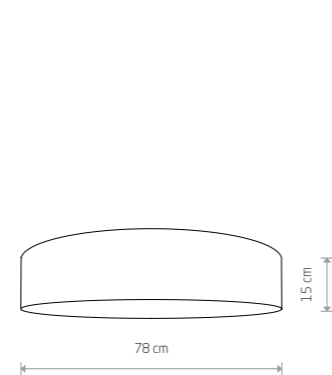

TURDA
fabric, plastic, painted steel

8960

7xE27, max 25W only LED

GRAY T024

WHITE P004 RAL 9003



TURDA 8947



TURDA 8952



TURDA 8958



TURDA 8955



TURDA 8802

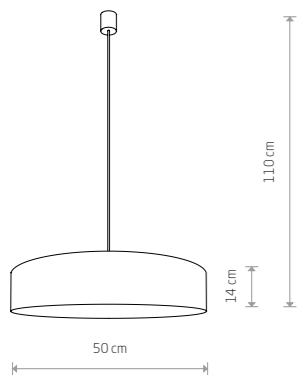

TURDA
fabric, plastic, painted steel

8945
3xE27, max 25W only LED

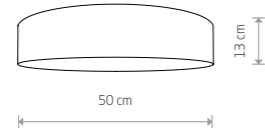

TURDA
fabric, plastic, painted steel

8952
3xE27, max 25W only LED

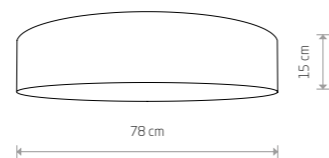

TURDA
fabric, plastic, painted steel

8958
7xE27, max 25W only LED

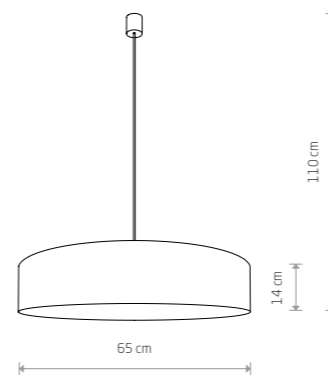

TURDA
fabric, plastic, painted steel

8950
3xE27, max 25W only LED

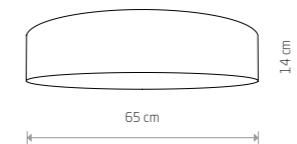

TURDA
fabric, plastic, painted steel

8955
4xE27, max 25W only LED

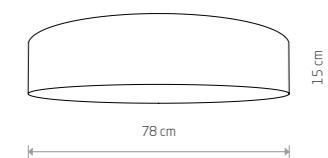

TURDA
fabric, plastic, painted steel

8802
7xE27, max 25W only LED



CROCO 8948



CROCO 8956



CROCO 8961

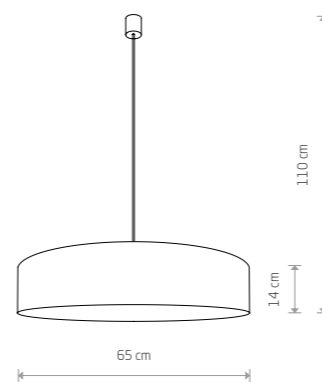

CROCO
velvet, plastic, painted steel

■ 8948

● 3xE27, max 25W only LED

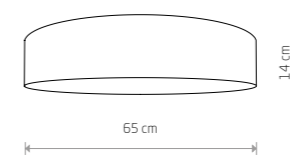

CROCO
velvet, plastic, painted steel

■ 8956

● 4xE27, max 25W only LED

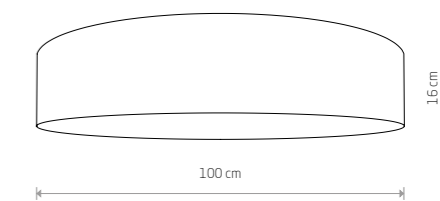

CROCO
velvet, plastic, painted steel

■ 8961

● 9xE27, max 25W only LED



BARREL L 8444



BARREL L 8445

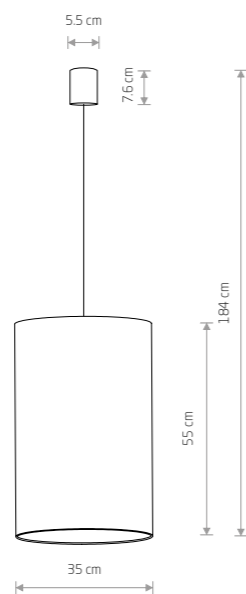

BARREL L
velvet, painted steel

- 8444
- 8445
- 8446

1xE27, max 60W



CONE M 8442



CONE L 8437



CONE L 8440

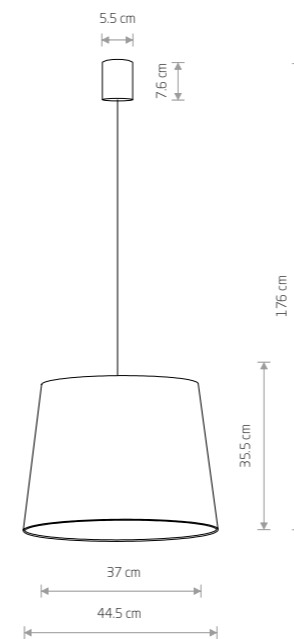

CONE M
velvet, painted steel

- 8441
- 8443
- 8442

1xE27, max 60W

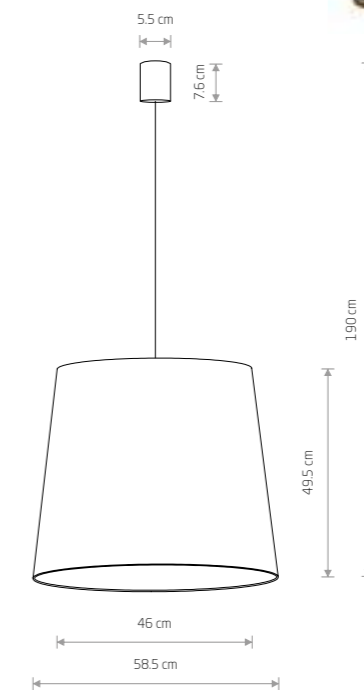

CONE L
velvet, painted steel

- 8437
- 8440
- 8438

1xE27, max 60W

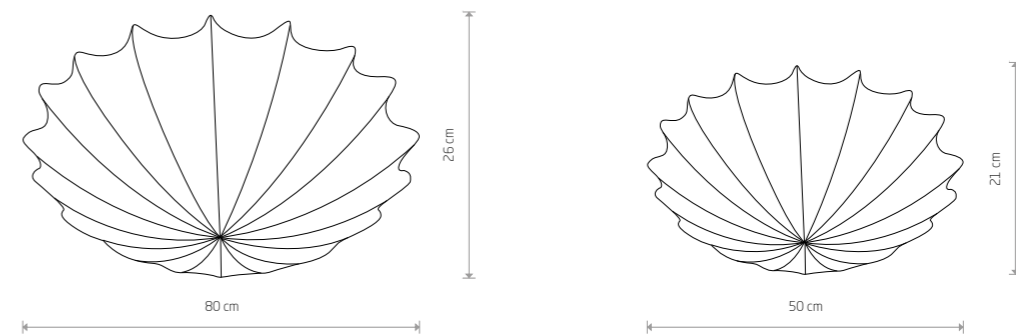
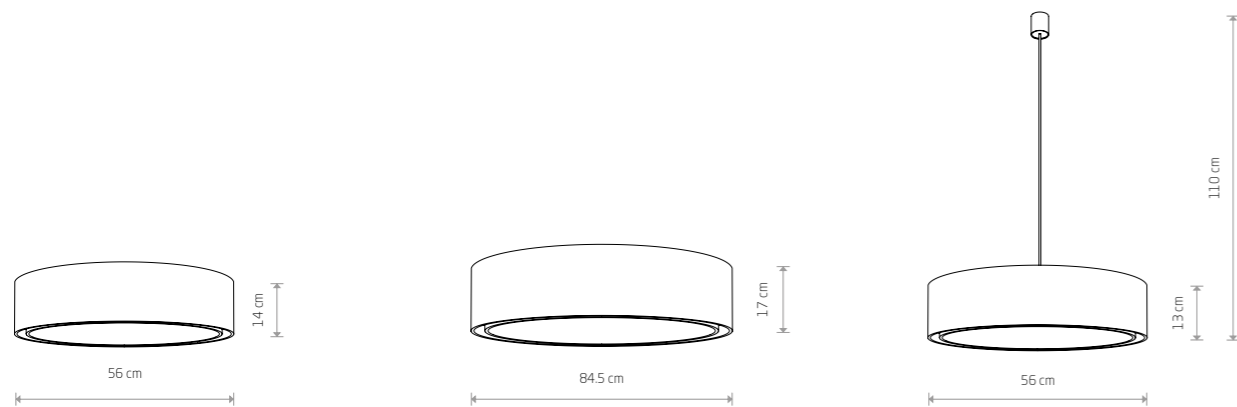
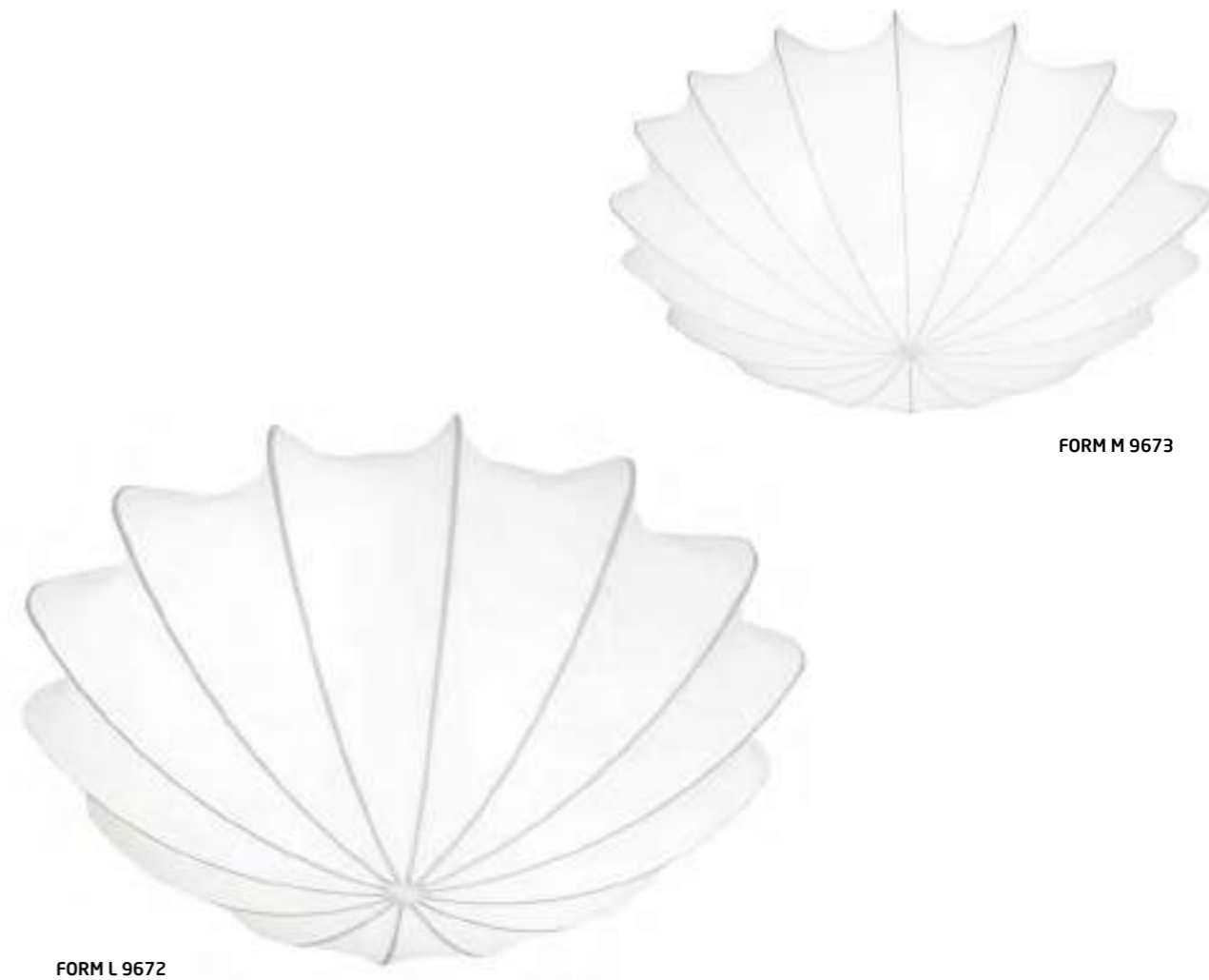

MIST
fabric, plastic, painted steel

- 8943
- 3xE27, max 25W only LED

MIST
fabric, plastic, painted steel

- 8944
- 7xE27, max 25W only LED

MIST
fabric, plastic, painted steel

- 8942
- 3xE27, max 25W only LED

FORM L
fabric, painted steel

- 9672
- 4xE27, max 25W only LED

FORM M
fabric, painted steel

- 9673
- 2xE27, max 25W only LED



CAMERON 9606



CAMERON 9685



CAMERON 9682



CAMERON 9683

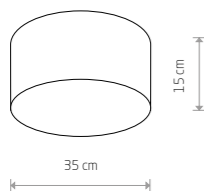

CAMERON
fabric, plastic, painted steel

9605
2xE27, max 25W only LED

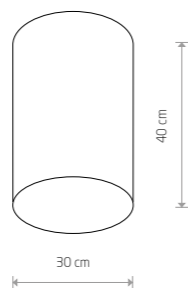

CAMERON
fabric, plastic, painted steel

9685
1xE27, max 25W only LED

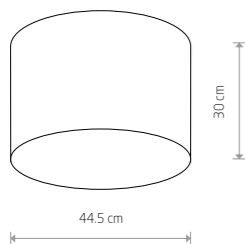

CAMERON
fabric, plastic, painted steel

9684
3xE27, max 25W only LED

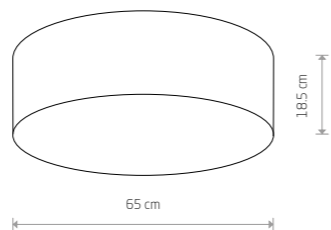

CAMERON
fabric, plastic, painted steel

9606
4xE27, max 25W only LED

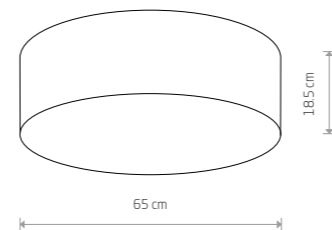

CAMERON
fabric, plastic, painted steel

9682
4xE27, max 25W only LED

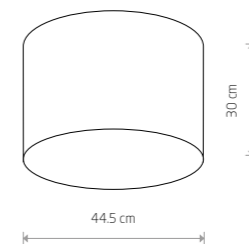

CAMERON
fabric, plastic, painted steel

9683
3xE27, max 25W only LED

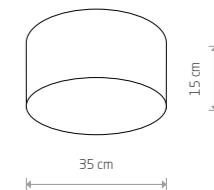

CAMERON
fabric, plastic, painted steel

9687
2xE27, max 25W only LED



VIVIANE 6772



VIVIANE 6773



VIOLET 7958



VIOLET 7960



VIVIANE 6390



VIOLET 7961

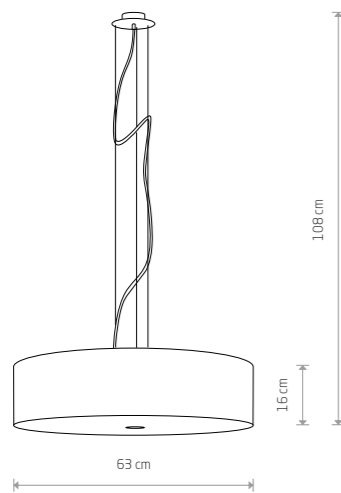

VIVIANE
fabric, glass, chrome

6772 6773 6774

3xE27, max 60W

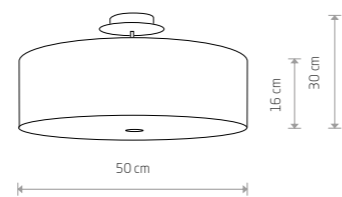

VIVIANE
fabric, glass, chrome

6391 6532 6390

3xE27, max 60W

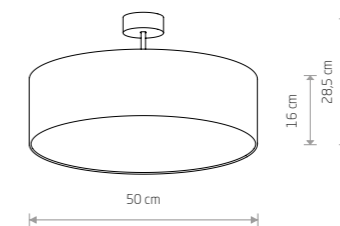

VIOLET
fabric, plastic, painted steel

7958 7960 7961

3xE27, max 25W only LED



FALCON 7950



HAWK 8843

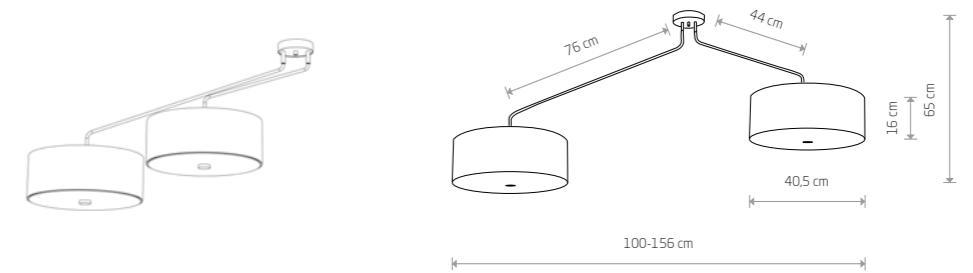
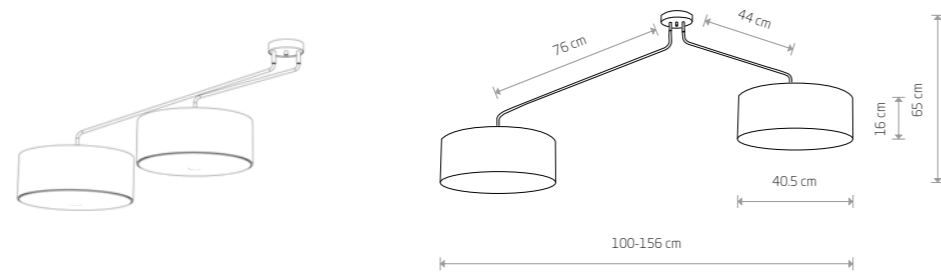

FALCON

fabric, plastic, painted steel

- 7951
- 7948
- 7950

6xE27, max 25W only LED

HAWK

fabric, glass, painted steel

- 8843
- 6541

6xE27, max 60W

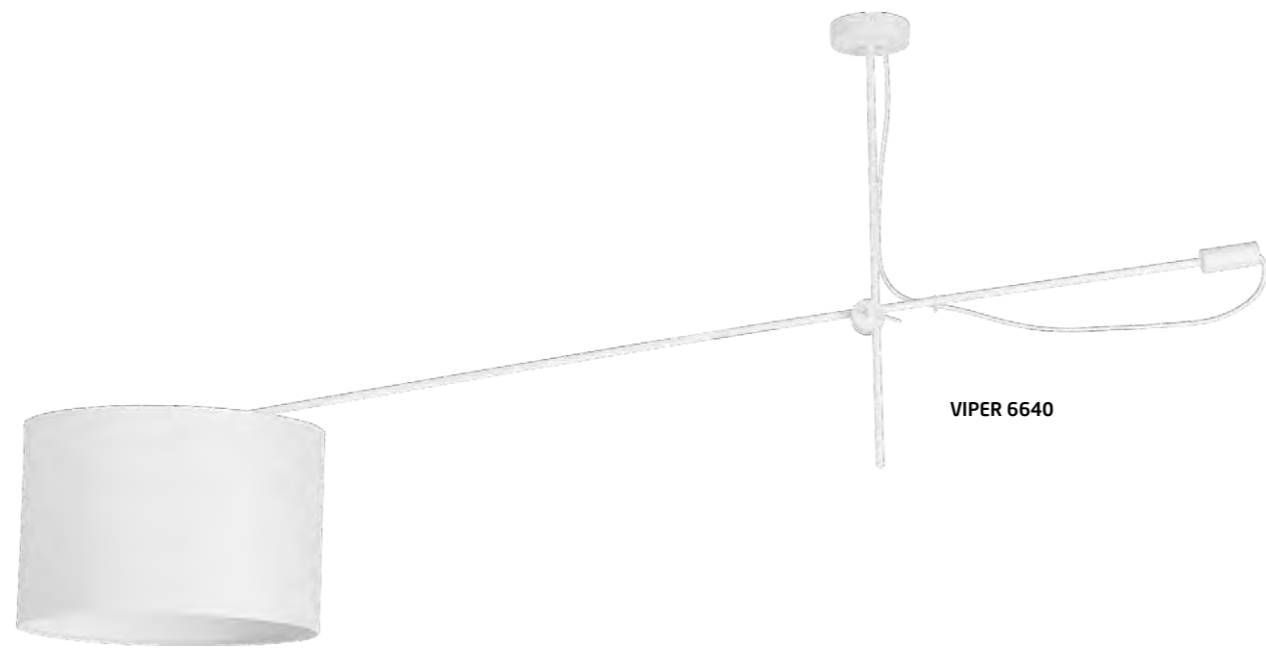

VIPER 6640

VIPER

fabric, painted steel

6640 6641

1xE27, max 60W

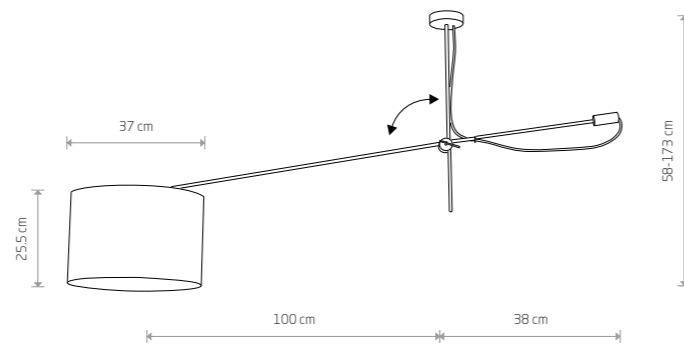

VIPER 6513

VIPER

fabric, painted steel, chrome

6512 6513

1xE14, max 40W

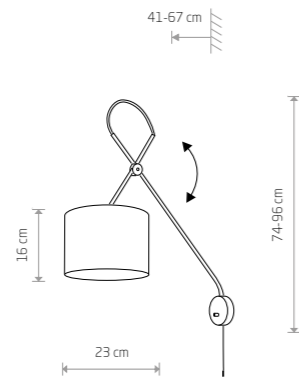

VIPER 6513

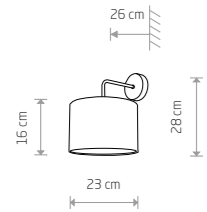

ALICE
fabric, painted steel
9084
1xE27, max 60W

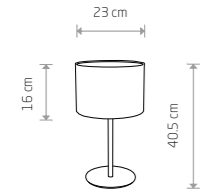

ALICE
fabric, painted steel
9091
1xE27, max 60W

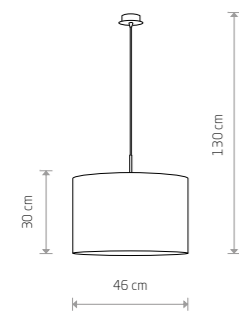

ALICE L
fabric, painted steel
4961
1xE27, max 60W

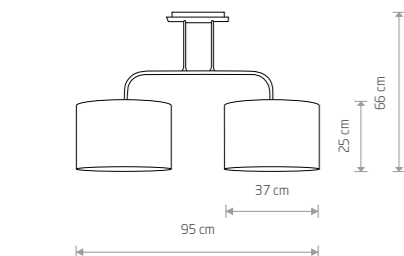

ALICE M
fabric, painted steel
4962
2xE27, max 60W

ALICE 9091

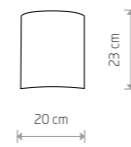

ALICE XS
fabric, painted steel
5663
1xE27, max 60W

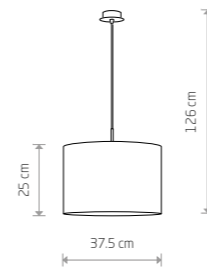

ALICE M
fabric, painted steel
3458
1xE27, max 60W

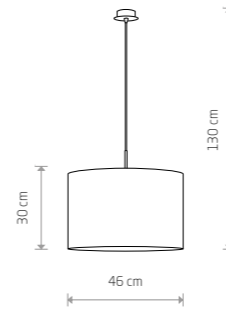

ALICE L
fabric, painted steel
3466
1xE27, max 60W

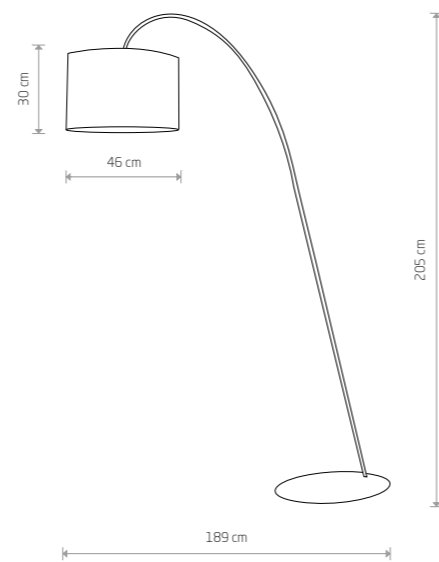

ALICE L
painted steel, fabric
4963
1xE27, max 60W

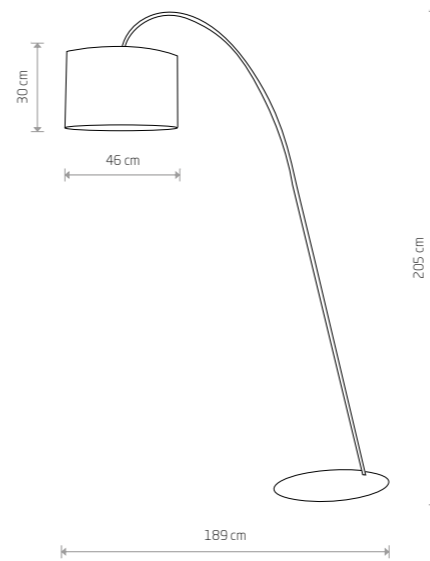

ALICE L
painted steel, fabric
3464 3457
1xE27, max 60W



ALICE L 3466



ALICE XS 5663



ALICE M 6815

ALICE M 6817

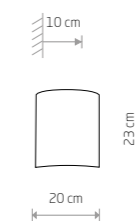

ALICE XS
fabric, painted steel

6812 5723
1xE27, max 60W

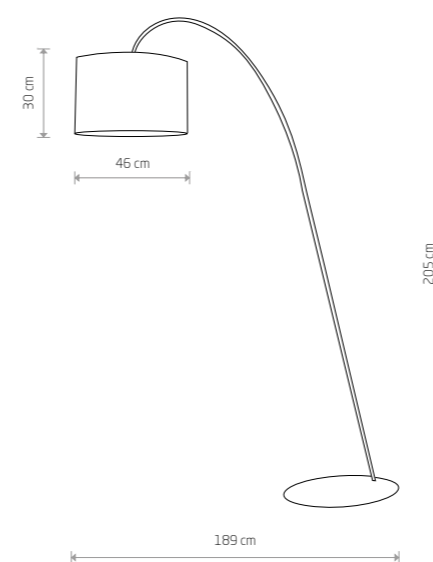

ALICE L
painted steel, fabric

6818 5386
1xE27, max 60W

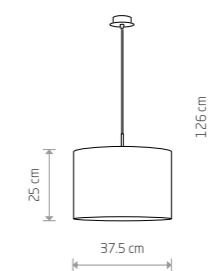

ALICE M
fabric, painted steel

6815 5383
1xE27, max 60W

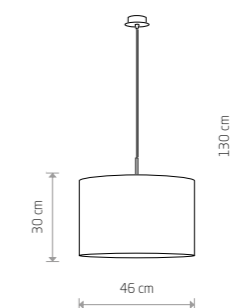

ALICE L
fabric, painted steel

6816 5384
1xE27, max 60W

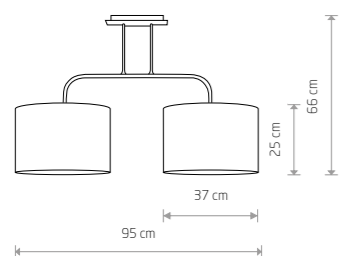

ALICE M
fabric, painted steel

6817
2xE27, max 60W

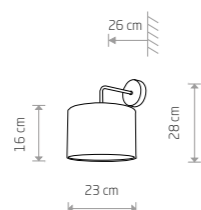

ALICE
fabric, painted steel

9083
1xE27, max 60W

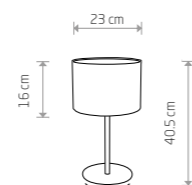

ALICE
fabric, painted steel

9090
1xE27, max 60W



FLEX SHADE 9277

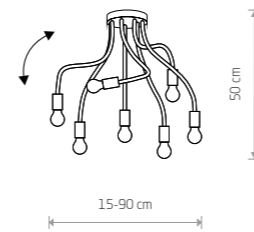

FLEX
flexible stem, painted steel

9274 ■ 9273
7xE27, max 60W



FLEX 9273

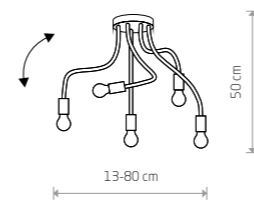

FLEX
flexible stem, painted steel

9772 ■ 9766
5xE27, max 60W

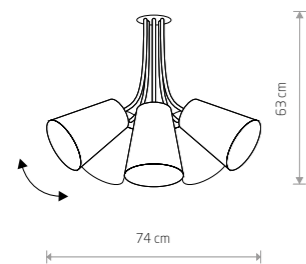

FLEX SHADE
fabric, flexible stem, painted steel

9277 ■ 9278
5xE27, max 60W

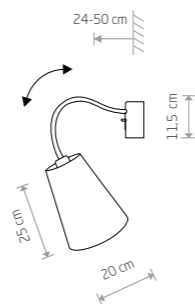

FLEX SHADE
fabric, flexible stem, painted steel

9764 ■ 9758
1xE27, max 60W

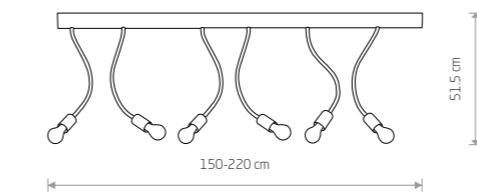

FLEX
flexible stem, painted steel

9765
6xE27, max 60W

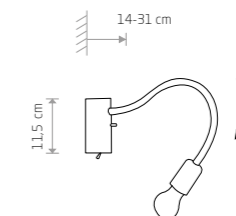

FLEX
flexible stem, painted steel

9774 ■ 9768
1xE27, max 60W

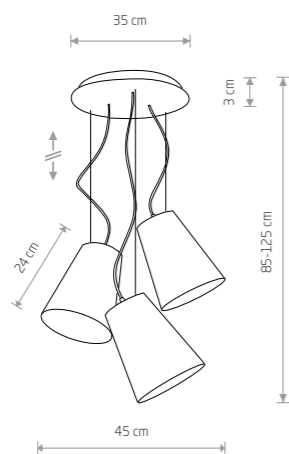

RETTO
fabric, painted steel

6820
3xE27, max 60W



MOSS
fabric, plywood, painted steel

9736
3xE27, max 60W

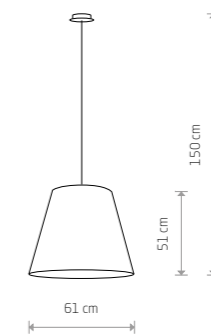

MOSS
fabric, painted steel

9737
3xE27, max 60W

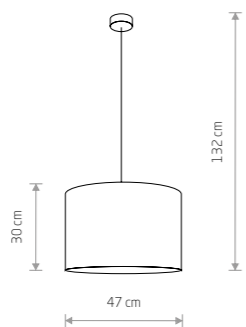

HOTEL
fabric, chrome plated steel

9298
1xE27, max 60W



HOTEL LED 9302

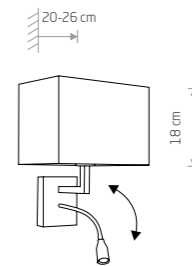

HOTEL LED
fabric, chrome plated steel

6800 9302
1xE27 max 60W, 1x2.2W LED



HOTEL 9218

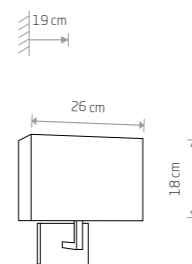

HOTEL
fabric, chrome plated steel

4730 9218
1xE27, max 60W



HOTEL 9304

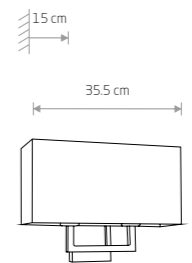

HOTEL
fabric, chrome plated steel

4731 9304
2xE27, max 60W



HOTEL 9301

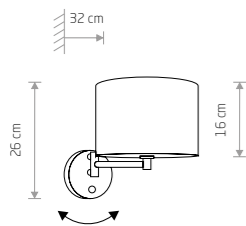

HOTEL 9303

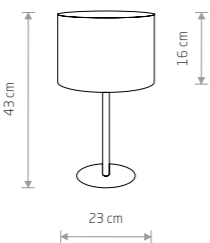

HOTEL
chrome plated steel, fabric

8982 9301

1xE27, max 60W

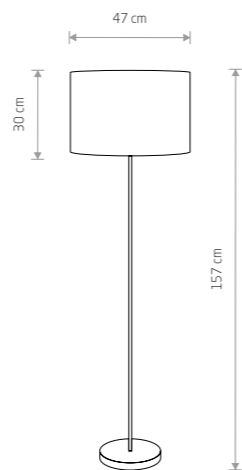

HOTEL
fabric, chrome plated steel

8981 9300

1xE27, max 60W



HOTEL PLUS 9073

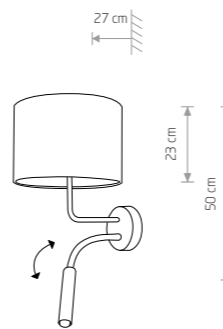

HOTEL PLUS
fabric, painted steel, flexible stem

9073 9071

1xE27 max 60W, 1xG9 max 20W only LED

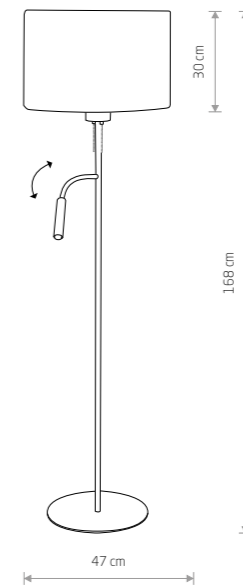

HOTEL PLUS 9072

HOTEL PLUS
fabric, painted steel, flexible stem

9074 9072

1xE27 max 60W, 1xG9 max 20W only LED



HOTEL
fabric, chrome plated steel

9303 8980

1xE14, max 60W



CHILLIN 8216



CHILLIN 8215



CHILLIN 8201



CHILLIN 8200



CHILLIN 8211



CHILLIN 8214



CHILLIN 8213



CHILLIN 8197



CHILLIN 8198

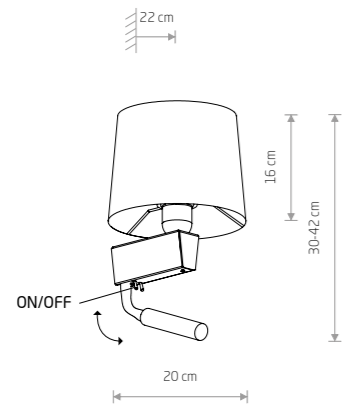

CHILLIN

fabric, painted steel, flexible stem

- 8216
- 8215

1xE27 max 40W, 1xG9 max 10W only LED

fabric, painted steel, solid brass, flexible stem

- 8213

1xE27 max 40W, 1xG9 max 10W only LED

velvet, painted steel, solid brass, flexible stem

- 8214

1xE27 max 40W, 1xG9 max 10W only LED

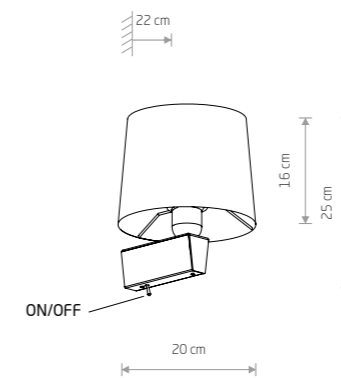

CHILLIN

fabric, painted steel

- 8201
- 8200
- 8197

1xE27, max 40W

fabric, brushed stainless steel

- 8211

1xE27, max 40W

velvet, painted steel

- 8198

1xE27, max 40W



BORDE 7985



BORDE 7985



BORDE 7987



BORDE 7986



BORDE 8044



BORDE 8046

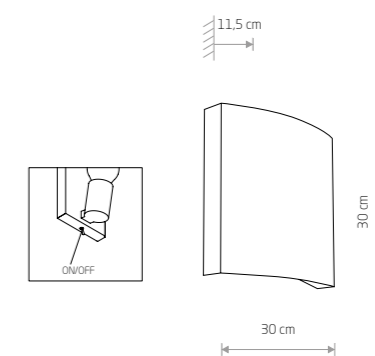
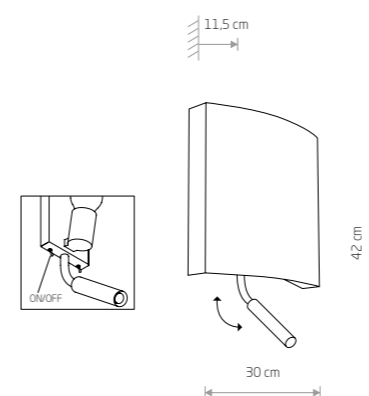

BORDE 8045

**BORDE**

fabric, painted steel, flexible stem

7985 7987

1xE27 max 40W, 1xG9 max 10W only LED

fabric, solid brass, flexible stem

7986

1xE27 max 40W, 1xG9 max 10W only LED

BORDE

fabric

8044 8045 8046

1xE27, max 40W

VELERO 7984



VELERO 8043

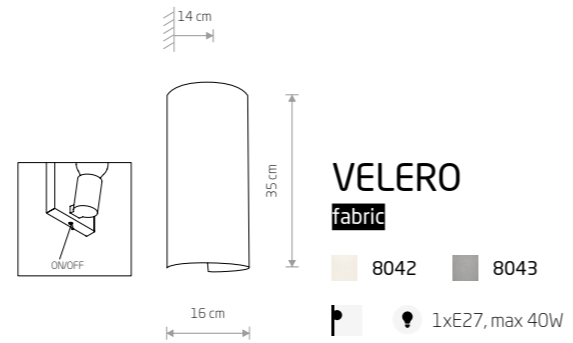

FARO 7982



FARO 8041



VELERO 7984



PETIT A 8340

PETIT 8345

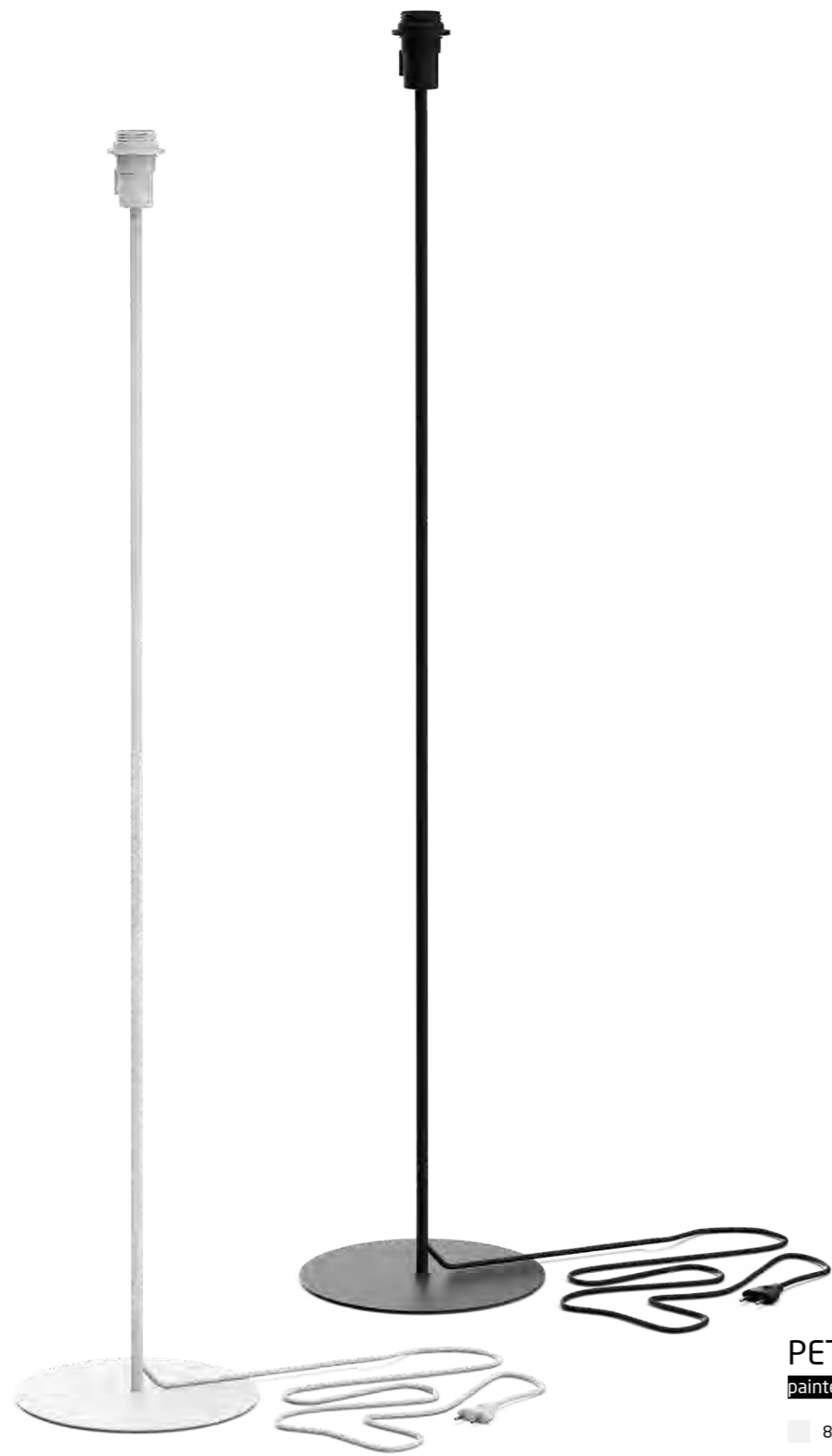

PETIT
 painted aluminum, painted steel

8345 8346

1xE27, max 40W

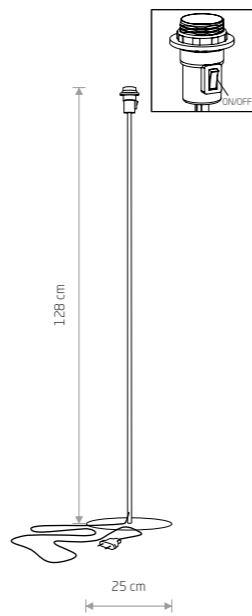

PETIT A

fabric, painted steel

8333 8337 8343 8332

velvet, painted steel

8340 8344 8334



PETIT B

fabric, painted steel

8338 8336 8342



PETIT C

fabric, painted steel

8226 8335 8341

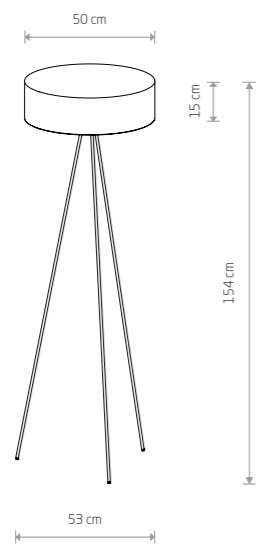

CADILAC

fabric, painted steel, plastic

7988 7990 8190

3xE27, max 25W only LED

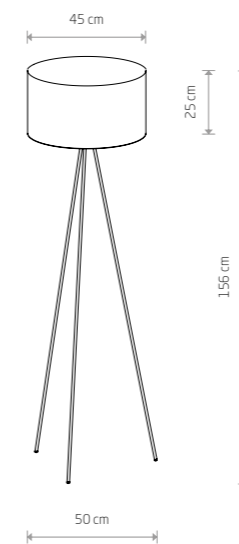

CADILAC

fabric, painted steel

7992 7991 8191

1xE27, max 40W



TRIFLE 7760



7758 7760 7761 8077



8078 8080 8076 8075

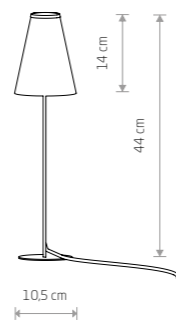

TRIFLE

fabric, painted aluminum

- 7758
- 7760
- 7761
- 8076
- 8077
- 8078
- 8080
- 8075

1xG9, max 10W only LED

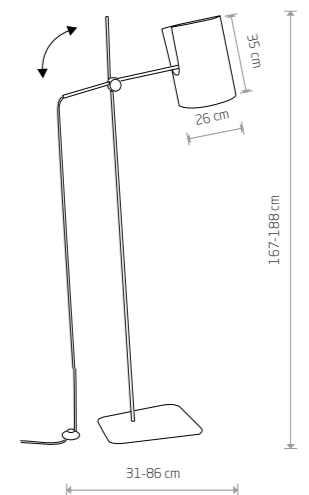
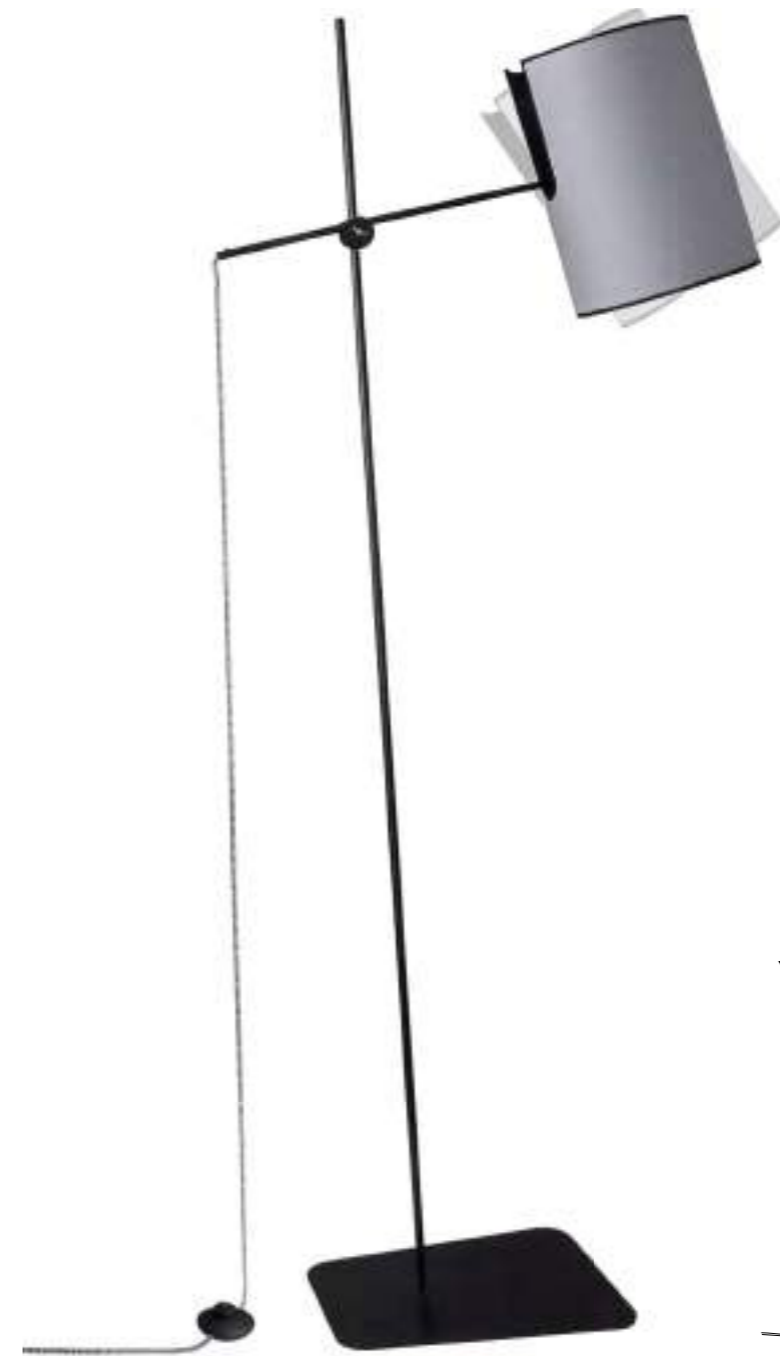

ZELDA

fabric, painted steel

6010

1xE27, max 60W

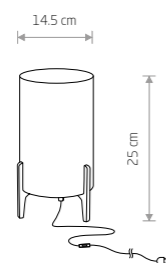

ROCKET

fabric, plywood

8490 8448

1xE27, max 40W

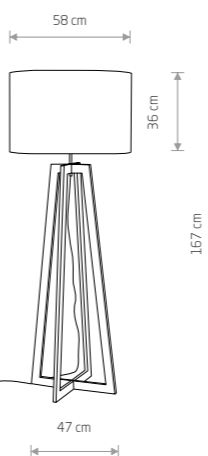

ACROSS

plywood, fabric, braided cable

6927

1xE27, max 60W

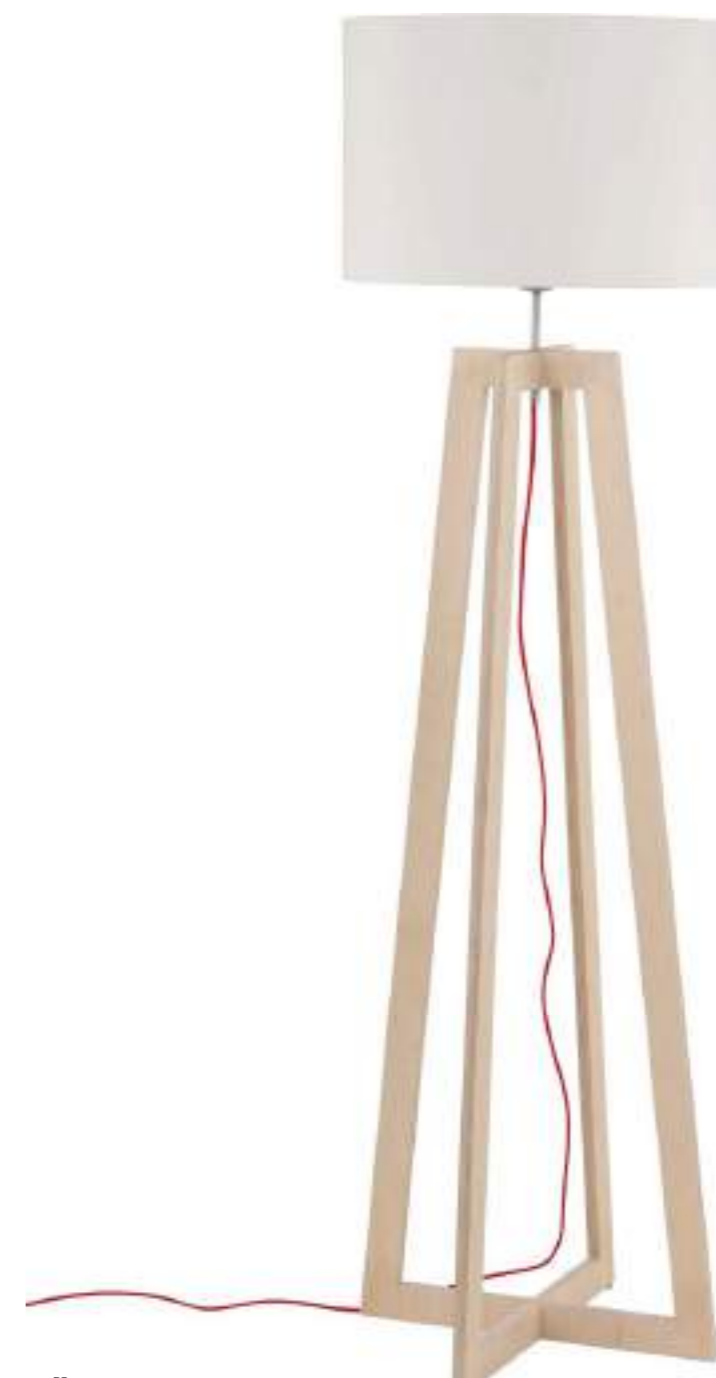



SUNSET B 7655



SUNSET A 7653



SUNSET C 7654



SUNRISE LED 7652

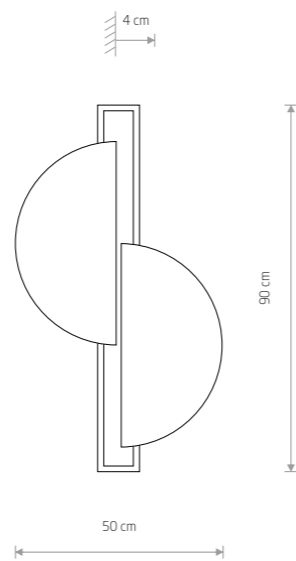

SUNRISE LED

plywood, painted steel

7652

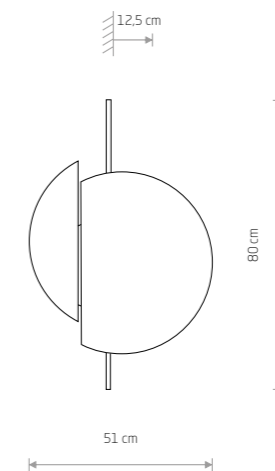

SUNSET C

plywood, painted steel

7654

2xGX53, max 8W

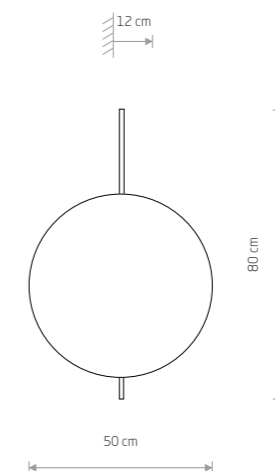

SUNSET B

plywood, painted steel

7655

2xGX53, max 8W

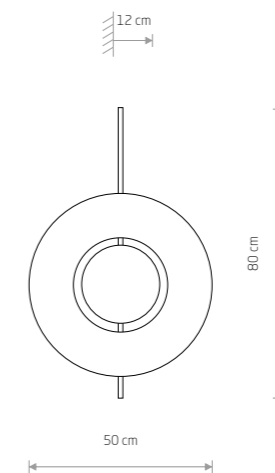

SUNSET A

plywood, painted steel

7653

2xGX53, max 8W



Item No.	Power	Colour temp.	Luminous flux	Beam angle	Colour Rendering Index (CRI)	Input	Safety type	Ingress protection	Lifetime
7652	12W LED	3000K	520 lm	150°	80	220-230 V, 50/60 Hz	⊕	IP20	50000h

DARK WOOD BLACK P013 RAL 9005

DARK WOOD BLACK P013 RAL 9005



SUN LED 7651

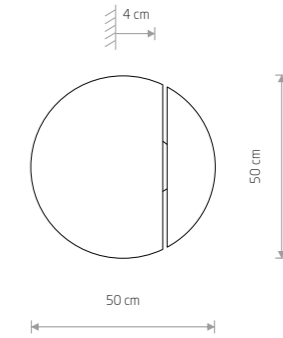

SUN LED
plywood, painted steel

7651

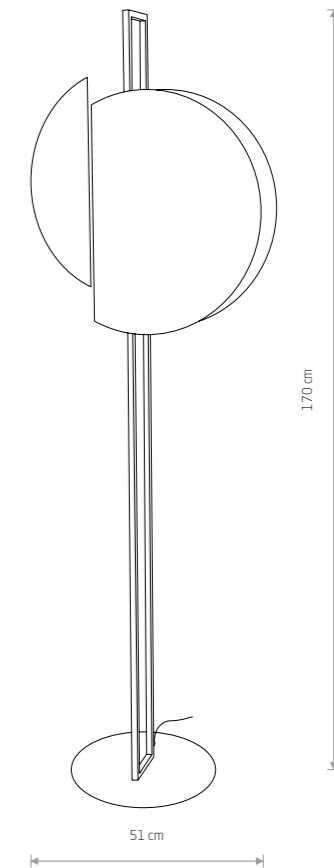

SUNSET
plywood, painted steel

7647



2xGX53, max 8W

Item No.	Power	Colour temp.	Luminous flux	Beam angle	Colour Rendering Index (CRI)	Input	Safety type	Ingress protection	Lifetime
7651	15W LED	3000K	610 lm	150°	80	220-230 V, 50/60 Hz	⊕	IP20	50000h

DARK WOOD BLACK P013 RAL 9005 GOLD



WHEEL 9028

WHEEL 9033

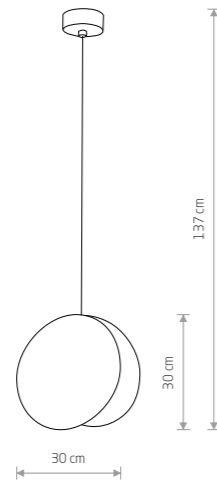

WHEEL
plywood, painted steel

9028 9033

1xE27, max 40W

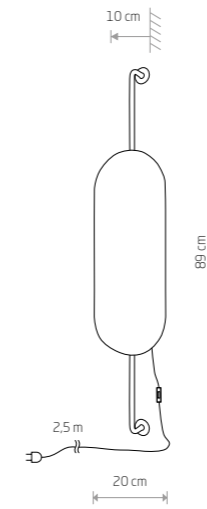

WHEEL LUX
plywood, painted steel

8427 8428

2xG9, max 20W

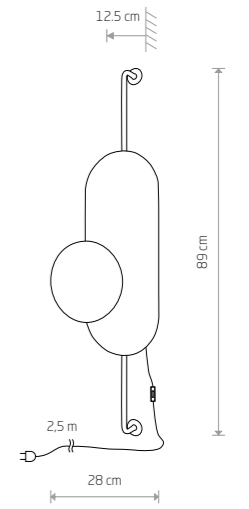

WHEEL LUX
plywood, painted steel

8430

1xG9, max 20W

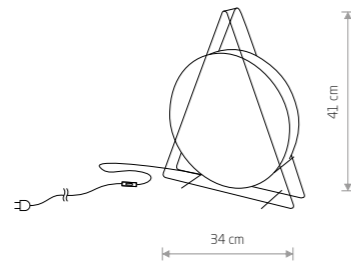

WHEEL
plywood, painted steel

9032

1xG9, max 20W

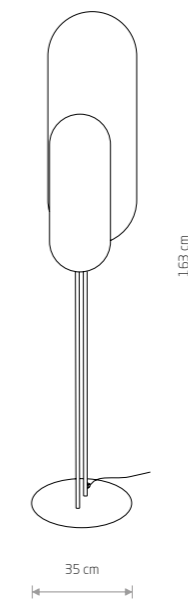

WHEEL LUX
plywood, plywood, steel

7646

2xGX53, max 8W



MINIMAL 9375

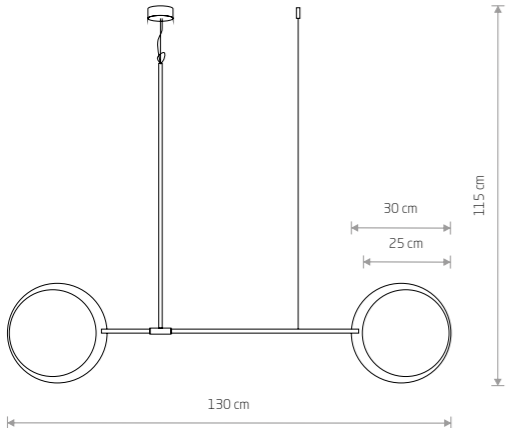

MINIMAL
wood, painted steel, solid brass

- 9375
- 2xE27, max 40W

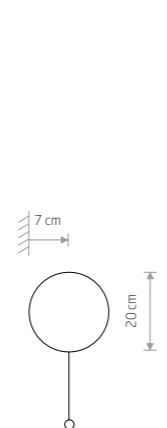

MINIMAL
wood, painted steel

- 9377
- 1xG9, max 10W



DISK 7644

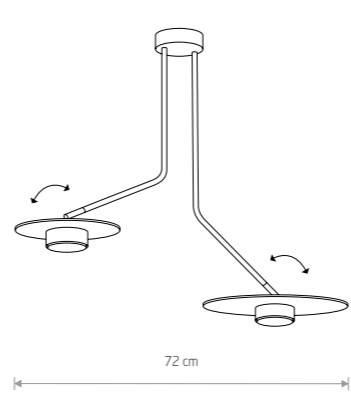

DISK
painted steel, plywood

- 7643
- 2xGX53, max 8W

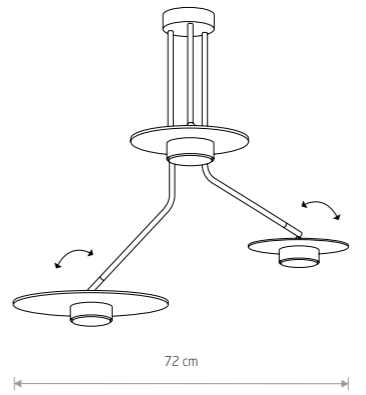

DISK
painted steel, plywood

- 7644
- 3xGX53, max 8W

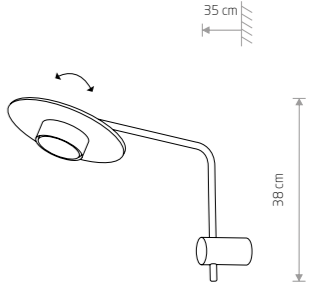

DISK
painted steel, plywood

- 7645
- 1xGX53, max 8W



OSLO LED 7522

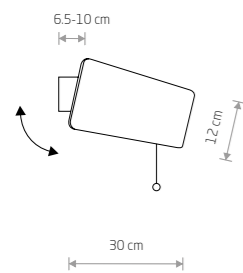

OSLO 30
wood, painted steel

9700
1xE14, max 40W

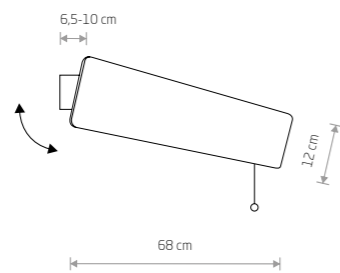

OSLO LED 60
wood, painted steel

7521 7517
1xLED TUBE T8, max 11W, included

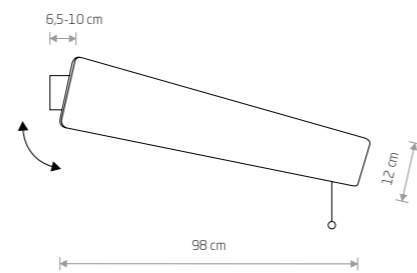

OSLO LED 90
wood, painted steel

7518
1xLED TUBE T8, max 16W, included

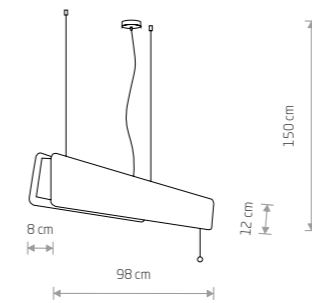

OSLO LED 90
wood, painted steel

7522 7520
1xLED TUBE T8, max 16W, included

Name	Size	Power	Colour temp.	Luminous flux	Beam angle	Colour Rendering Index (CRI)	Input	Power factor	LED driver	Lifetime	Material
LED TUBE T8	60 cm	11W LED	3000K	1700 lm	120 °	≥80	220-230 V, 50/60 Hz	>0,5	INCL	30000h	CLEAR GLASS
LED TUBE T8	90 cm	16W LED	3000K	2300 lm	120 °	≥80	220-230 V, 50/60 Hz	>0,5	INCL	30000h	CLEAR GLASS

OAK SMOKED OAK WHITE P004 RAL 9003

OAK SMOKED OAK WHITE P004 RAL 9003

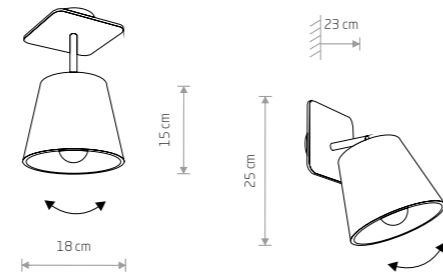

AWINION

fabric, plywood, painted steel

■ 9718

☐ ☑ ⚡ 1xE27, max 40W

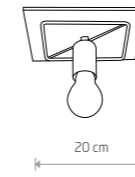

COBA ANTIQUE

plywood, painted steel

■ 9042

☐ ☑ ⚡ 1xE27, max 60W

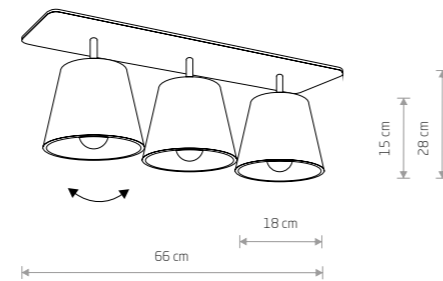

AWINION

fabric, plywood, painted steel

■ 9717

☐ ☑ ☑ ⚡ 3xE27, max 40W

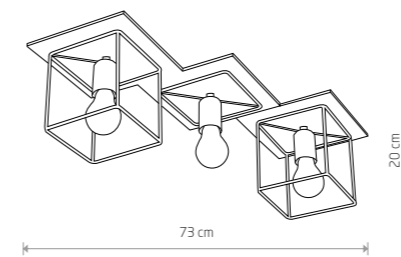

COBA ANTIQUE

plywood, painted steel

■ 9043

☐ ☑ ☑ ⚡ 3xE27, max 60W

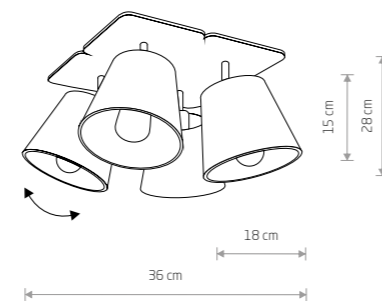

AWINION

fabric, plywood, painted steel

■ 9716

☐ ☑ ☑ ☑ ⚡ 4xE27, max 40W

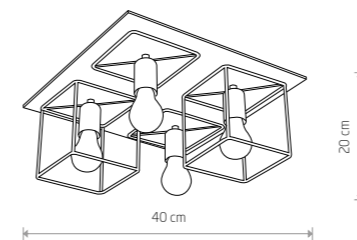

COBA ANTIQUE

plywood, painted steel

■ 9044

☐ ☑ ☑ ☑ ⚡ 4xE27, max 60W



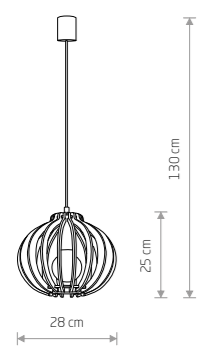

IKA C

plywood, painted steel

4173

1xE27, max 60W

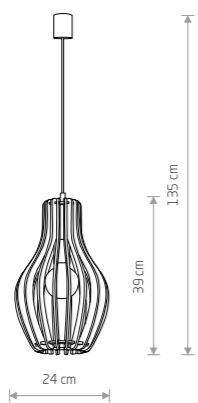

IKA A

plywood, painted steel

4171

1xE27, max 60W

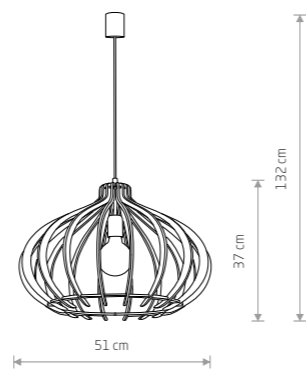

IKA D

plywood, painted steel

4174

1xE27, max 60W



BIO 6333

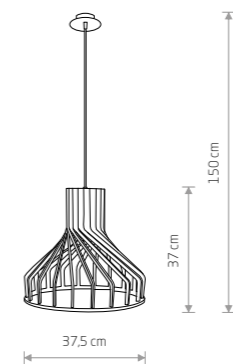

BIO

plywood

6333

1xGU10, max 35W

plywood

9847

1xE27, max 40W



DOVER 9263

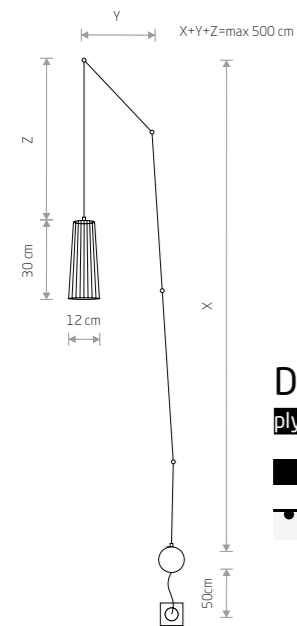

DOVER

plywood, braided cable, painted steel

■ 9264

🔌 1xGU10, max 35W

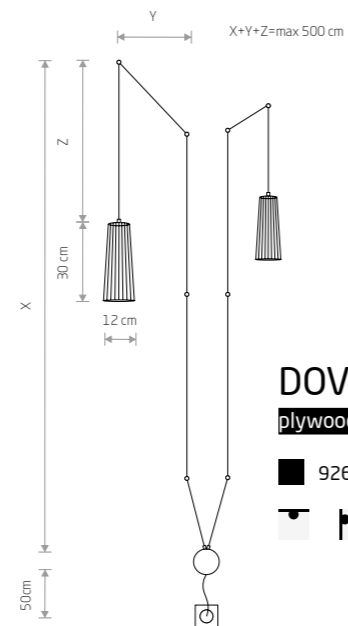

DOVER

plywood, braided cable, painted steel

■ 9263

🔌 2xGU10, max 35W



DOVER 9260

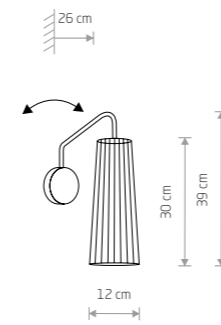

DOVER

plywood, painted steel

■ 9261

🔌 1xGU10, max 35W

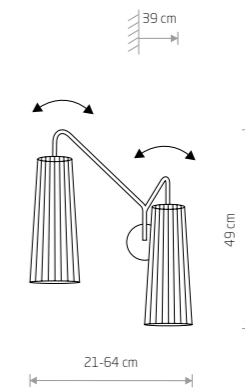

DOVER

plywood, painted steel

■ 9260

🔌 2xGU10, max 35W



ORBIT 7804



ORBIT 7805



ORBIT 7806



ORBIT 7946





ORBIT 7806

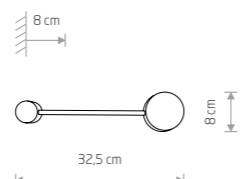

ORBIT

painting steel

7803 7806

1xGX53, max 8W



ORBIT 7805

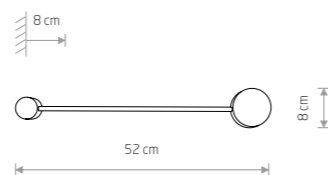

ORBIT

painting steel

7802 7805

1xGX53, max 8W

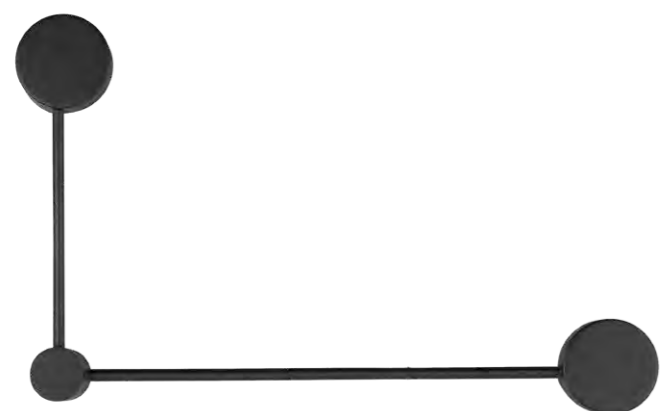

ORBIT 7804

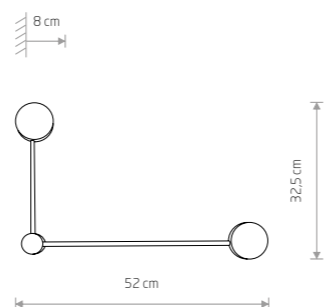

ORBIT

painting steel

7801 7804

2xGX53, max 8W

ORBIT

painting steel

7938 7943

2xGX53, max 8W

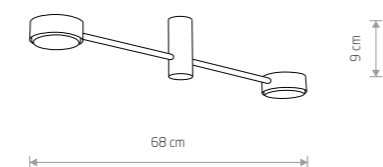

ORBIT 7946

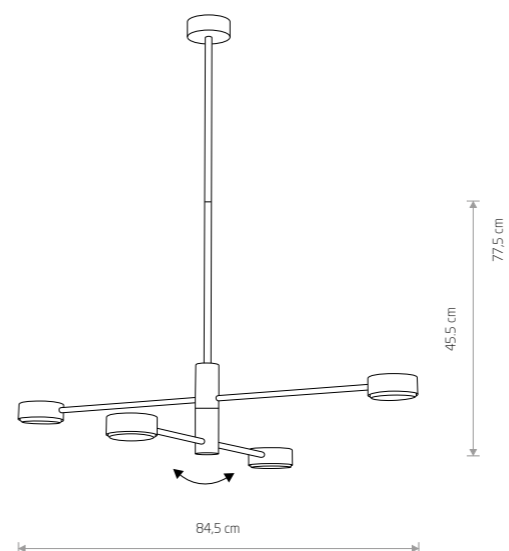

ORBIT

painting steel

7941 7945

4xGX53, max 8W

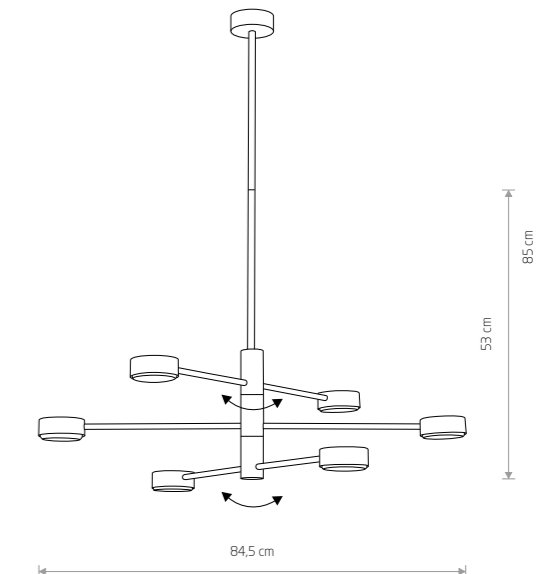

ORBIT

painting steel

7942 7946

6xGX53, max 8W



PILLS 8265

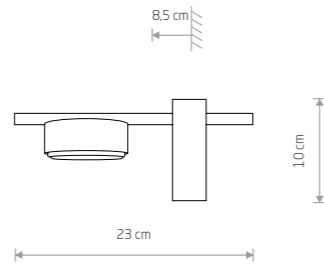

PILLS
painted aluminum, painted steel

8271 8265

1xGX53, max 8W

PILLS 8263

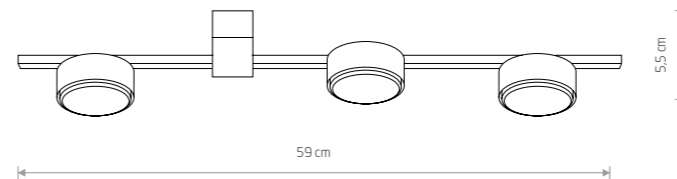

PILLS
painted aluminum, painted steel

8268 8263

3xGX53, max 8W



PILLS 8266

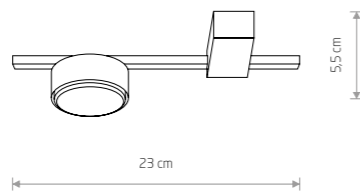

PILLS
painted aluminum, painted steel

8272 8266

1xGX53, max 8W

PILLS 8262

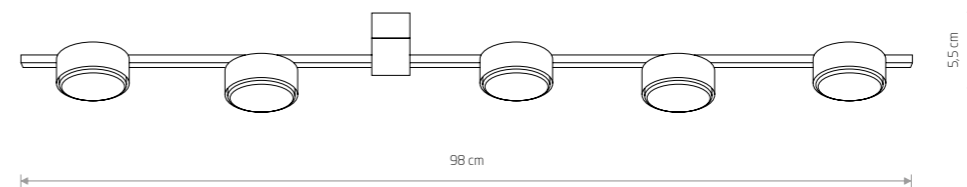

PILLS
painted aluminum, painted steel

8267 8262

5xGX53, max 8W



PILLS 8264

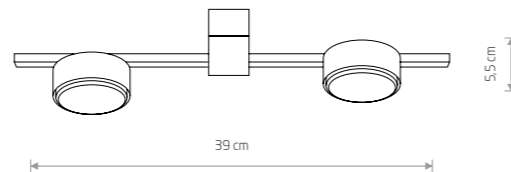

PILLS
painted aluminum, painted steel

8270 8264

2xGX53, max 8W

PILLS
painted aluminum, painted steel

8267 8262

5xGX53, max 8W

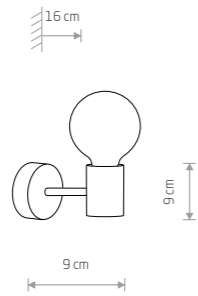

RADIUS
painted steel

■ 7930

🔌 1xE27, max 60W

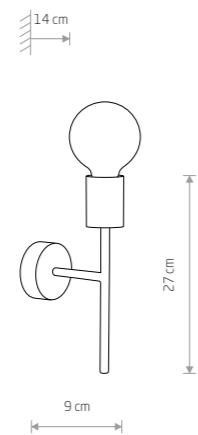

RADIUS
painted steel

■ 7762

🔌 1xE27, max 60W

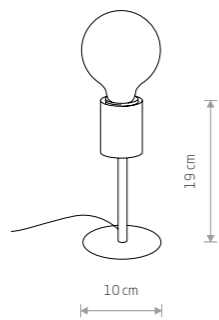

RADIUS
painted steel

■ 7928

🔌 1xE27, max 60W



RADIUS 7932

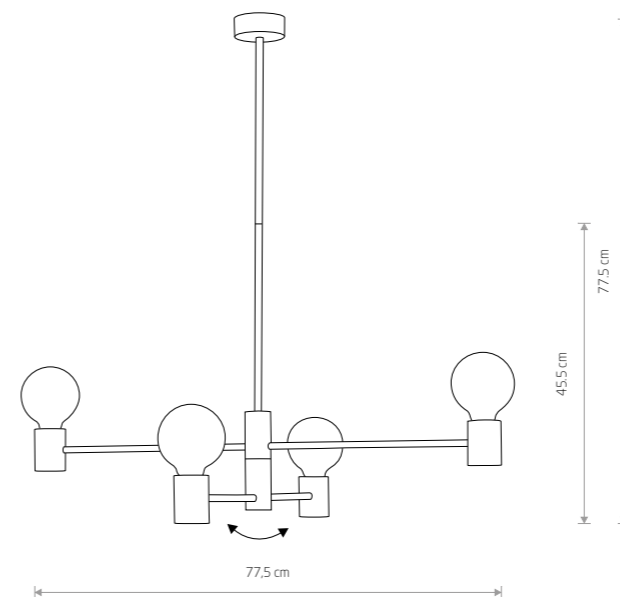

RADIUS
painted steel

■ 7931

🔌 4xE27, max 60W

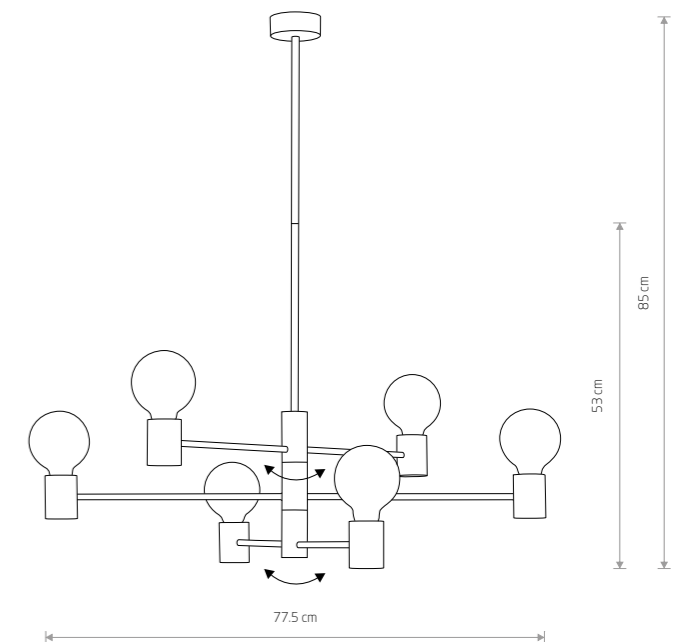

RADIUS
painted steel

■ 7932

🔌 6xE27, max 60W



ROTOR 7937

ROTOR 7933



ROTOR 7934



ROTOR 7936



ROTOR 7935

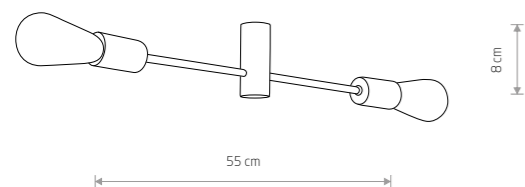

ROTOR
painted steel

7934

2xE27, max 60W

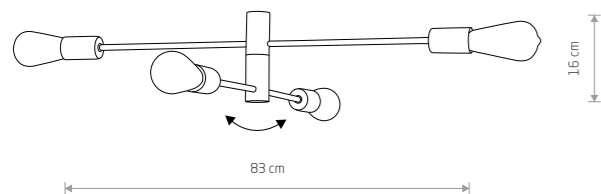

ROTOR
painted steel

7936

4xE27, max 60W

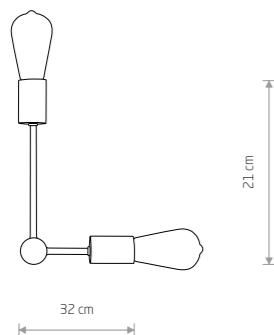

ROTOR
painted steel

7933

2xE27, max 60W

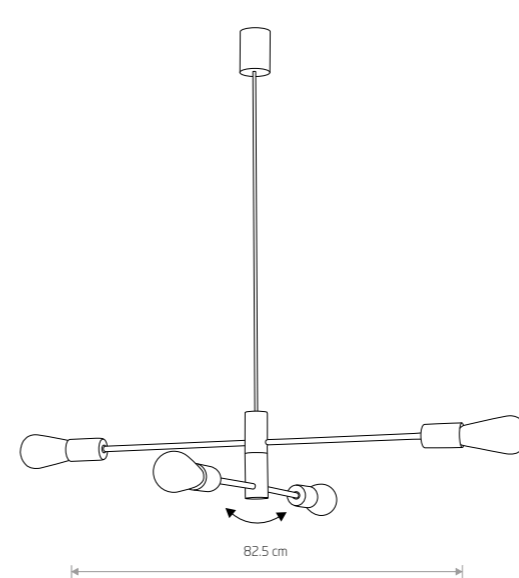

ROTOR
painted steel

7935

4xE27, max 60W

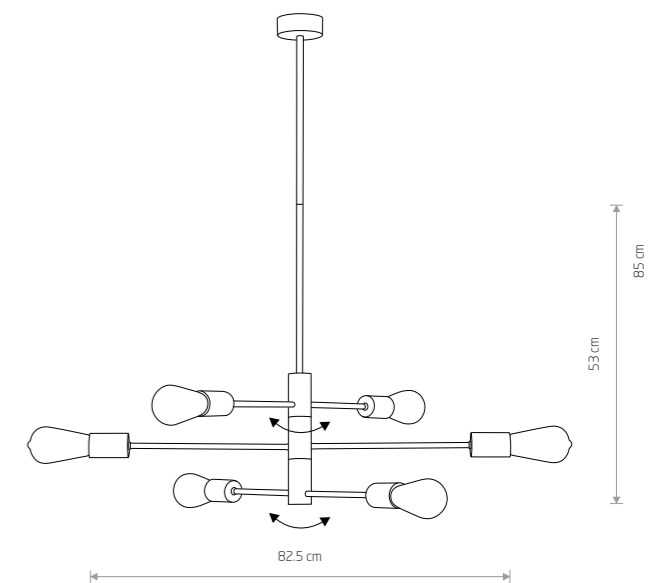

ROTOR
painted steel

7937

6xE27, max 60W

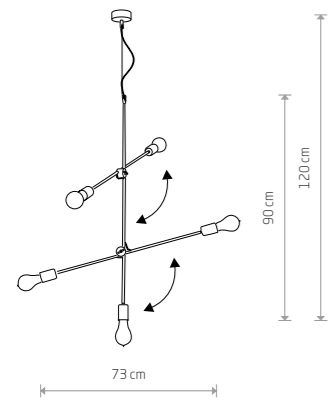

STICKS 9076

STICKS

painting steel

9076 6270

5xE27, max 60W

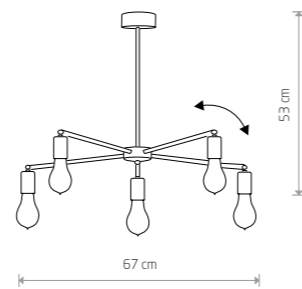
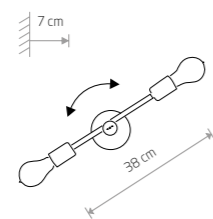
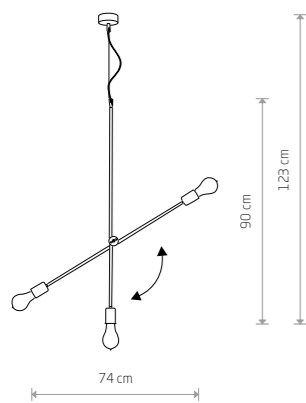

STICKS

painting steel

6268

3xE27, max 60W

STICKS

painting steel

9077 6267

2xE27, max 60W

STICKS

painting steel

9735

5xE27, max 60W



STICKS 6270



AXIS 9294

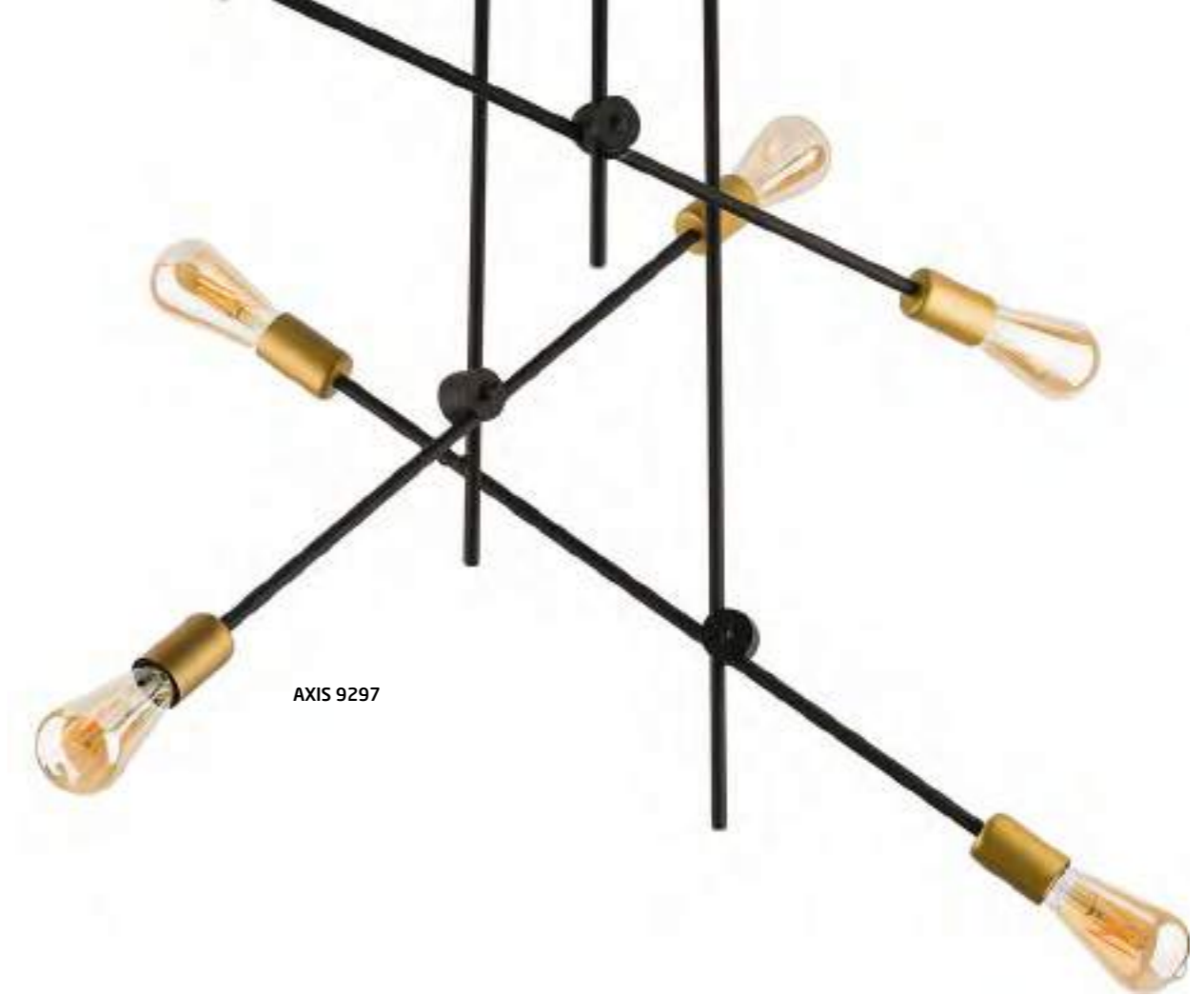

AXIS 9297

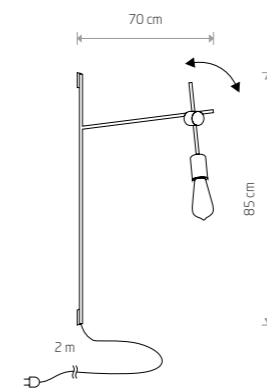

AXIS
painted steel

9294

1xE27, max 60W

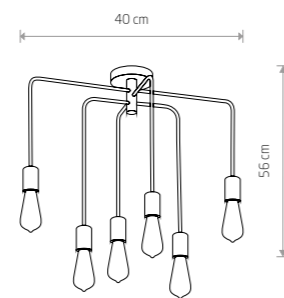

AXIS
painted steel

9296

6xE27, max 60W

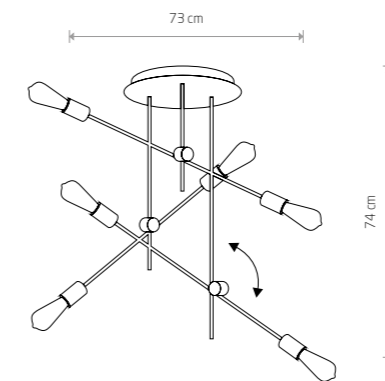

AXIS
painted steel

9297

6xE27, max 60W



ROD 9130

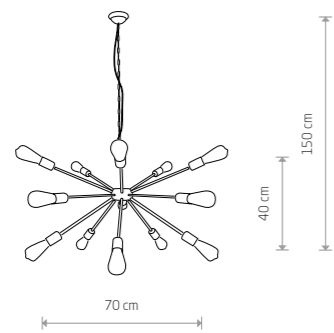

ROD
painted steel

■ 9027 ■ 9733

● 15xE27, max 60W

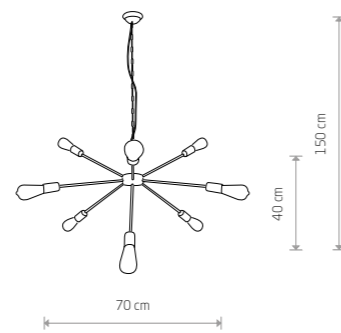

ROD
painted steel

■ 9130 ■ 9734

● 9xE27, max 60W

■ GOLD P017

■ BLACK P013 RAL 9005



ROD 9733



PILE 9127

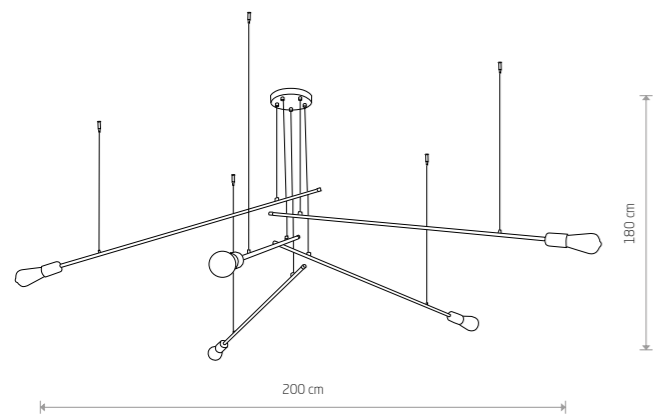

PILE
painted steel, steel

- 9127
- ● 5xE27, max 60W

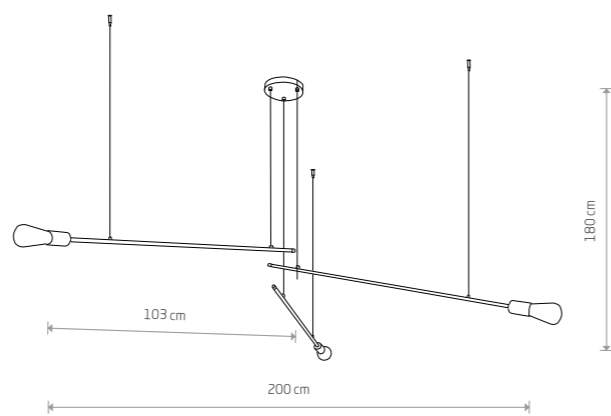

PILE
painted steel, steel

- 9128
- ● 3xE27, max 60W



MILL 9135



MILL 9136

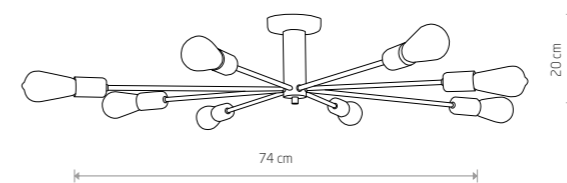

MILL
painted steel, brass-plated steel

- 9135
- ● 8xE27, max 60W

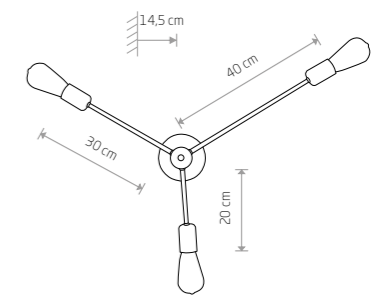

MILL
painted steel, brass-plated steel

- 9136
- ● 3xE27, max 60W

MANUFACTURE 9740

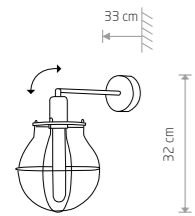

MANUFACTURE
painted steel, copper-clad steel

■ 9742
☑ ☑ 1xE27, max 60W

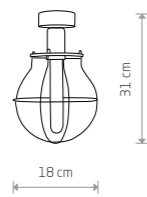

MANUFACTURE
painted steel, copper-clad steel

■ 9741
☑ ☑ 1xE27, max 60W

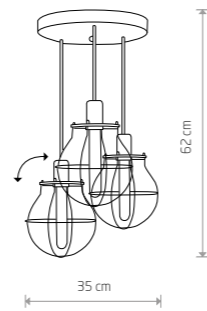

MANUFACTURE
painted steel, copper-clad steel

■ 9740
☑ ☑ ☑ 3xE27, max 60W

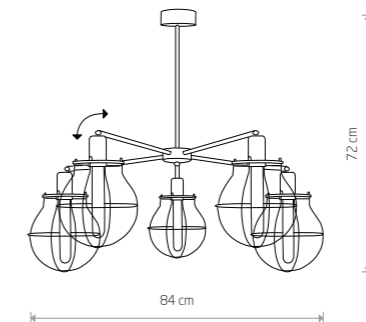

MANUFACTURE
painted steel, copper-clad steel

■ 9738
☑ ☑ ☑ ☑ ☑ 5xE27, max 60W

MANUFACTURE 9742





WORKSHOP A 6337

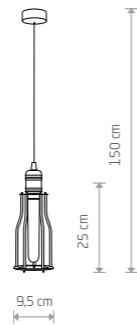

WORKSHOP A
painted steel, copper-clad steel

6337
1xE27, max 60W

WORKSHOP B 6336



WORKSHOP C 6335

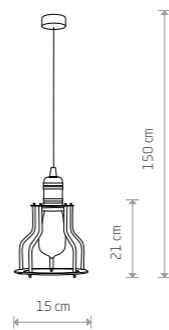

WORKSHOP B
painted steel, copper-clad steel

6336
1xE27, max 60W

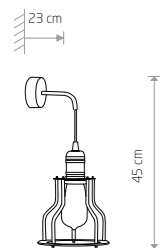

WORKSHOP
painted steel, copper-clad steel

6606
1xE27, max 60W

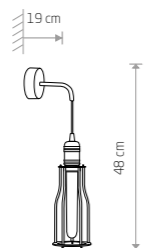

WORKSHOP
painted steel, copper-clad steel

6605
1xE27, max 60W

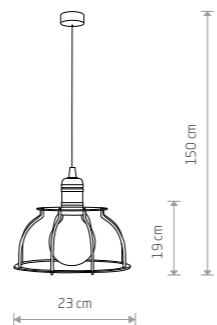

WORKSHOP C
painted steel, copper-clad steel

6335
1xE27, max 60W

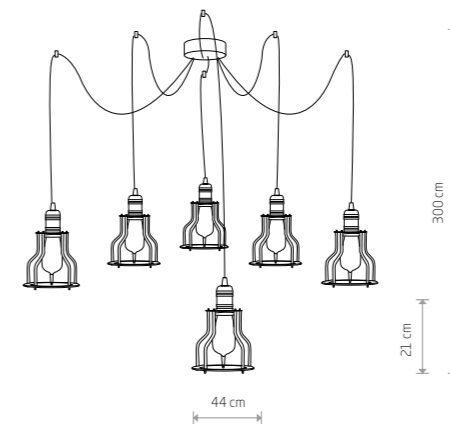

WORKSHOP
painted steel, copper-clad steel

9631
6xE27, max 60W

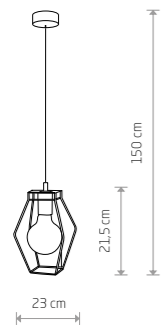

FIORD
painted steel

■ 9670

● 1xE27, max 60W



FIORD 9666

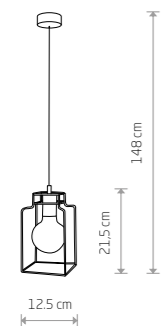

FIORD
painted steel

■ 9668

● 1xE27, max 60W

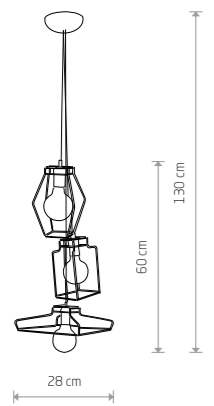

FIORD
painted steel

■ 9666

● 3xE27, max 60W

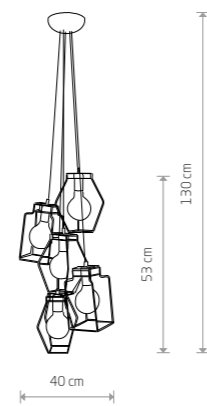

FIORD
painted steel

■ 9665

● 5xE27, max 60W

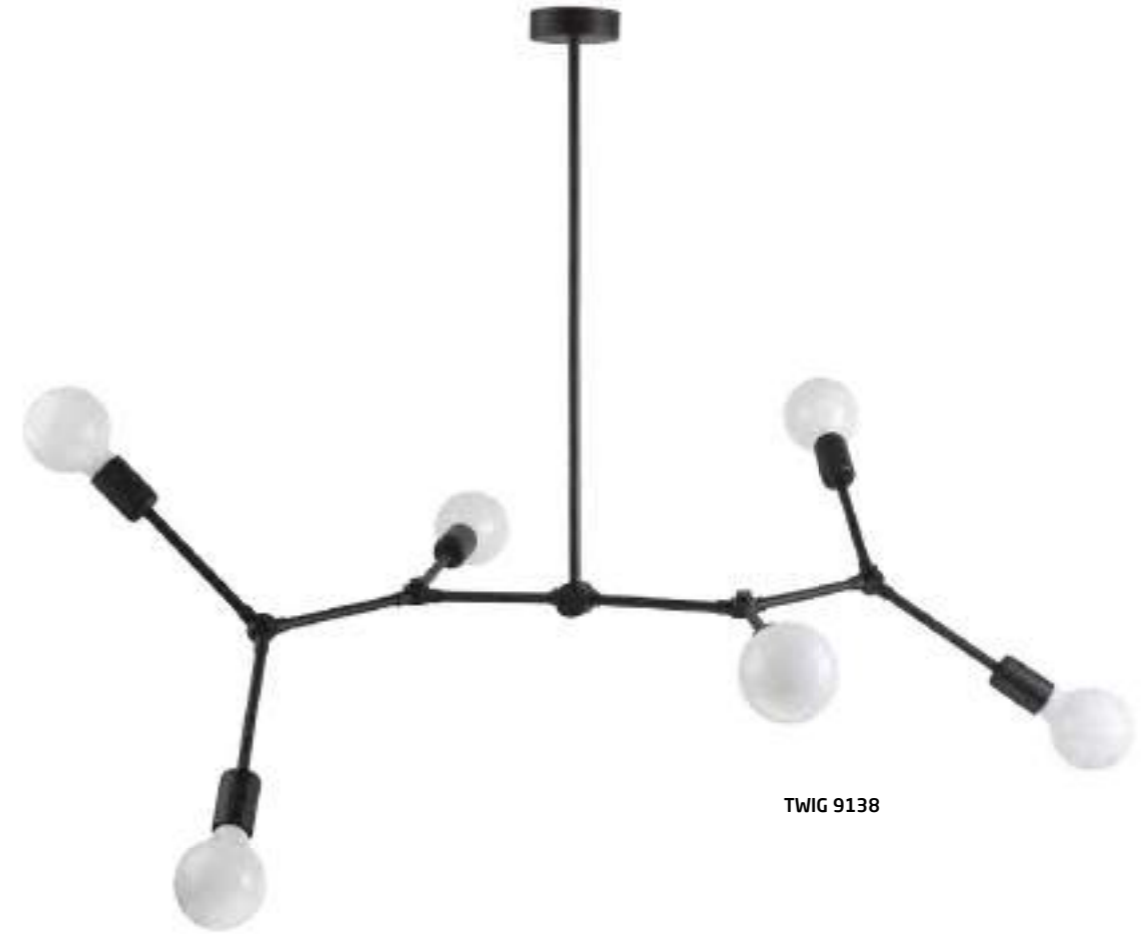

TWIG 9138

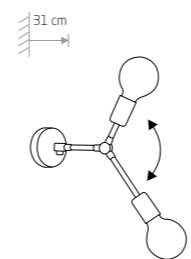

TWIG
painted steel

■ 9141

● 2xE27, max 60W

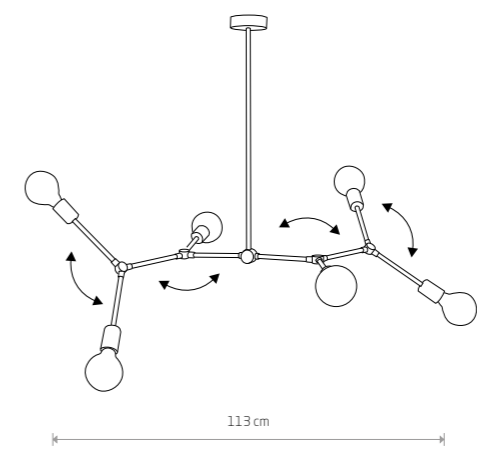

TWIG
painted steel

■ 9138

● 6xE27, max 60W

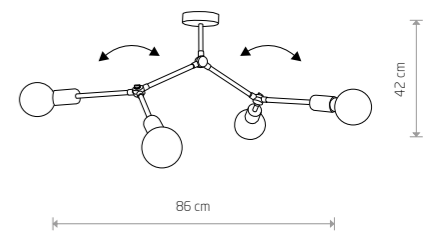

TWIG
painted steel

■ 9140

● 4xE27, max 60W



SPIDER 6785

X+Y=max 300 cm

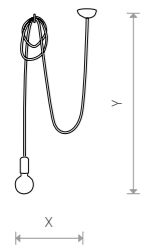

SPIDER
braided cable, painted steel

9745 6792

1x E27, max 60W

X+Y=max 300 cm

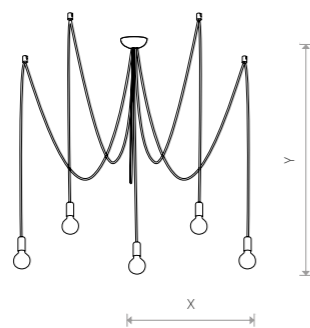

SPIDER
braided cable, painted steel

9744 6788

5x E27, max 60W

X+Y=max 300 cm

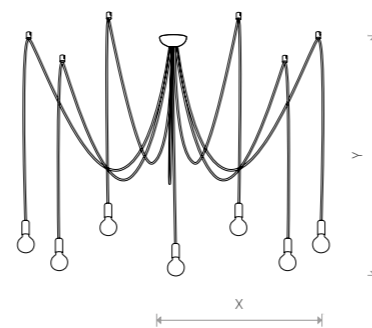

SPIDER
braided cable, painted steel

9743 6785

7x E27, max 60W

WHITE P004 RAL 9003 BLACK P013 RAL 9005



SPIDER 6788

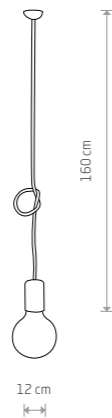

CABLE
braided cable, painted steel, brass-plated steel
9747
1xE27, max 60W



CABLE
braided cable, painted steel, brass-plated steel
9746
7xE27, max 60W



TULUM 9691



TULUM
concrete, painted steel
9691
1xE27, max 60W



SILICONE 6404

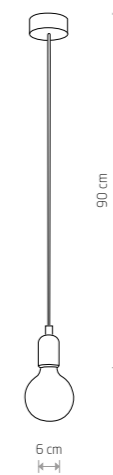

SILICONE
silicone, painted steel
6404 6403
1xE27, max 60W



SILICONE 6403



GEOMETRIC 9695



SHY 9391

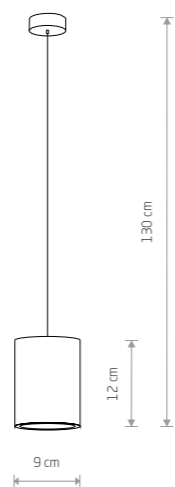

SHY
concrete, painted steel

9391
1xGU10, max 35W

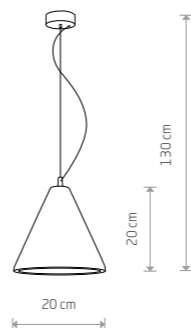

VOLCANO S
concrete, painted steel, chrome

6853
1xGU10, max 35W



LAVA 6855

VOLCANO S 6853

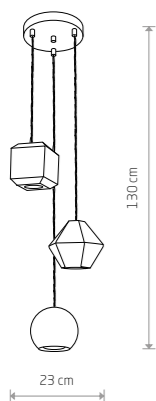

GEOMETRIC
concrete, painted steel

9695
3xGU10, max 35W

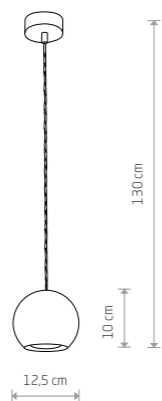

GEOMETRIC
concrete, painted steel

9696
1xGU10, max 35W

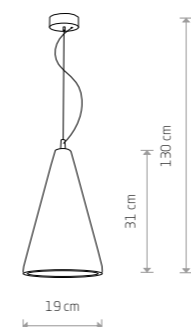

VOLCANO L
concrete, painted steel, chrome

6852
1xE27, max 60W

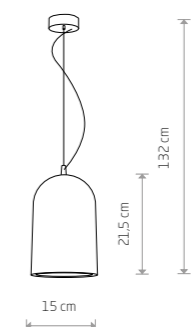

LAVA
concrete, painted steel, chrome

6855
1xE27, max 60W

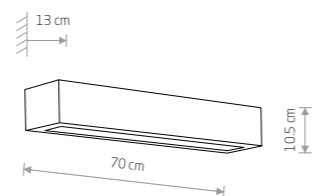
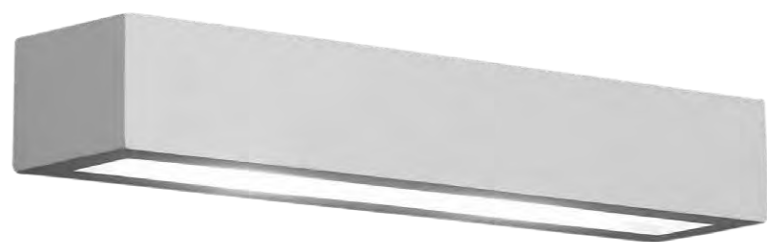

GIPSY L

gypsum, glass

2208

2xE27, max 60W

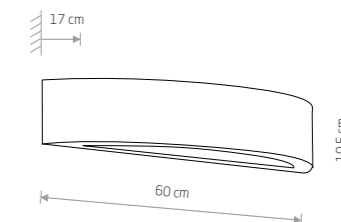

GIPSY L

gypsum, glass

2411

2xE27, max 60W

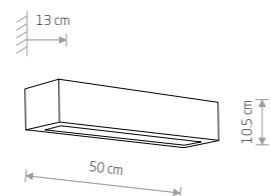

GIPSY M

gypsum, glass

2207

2xE27, max 60W

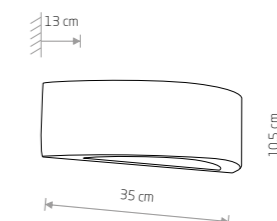

GIPSY S

gypsum, glass

2410

1xE27, max 60W

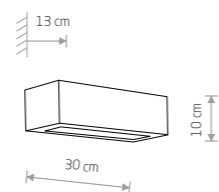

GIPSY S

gypsum, glass

2206

1xE27, max 60W



SOLID 9721

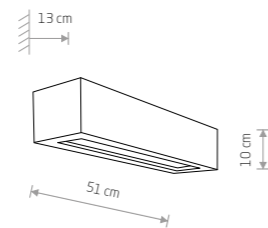

SOLID
concrete, glass

9721

2xE27, max 60W

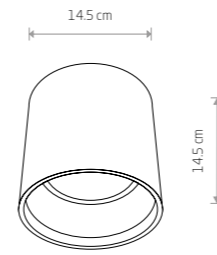

SHY M

concrete

9393

1xGU10 ES111, max 75W

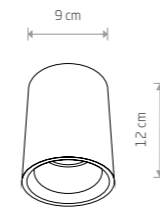

SHY S

concrete

9390

1xGU10, max 35W

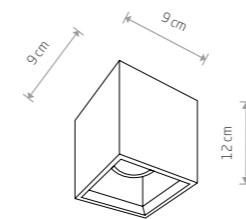

BOLD S

concrete

9388

1xGU10, max 35W

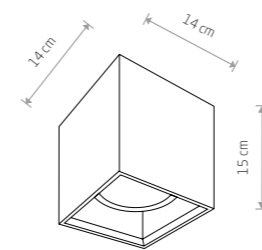

BOLD M

concrete

9392

1xGU10 ES111, max 75W

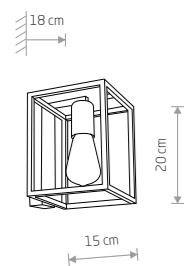

CRATE
painted steel

■ 9046
● 1xE27, max 60W

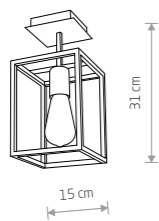

CRATE
painted steel

■ 9045
● 1xE27, max 60W

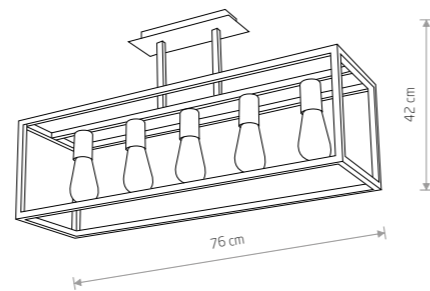

CRATE
painted steel

■ 9047
● 5xE27, max 60W



CRATE 9047



PLANT 9381

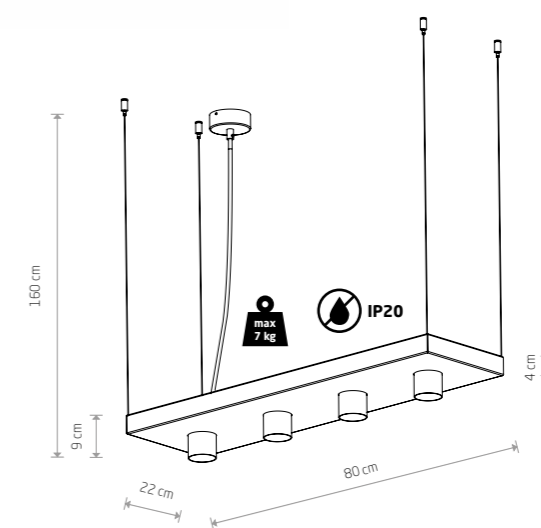

PLANT

■ painted steel, steel

■ 9382 ■ 9381

● 4xGU10, max 35W

■ BLACK P013 RAL 9005 ■ WHITE P004 RAL 9003



EYE TONE 8931



HERMANOS 8100



HERMANOS 8103



HERMANOS 8194



HERMANOS 8037

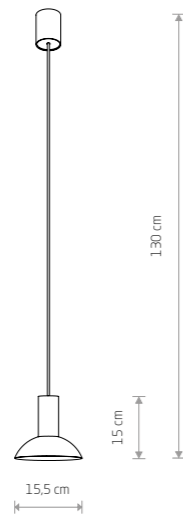

HERMANOS

painting steel, solid brass

8037 8194

1xGU10, max 10W only LED

HERMANOS

painting steel, solid brass

8031 8030

3xGU10, max 10W only LED

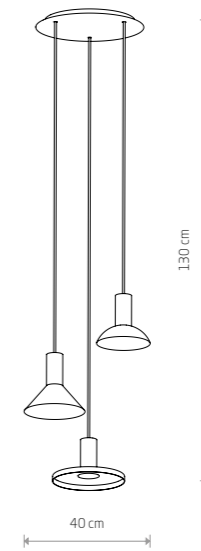

HERMANOS 8031



HERMANOS 8038

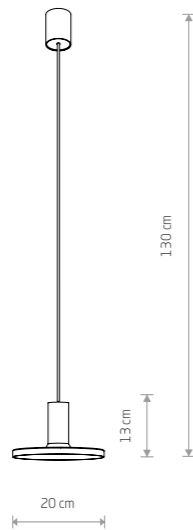

HERMANOS

painting steel, solid brass

8038 8100

1xGU10, max 10W only LED



HERMANOS 8040

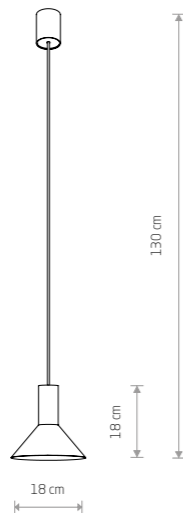

HERMANOS

painting steel, solid brass

8040 8103

1xGU10, max 10W only LED



HERMANOS 8032

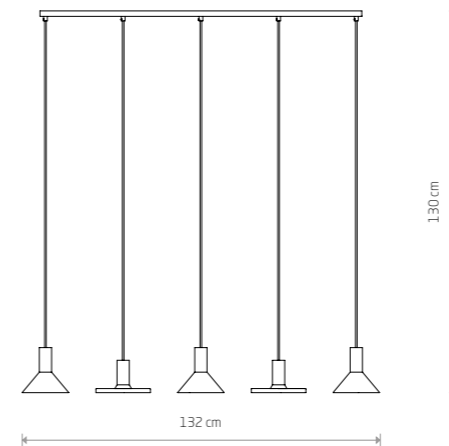

HERMANOS

painting steel, solid brass

8033 8032

5xGU10, max 10W only LED

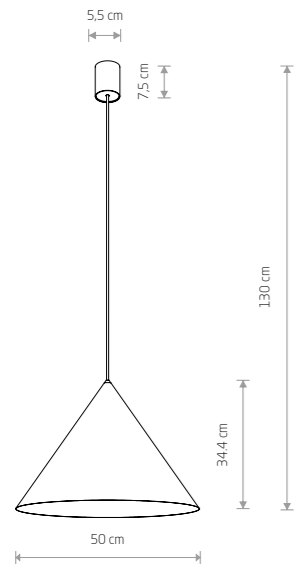

ZENITH L
painted steel, solid brass

■ 8005 ■ 8006 ■ 8007

⚪ 1xGU10, max 35W

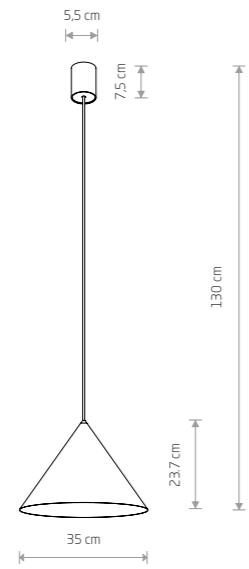

ZENITH M
painted steel, solid brass

■ 8001 ■ 8002 ■ 8003

⚪ 1xGU10, max 35W

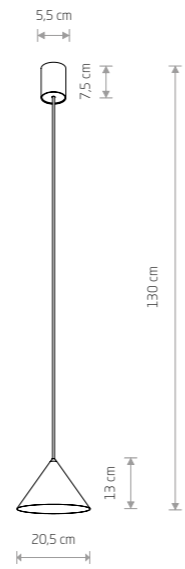

ZENITH S
painted steel, solid brass

■ 7996 ■ 7997 ■ 7998

⚪ 1xGU10, max 35W

■ BLACK P013 RAL 9005 ■ WHITE P004 RAL 9003 ■ GREEN P024 ■ BRASS



ZENITH M 8001



PERM 9146

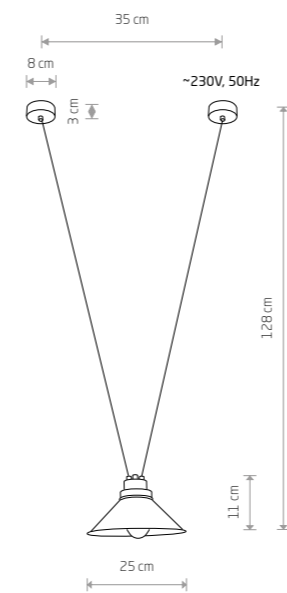

PERM
painted steel

9148

1xE27, max 60W

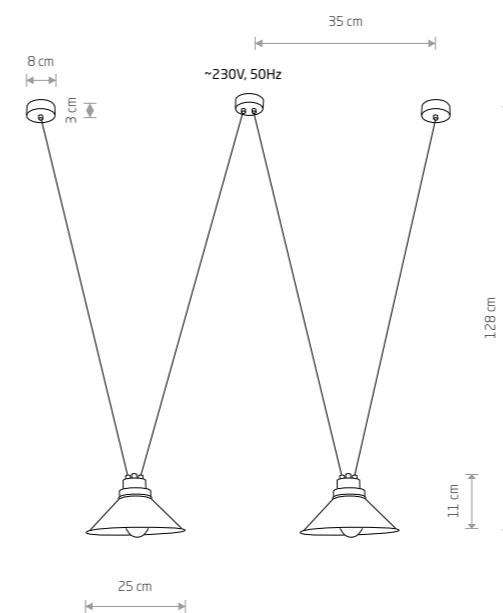

PERM
painted steel

9147

2xE27, max 60W

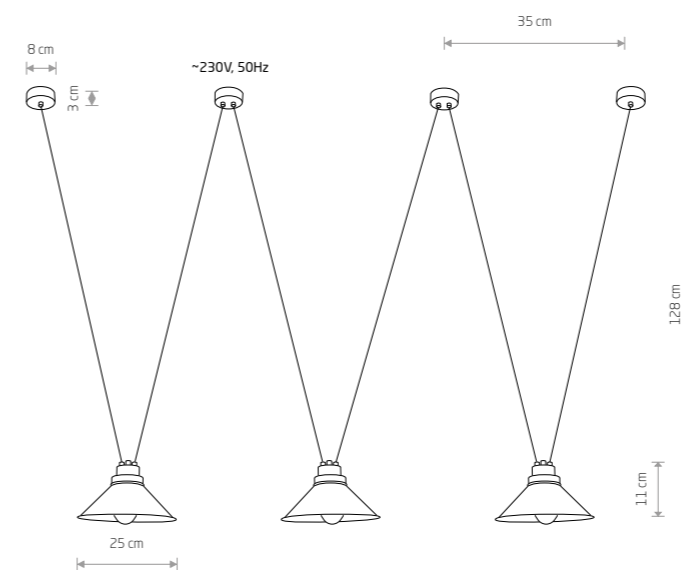

PERM
painted steel

9146

3xE27, max 60W



PERM 9148

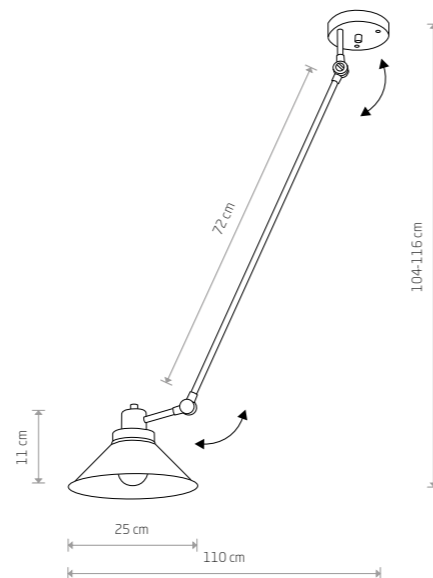
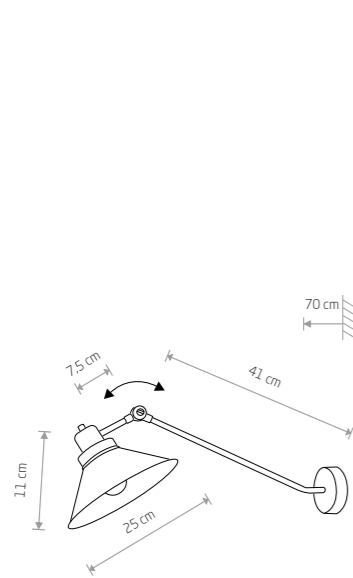

TECHNO
painted steel

- 9145
- 🔦 1xE27, max 60W

TECHNO
painted steel

- 9144
- 🔦 1xE27, max 60W

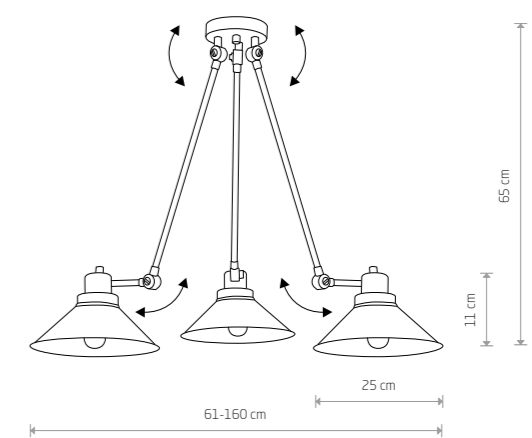
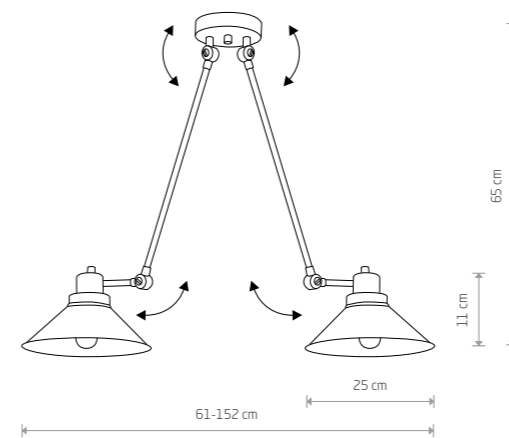

TECHNO
painted steel

- 9143
- 🔦 2xE27, max 60W

TECHNO
painted steel

- 9142
- 🔦 3xE27, max 60W



PANTOGRAPH 9126

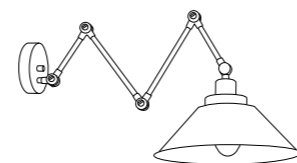
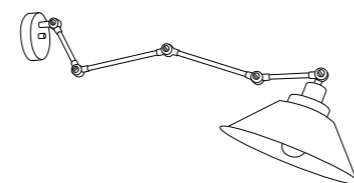
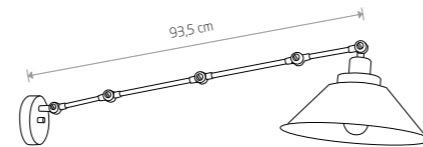
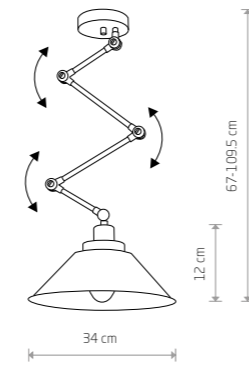

PANTOGRAPH
painted steel

9126

1xE27, max 60W



CRAFT 9150



CRAFT 9151

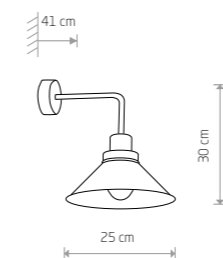

CRAFT
painted steel

9151

1xE27, max 60W

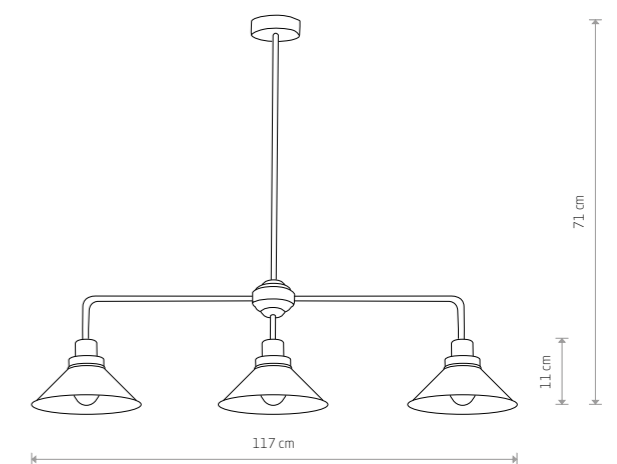

CRAFT
painted steel

9150

3xE27, max 60W



HARMONY 9890

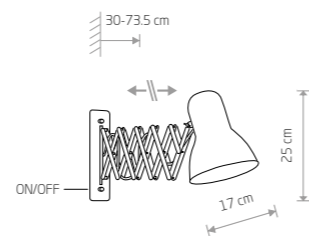

HARMONY
 painted steel, chrome

6868 9890

1xE27, max 60W



HIGH-BAY 5067

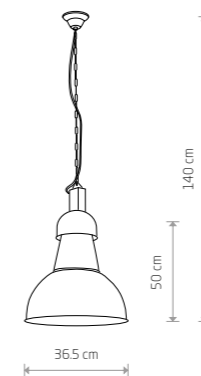

HIGH-BAY
 painted steel

5067

1xE27, max 60W

WHITE P004 RAL 9003 BLACK P013 RAL 9005

BLACK P013 RAL 9005 WHITE P001 RAL 9003



GARRET 6444

GARRET 9247

GARRET 6442



GARRET 6444



GARRET
painted steel

9247

1xE27, max 60W



GARRET
painted steel

6442

1xE27, max 60W

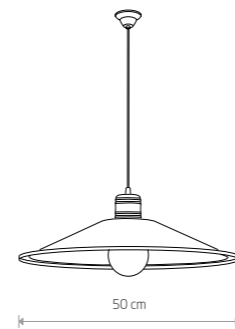

GARRET M
painted steel

6444

1xE27, max 60W

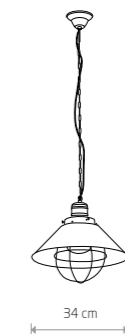

GARRET S
painted steel

6443

1xE27, max 60W

CHOCOLATE P019

COPPER P020



HEMISPHERE RUST L 6368

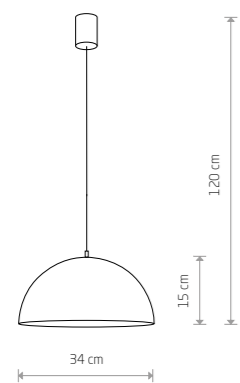

HEMISPHERE RUST S
painted steel

■ 6367

● 1xE27, max 60W

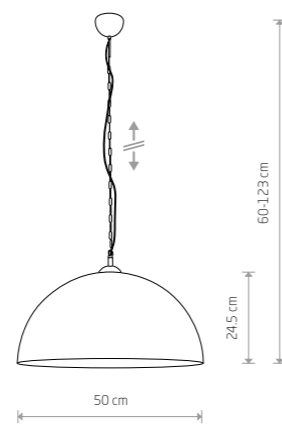

HEMISPHERE RUST L
painted steel

■ 6368

● 1xE27, max 60W



HEMISPHERE RUST L 6368

WORKS 6510



WORKS 6613

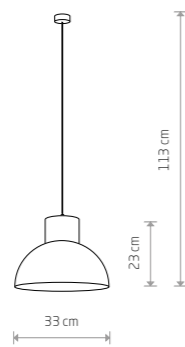

WORKS
painted steel

- 6612
- 6613
- 6510

1xE27, max 60W

HEMISPHERE HIT S 6777



HEMISPHERE HIT L 6778

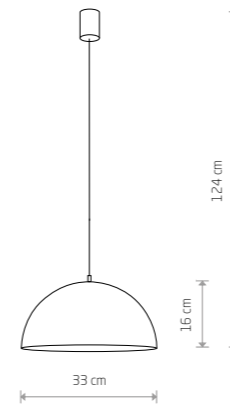

HEMISPHERE HIT S
painted steel

- 6777

1xE27, max 60W

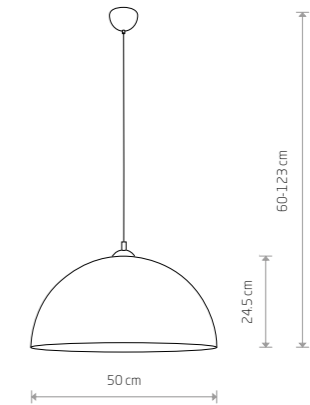

HEMISPHERE HIT L
painted steel

- 6778

1xE27, max 60W



HEMISPHERE L 4843

HEMISPHERE L 4844



HEMISPHERE S 4893



HEMISPHERE S 4841

HEMISPHERE L 4856

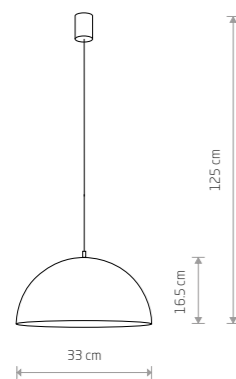

HEMISPHERE S
painted steel, plastic

- 4838
- 4840
- 4893

● 1xE27, max 60W

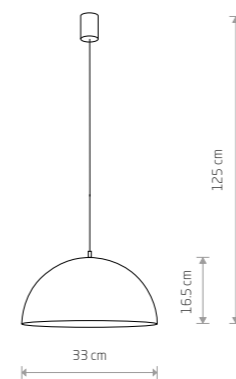

HEMISPHERE S
painted steel, plastic

- 4841

● 1xE27, max 60W

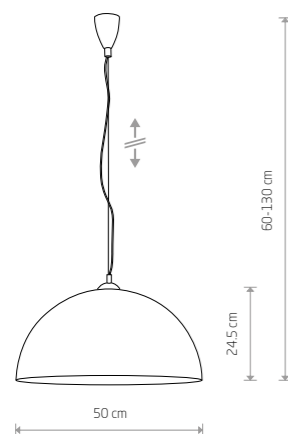

HEMISPHERE L
painted steel, plastic

- 4843
- 4844
- 4842

● 1xE27, max 60W

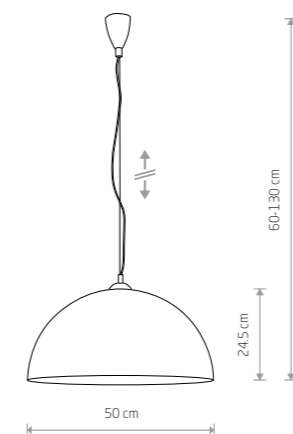

HEMISPHERE L
painted steel, plastic

- 4856

● 1xE27, max 60W



EGG L 9024



EGG L 9023

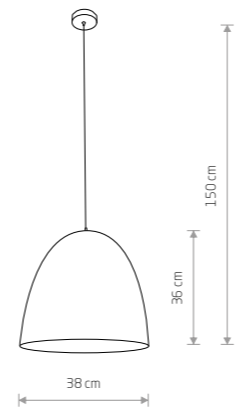

EGG M
composite, painted steel
9022 9021
1xE27, max 40W



EGG XL 9026

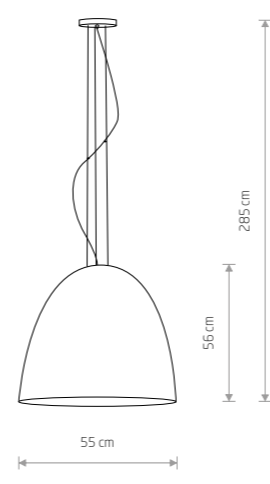

EGG L
composite, painted steel, steel
9024 9023
5xE27, max 40W

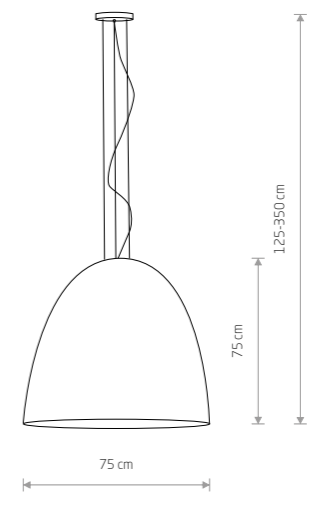

EGG XL
composite, painted steel, steel
9026 9025
7xE27, max 40W



CANOE 7926

CANOE 7927

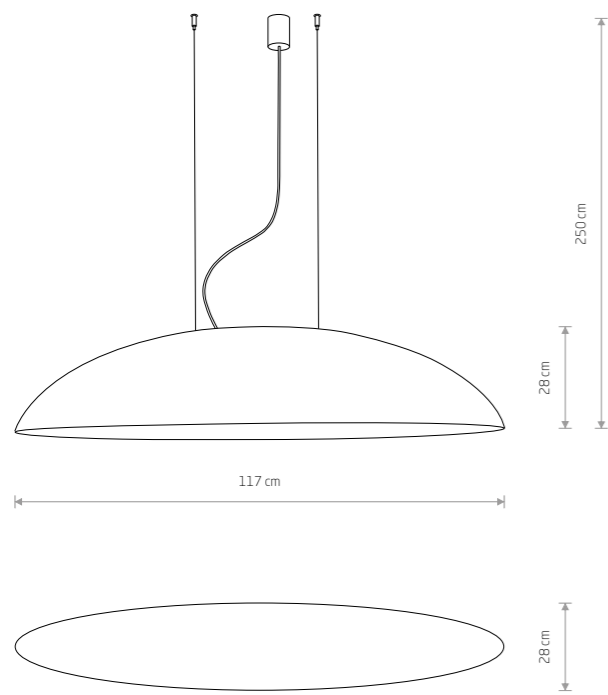

CANOE

composite, painted steel, steel

7926 7927

5xE27, max 40W



CANOE 7926

LUKSOR L 8850





LUKSOR L 8847

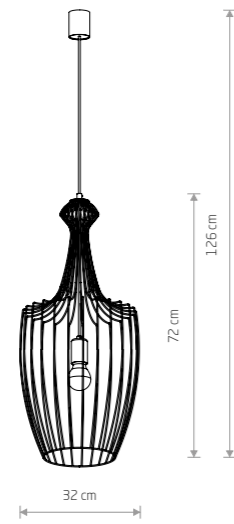

LUKSOR L
painted steel

- 8847
- 1xE27, max 60W
- 8850
- 1xE27, max 60W

brass-plated steel, painted steel

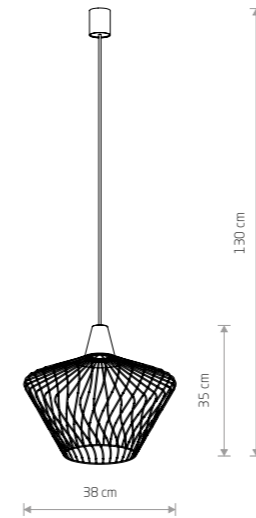

WAVE S
painted steel

- 8860 ■ 8858
- 1xE27, max 60W
- 8861
- 1xE27, max 60W

brass-plated steel, painted steel



WAVE S 8860



WAVE S 8861



LUKSOR S 8851

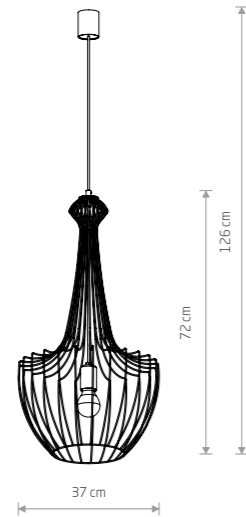

LUKSOR S
painted steel

- 8851
- 1xE27, max 60W
- 8853
- 1xE27, max 60W

brass-plated steel, painted steel

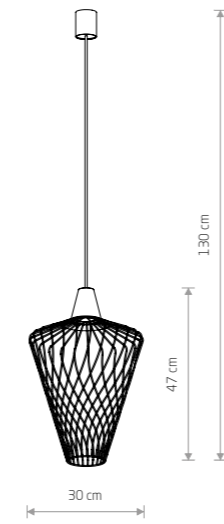

WAVE L
painted steel

- 8856
- 1xE27, max 60W
- 8857
- 1xE27, max 60W

brass-plated steel, painted steel



WAVE L 8856



ABI M 8866



ABI S 8870



ABI L 8864

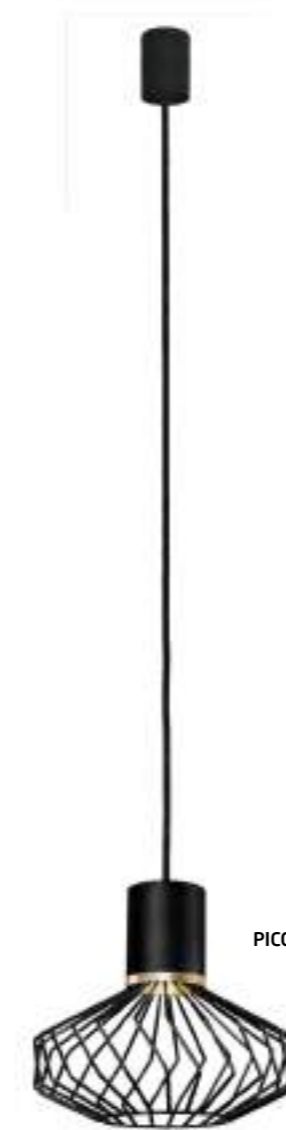

PICO 8862



PICO 8863

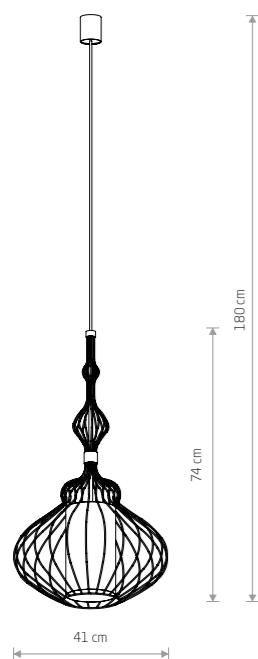

ABI M
painted steel, fabric

■ 8866

⚡ 1xE27, max 40W

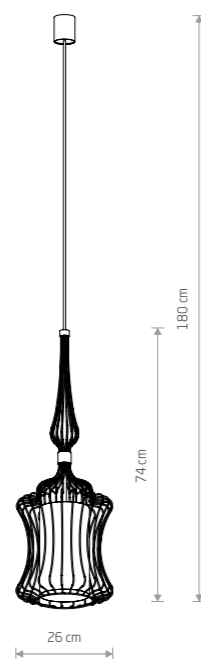

ABI S
painted steel, fabric

■ 8870

⚡ 1xE27, max 40W

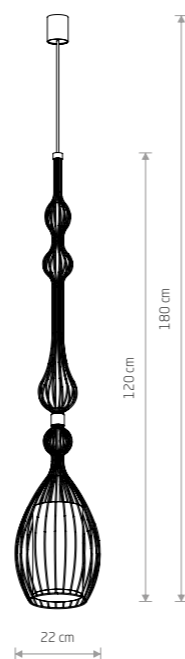

ABI L
painted steel, fabric

■ 8864 □ 8865

⚡ 1xE27, max 40W

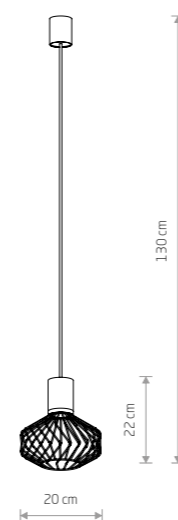

PICO
painted steel, brass-plated steel

■ 8862

⚡ 1xGU10, max 35W

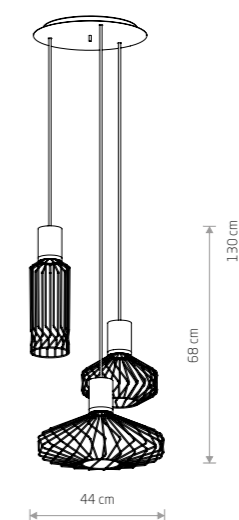

PICO
painted steel, brass-plated steel

■ 8863

⚡ 3xGU10, max 35W

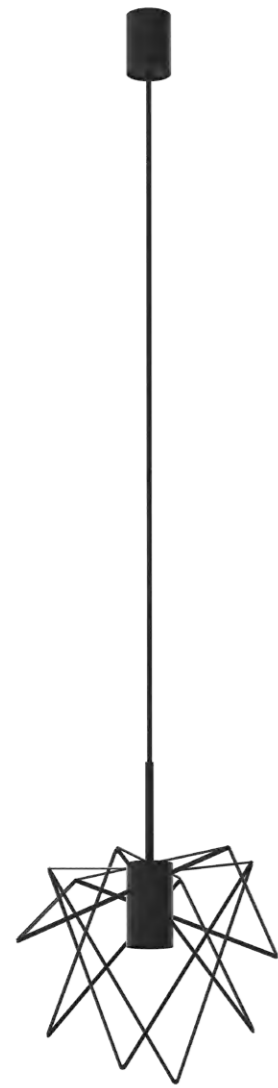

GSTAR 7795

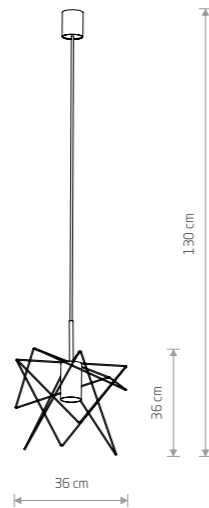

GSTAR

■ painted steel

■ 7795

● 1xGU10, max 10W only LED

■ brass-plated steel, painted steel

■ 8854

● 1xGU10, max 10W only LED



GSTAR 8285

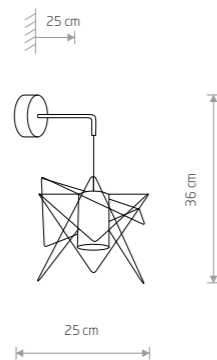

GSTAR

■ painted steel

■ 7796

● 1xGU10, max 10W only LED

■ brass-plated steel, painted steel

■ 8285

● 1xGU10, max 10W only LED



BULLET 9061

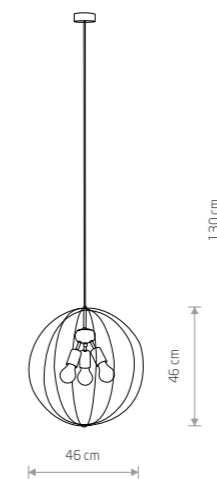

BULLET

■ painted steel

■ 9061

● 3xE27, max 60W



UMBRELLA 8873

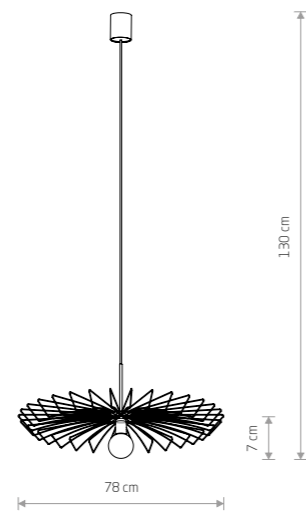

UMBRELLA

8873

8874

1xE27, max 60W

brass-plated steel, painted steel

8874

1xE27, max 60W

NESS

6767

6768

1xE27, max 60W

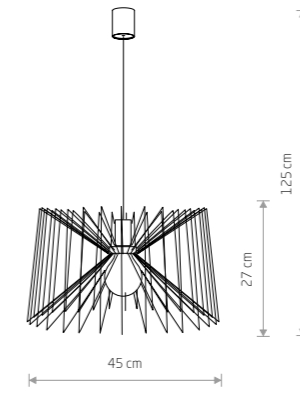

NESS 6767



KAREN 4607

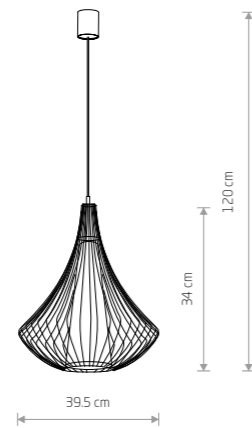

KAREN

4607

4610

1xE27, max 40W

painted steel, fabric

CAGE

6844

6841

1xGU10, max 35W

painted steel

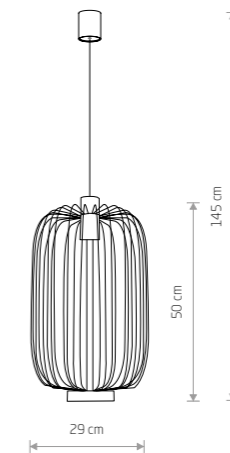

CAGE 6844



CAMILLA 4610

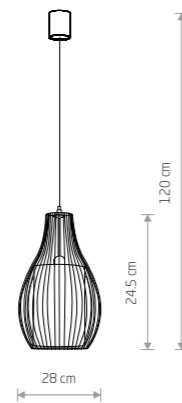

CAMILLA

4611

4610

1xE27, max 40W

painted steel, fabric

ALLAN

6941

6941

1xGU10, max 35W

painted steel

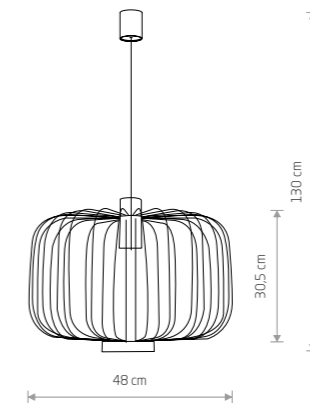

ALLAN 6941





MERSEY 5296



MERSEY

painting steel, glass

5295 5296

1xE27, max 60W



MEKNES 5297



MEKNES

painting steel

5297 5298

1xE27, max 60W



AVEIRO S 5410



AVEIRO S

painting steel, fabric

5410 5411

1xE27, max 40W



AVEIRO L 5126



AVEIRO L

painting steel, fabric

5125 5126

1xE27, max 40W



MARGARET 6330

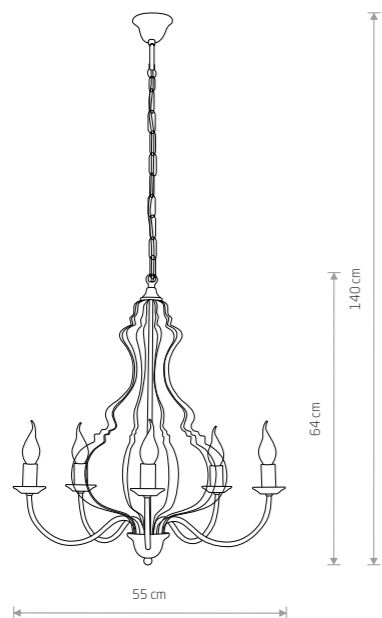

MARGARET
painted steel

6330

5xE14, max 60W



ARES 206

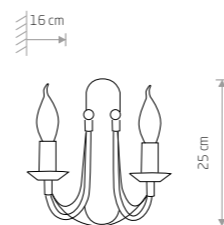

ARES
painted steel

203

2xE14, max 60W

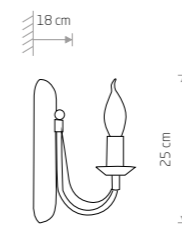

ARES
painted steel

202

1xE14, max 60W

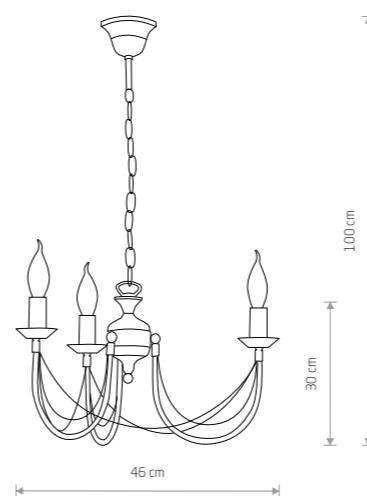

ARES
painted steel

204

3xE14, max 60W

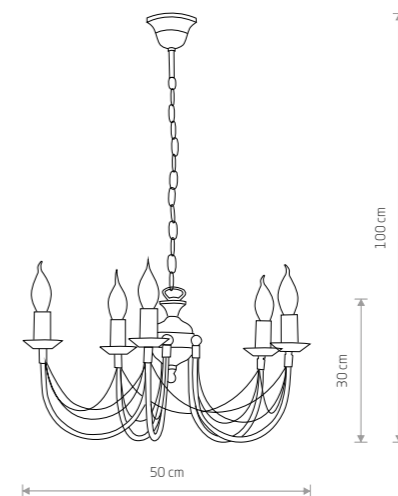

ARES
painted steel

205

5xE14, max 60W

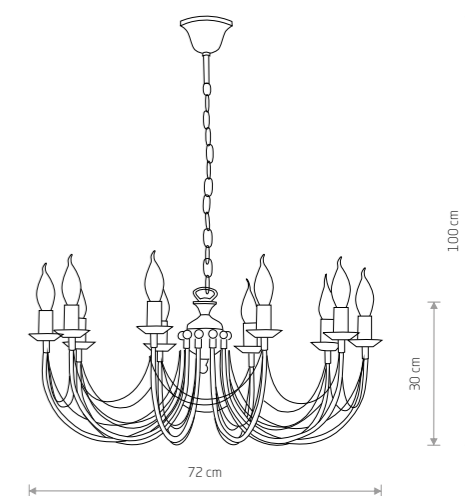

ARES
painted steel

206

10xE14, max 60W



TWIST 4985

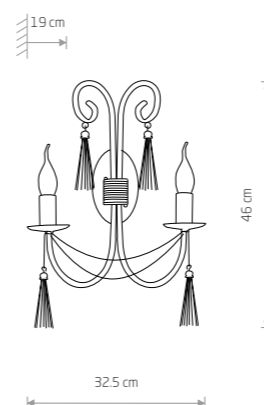

TWIST

painting steel

4981 2763

2xE14, max 60W



TWIST 2763

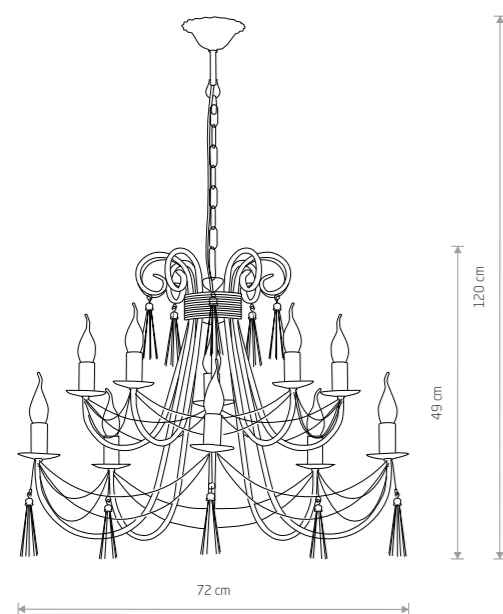

TWIST

painting steel

4985 2767

10xE14, max 60W

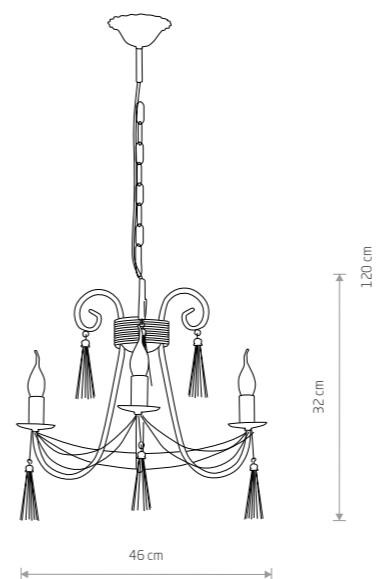

TWIST

painting steel

4983 2764

3xE14, max 60W

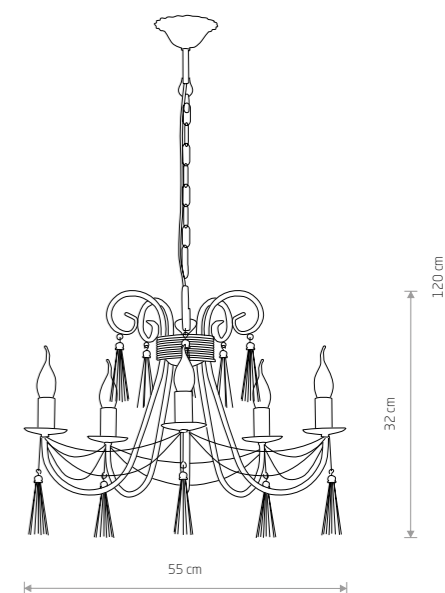

TWIST

painting steel

4984 2766

5xE14, max 60W

REMBRANT LED L 8167



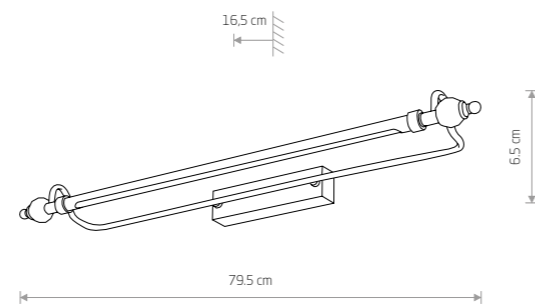
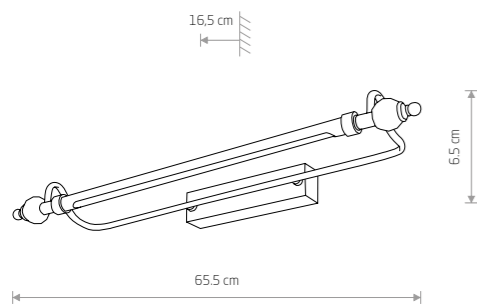

REMBRANT LED M
brass plated steel

8166



REMBRANT LED L
brass plated steel

8167

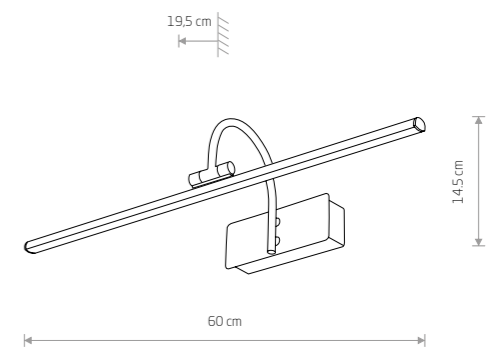
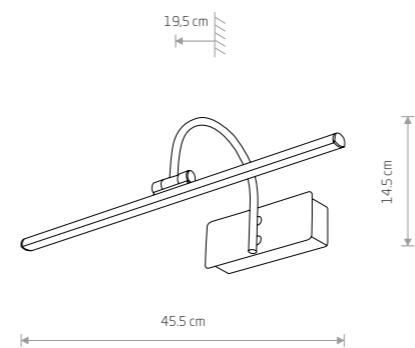

GIOTTO LED S
brass plated steel

8168



GIOTTO LED M
brass plated steel

8170



Item No.	Power	Colour temp.	Luminous flux	Beam angle	Colour Rendering Index (CRI)	Input	Safety type	Power factor	Ingress protection	Lifetime
8166	9W LED	3000K	600 lm	120°	≥80	~220-230 V, 50/60 Hz	⊕	>0,5	IP20	30000h
8167	13W LED	3000K	900 lm	120°	≥80	~220-230 V, 50/60 Hz	⊕	>0,5	IP20	30000h

Item No.	Power	Colour temp.	Luminous flux	Beam angle	Colour Rendering Index (CRI)	Input	Safety type	Power factor	Ingress protection	Lifetime
8168	9W LED	3000K	600 lm	120°	≥80	~220-230V V, 50/60Hz Hz	⊕	>0,5	IP20	30000h
8170	13W LED	3000K	900 lm	120°	≥80	~220-230 V, 50/60 Hz	⊕	>0,5	IP20	30000h

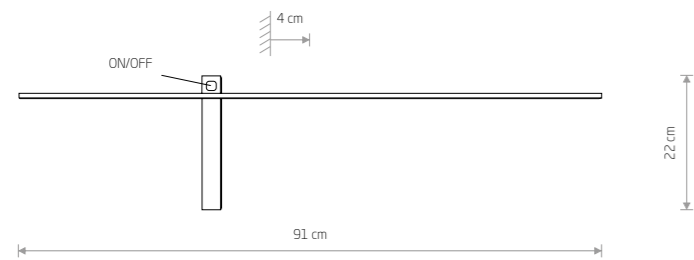

IMPULSE LED M
 painted aluminum, plastic PC

■ 8116



IMPULSE LED S 8115

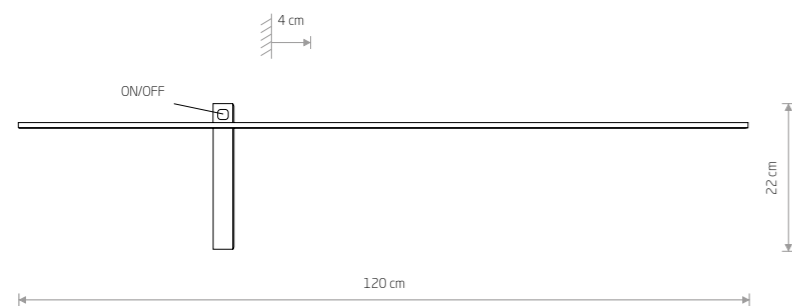

IMPULSE LED L
 painted aluminum, plastic PC

■ 8117

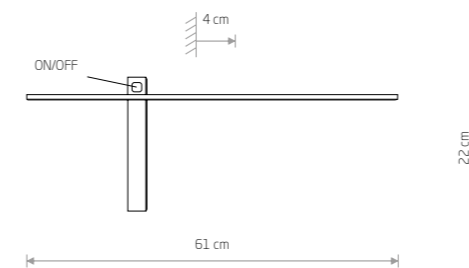

IMPULSE LED S
 painted aluminum, plastic PC

■ 8115



Item No.	Power	Colour temp.	Luminous flux	Beam angle	Colour Rendering Index (CRI)	Input	Safety type	Power factor	Ingress protection	Lifetime
8115	6W LED	3000K	200 lm	120°	≥80	~220-230 V, 50/60 Hz	☐	>0,5	IP23	30000h
8116	10W LED	3000K	350 lm	120°	≥80	~220-230 V, 50/60 Hz	☐	>0,5	IP23	30000h
8117	15W LED	3000K	500 lm	120°	≥80	~220-230 V, 50/60 Hz	☐	>0,5	IP23	30000h



STRAIGHT CEILING LED L 7551



STRAIGHT CEILING LED M 7558



STRAIGHT CEILING LED S 7597



STRAIGHT CEILING LED L

Painted steel, plastic PMMA

7551 7556 7600

1xLED TUBE T8, max 22W, included



STRAIGHT CEILING LED M

Painted steel, plastic PMMA

7553 7558 7598

1xLED TUBE T8, max 16W, included



STRAIGHT CEILING LED S

Painted steel, plastic PMMA

7552 7557 7597

1xLED TUBE T8, max 11W, included

Name	Size	Power	Colour temp.	Luminous flux	Beam angle	Colour Rendering Index (CRI)	Input	Power factor	Lifetime	Material
LED TUBE T8	60 cm	11W LED	3000K	1700 lm	120°	≥80	220-230 V, 50/60 Hz	>0,5	30000h	CLEAR GLASS
LED TUBE T8	90 cm	16W LED	3000K	2300 lm	120°	≥80	220-230 V, 50/60 Hz	>0,5	30000h	CLEAR GLASS
LED TUBE T8	120 cm	22W LED	3000K	3200 lm	120°	≥80	220-230 V, 50/60 Hz	>0,5	30000h	CLEAR GLASS

GRAPHITE P010 RAL 7016 WHITE P004 RAL 9003 BLACK P013 RAL 9005

STRAIGHT CEILING LED M 7558



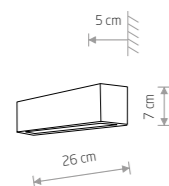

STRAIGHT WALL XS

Painted steel, plastic PMMA

- 6345 6354
- 6350 7601

1xE14, max 40W

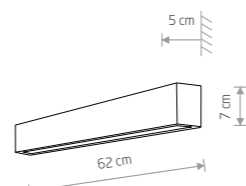

STRAIGHT WALL LED S

Painted steel, plastic PMMA

- 7568 7565
- 7562 7596

1xLED TUBE T8, max 11W, included

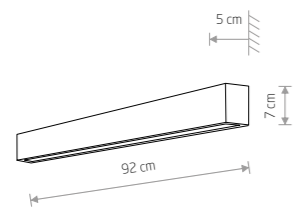

STRAIGHT WALL LED M

Painted steel, plastic PMMA

- 7567 7564
- 7561 7594

1xLED TUBE T8, max 16W, included

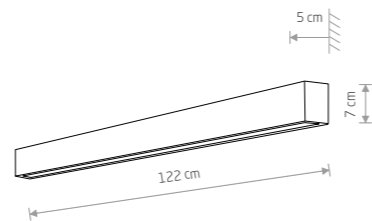

STRAIGHT WALL LED L

Painted steel, plastic PMMA

- 7566 7563
- 7560 7595

1xLED TUBE T8, max 22W, included

Name	Size	Power	Colour temp.	Luminous flux	Beam angle	Colour Rendering Index (CRI)	Input	Power factor	Lifetime	Material
LED TUBE T8	60 cm	11W LED	3000K	1700 lm	120°	≥80	220-230 V, 50/60 Hz	>0,5	30000h	CLEAR GLASS
LED TUBE T8	90 cm	16W LED	3000K	2300 lm	120°	≥80	220-230 V, 50/60 Hz	>0,5	30000h	CLEAR GLASS
LED TUBE T8	120 cm	22W LED	3000K	3200 lm	120°	≥80	220-230 V, 50/60 Hz	>0,5	30000h	CLEAR GLASS

WHITE P004 RAL 9003 SILVER P006 RAL 9006 GRAPHITE P010 RAL 7016 BLACK P013 RAL 9005



H LED 8910

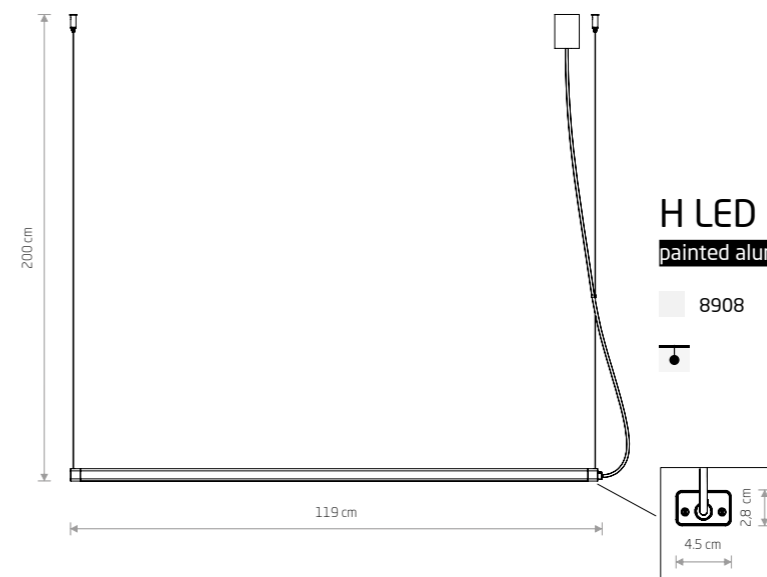

H LED

Painted aluminum, plastic PC, painted steel

- 8908 8910



Item No.	Power	Colour temp.	Luminous flux	Luminaire efficiency	Colour Rendering Index (CRI)	Input	Lifetime
8908 8910	36W LED	3000K	2300 lm	75	≥ 80	~220-230 V, 50/60 Hz	50000h

WHITE P004 RAL 9003 WHITE-BLACK



SOFT LED 90X6 7547

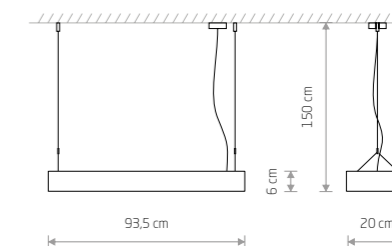

SOFT LED 90X20 7532

**SOFT LED 90X20**

painted aluminum, plastic PMMA

7545 7532

2xLED TUBE T8, max 16W, included

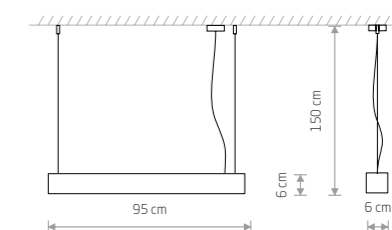

SOFT LED 90X6 7547

**SOFT LED 90X6**

painted aluminum, plastic PMMA

7547 7535

1xLED TUBE T8, max 16W, included

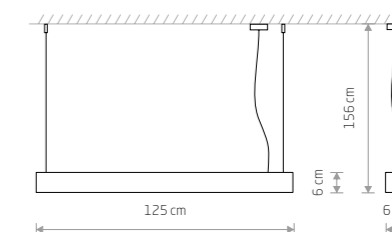

SOFT LED 120X6 7525

**SOFT LED 120X6**

painted aluminum, plastic PMMA

7537 7525

1xLED TUBE T8, max 22W, included

SOFT CEILING LED 60X6 7540

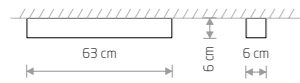

SOFT CEILING LED 60X6

painting aluminum, plastic PMMA

7540 7527

1xLED TUBE T8, max 11W, included

SOFT CEILING LED 60X20 7526

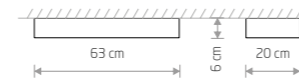

SOFT CEILING LED 60X20

painting aluminum, plastic PMMA

7538 7526

2xLED TUBE T8, max 11W, included

SOFT WALL LED 60X6 7541



SOFT WALL LED 60X6

painting aluminum, plastic PMMA

7541 7528

1xLED TUBE T8, max 11W, included

SOFT CEILING LED 90X6 7533

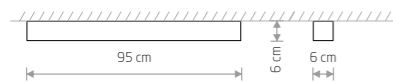

SOFT CEILING LED 90X6

painting aluminum, plastic PMMA

7546 7533

1xLED TUBE T8, max 16W, included

SOFT CEILING LED 90X20 7542

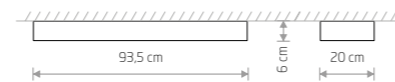

SOFT CEILING LED 90X20

painting aluminum, plastic PMMA

7542 7531

2xLED TUBE T8, max 16W, included

SOFT WALL LED 90X6 7534

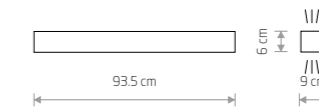

SOFT WALL LED 90X6

painting aluminum, plastic PMMA

7548 7534

1xLED TUBE T8, max 16W, included

SOFT CEILING LED 120X6 7536



SOFT CEILING LED 120X6

painting aluminum, plastic PMMA

7536 7524

1xLED TUBE T8, max 22W, included

SOFT CEILING LED 60X60 7530

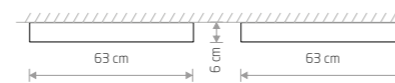

SOFT CEILING LED 60X60

painting aluminum, plastic PMMA

7544 7530

5xLED TUBE T8, max 11W, included

Name	Size	Power	Colour temp.	Luminous flux	Beam angle	Colour Rendering Index (CRI)	Input	Power factor	Lifetime	Material
LED TUBE T8	60 cm	11W LED	3000K	1700 lm	120°	≥80	220-230 V, 50/60 Hz	>0,5	30000h	CLEAR GLASS
LED TUBE T8	90 cm	16W LED	3000K	2300 lm	120°	≥80	220-230 V, 50/60 Hz	>0,5	30000h	CLEAR GLASS
LED TUBE T8	120 cm	22W LED	3000K	3200 lm	120°	≥80	220-230 V, 50/60 Hz	>0,5	30000h	CLEAR GLASS



WING LED 7543

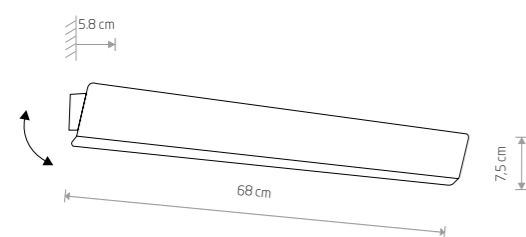

WING LED

painted steel

 7543
 7550

 1xLED TUBE T8, max 11W, included

Name	Size	Power	Colour temp.	Luminous flux	Beam angle	Colour Rendering Index (CRI)	Input	Power factor	LED driver	Lifetime	Material
LED TUBE T8	60 cm	11W LED	3000K	1700 lm	120°	≥80	220-230 V, 50/60 Hz	>0,5	INCL	30000h	CLEAR GLASS

 WHITE P004 RAL 9003

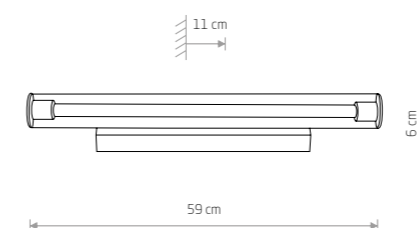
 BLACK P013 RAL 9005

ION LED M

glass, chrome plated steel

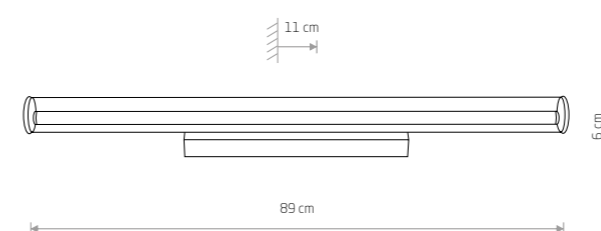
 8171

ION LED L

glass, chrome plated steel

 8172

Item No.	Power	Colour temp.	Luminous flux	Beam angle	Colour Rendering Index (CRI)	Input	Safety type	Power factor	Ingress protection	Lifetime
8171	12W LED	3000K	870 lm	130°	≥80	~220-230 V, 50/60 Hz	⊕	>0,5	IP20	30000h
8172	18W LED	3000K	1300 lm	130°	≥80	~220-230 V, 50/60 Hz	⊕	>0,5	IP20	30000h

 CHROME

CUBE 5272

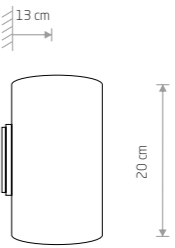

TUBE

painting aluminum

- 9317
- 9318
- 9320

2xGU10 ES111, max 75W

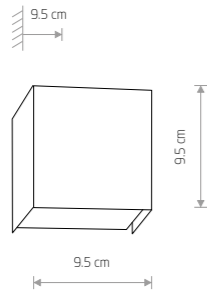

CUBE

painting steel, glass

- 5266
- 5272

1xG9, max 35W

brushed stainless steel, glass

- 5267

1xG9, max 35W

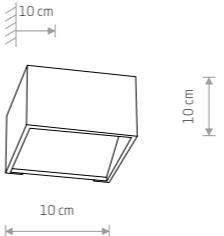

LIA LED

painting aluminum

- 6913

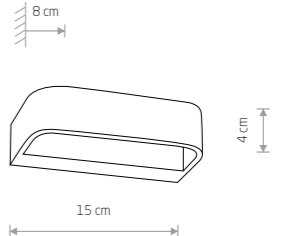

GESS LED

painting aluminum

- 6912

Item No.	Power	Colour temp.	Luminous flux	Beam angle	Colour Rendering Index (CRI)	Input	Safety type	Power factor	Ingress protection	Lifetime
6913	7W LED	3000K	460 lm	89 °	≥ 80	~220-230 V, 50/60 Hz	⊕	>0.5	IP20	10000h
6912	7W LED	3000K	450 lm	47 °	≥ 80	~220-230 V, 50/60 Hz	⊕	>0.5	IP20	10000h

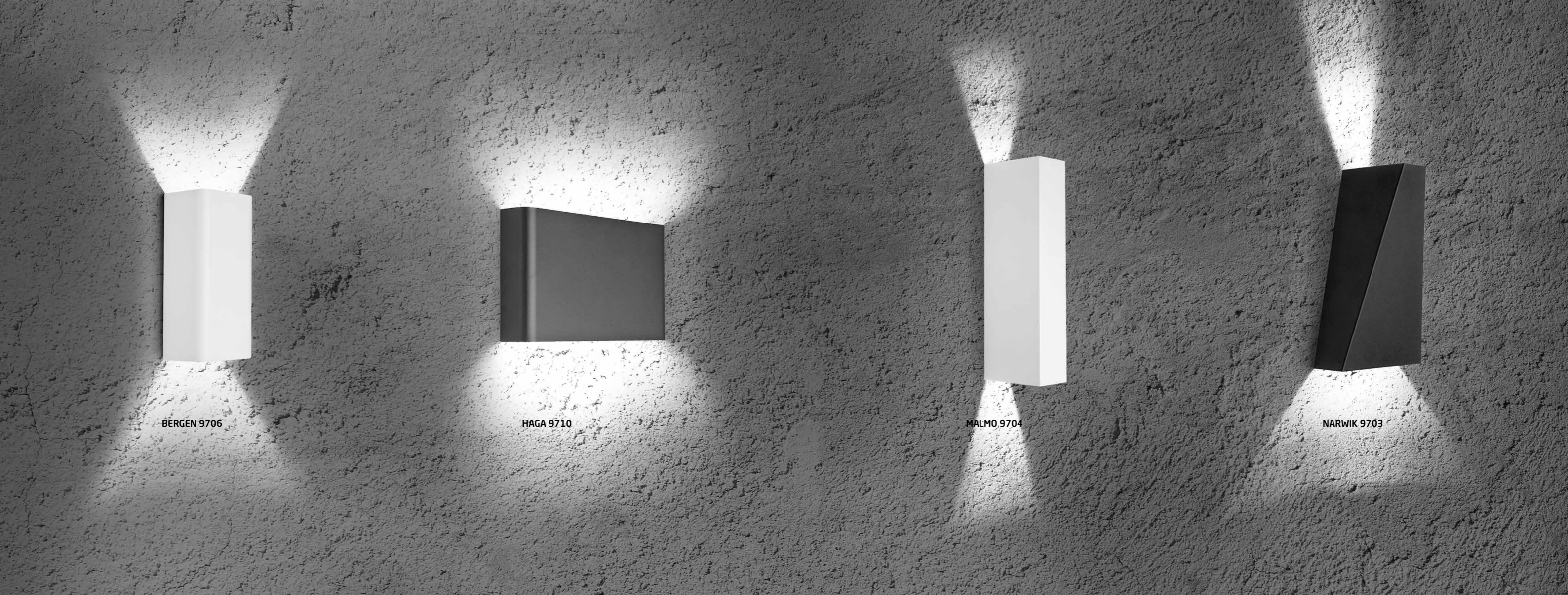

BERGEN 9706

HAGA 9710

MALMO 9704

NARWIK 9703

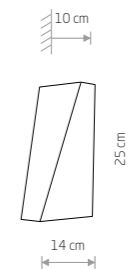
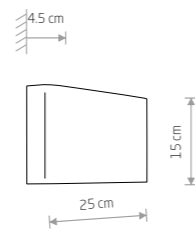
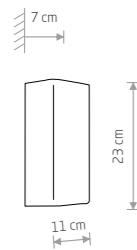

BERGEN

painting steel

9706 9707

2xGU10, max 35W

HAGA

painting steel

9708 9710

2xG9, max 40W

MALMO

painting steel

9704 9705

2xGU10, max 35W

NARWIK

painting steel

9702 9703

2xGU10, max 35W



RING LED M 7638



RING LED S 7634



RING LED S 7637

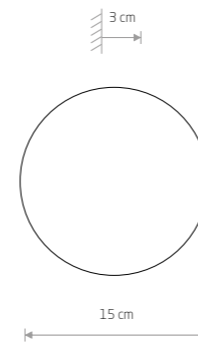

RING LED S
painted steel

■ 7634 ■ 7637

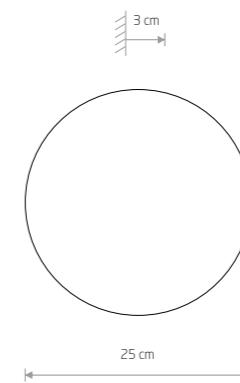

RING LED M
painted steel

■ 7635 ■ 7638

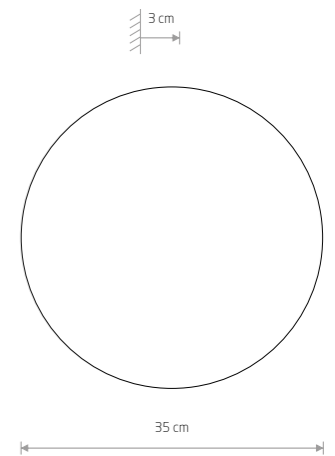

RING LED L
painted steel

■ 7636 ■ 7640



Item No.	Power	Colour temp.	Luminous flux	Beam angle	Colour Rendering Index (CRI)	Input	Safety type	Ingress protection	Lifetime
7634	7W LED	3000K	235 lm	150°	>80	220-230 V, 50/60 Hz	⊕	IP20	50000h
7637	7W LED	3000K	265 lm	150°	>80	220-230 V, 50/60 Hz	⊕	IP20	50000h
7635	9W LED	3000K	400 lm	150°	>80	220-230 V, 50/60 Hz	⊕	IP20	50000h
7638	9W LED	3000K	520 lm	150°	>80	220-230 V, 50/60 Hz	⊕	IP20	50000h
7636	12W LED	3000K	640 lm	150°	>80	220-230 V, 50/60 Hz	⊕	IP20	50000h
7640	12W LED	3000K	780 lm	150°	>80	220-230 V, 50/60 Hz	⊕	IP20	50000h



ORGANIC 8303

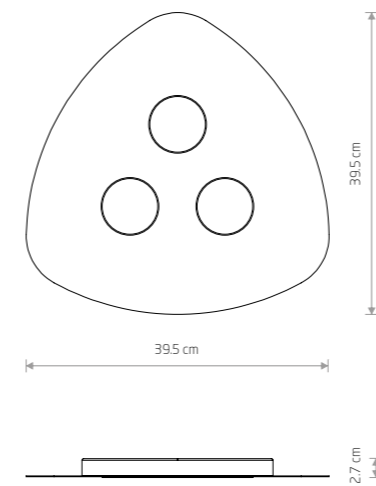

ORGANIC
painted steel

8304 ■ 8302

3xGX53, max 12W

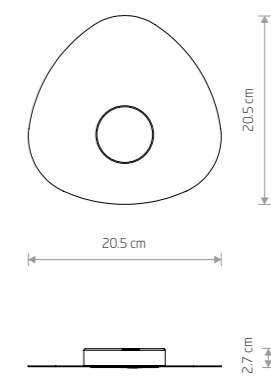

ORGANIC
painted steel

8305 ■ 8303

1xGX53, max 12W

WHITE P004 RAL 9003 ■ BLACK P013 RAL 9005



KASAI 9491



KASAI 9490



KASAI 7952

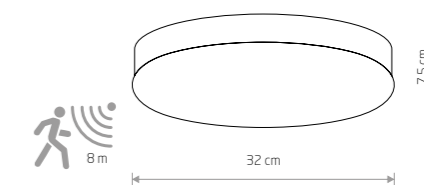
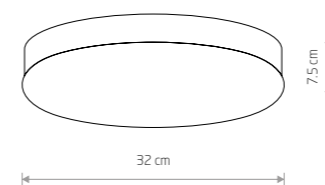

KASAI

glass, chrome plated steel

9490



glass, brushed stainless steel

9491



glass, painted steel

7952



KASAI SENSOR

glass, chrome plated steel

8827



glass, brushed stainless steel

8828



AGNES ROUND LED 8208

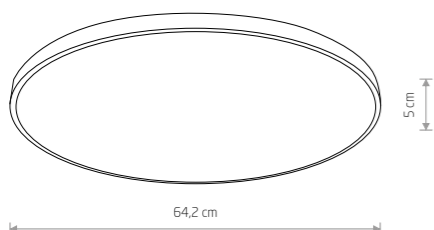
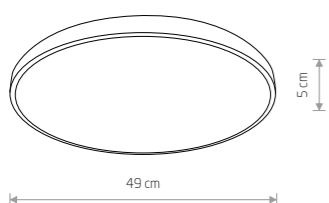
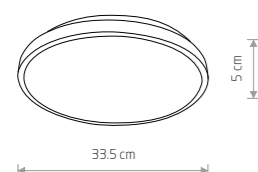

AGNES ROUND LED

painted steel, plastic PMMA

8207 3000K 8204 3000K
8186 4000K 8183 4000K



AGNES ROUND LED

painted steel, plastic PMMA

8208 3000K 8205 3000K
8187 4000K 8184 4000K



AGNES ROUND LED

painted steel, plastic PMMA

8210 3000K 8206 3000K
8188 4000K 8185 4000K



AGNES SQUARE LED 8108

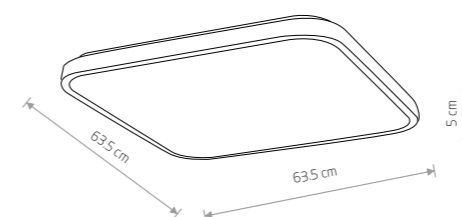
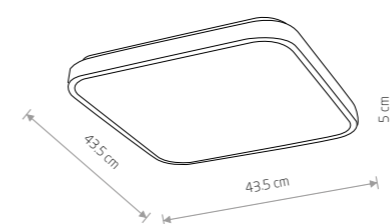
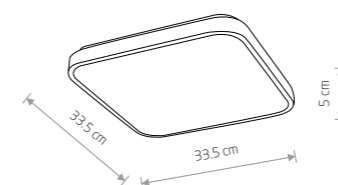

AGNES SQUARE LED

painted steel, plastic PMMA

8112 3000K 8108 3000K
8135 4000K 8138 4000K



AGNES SQUARE LED

painted steel, plastic PMMA

8113 3000K 8110 3000K
8134 4000K 8137 4000K



AGNES SQUARE LED

painted steel, plastic PMMA

8114 3000K 8111 3000K
8133 4000K 8136 4000K



Item No.	Power	Colour temp.	Luminous flux	Beam angle	Colour Rendering Index (CRI)	Input	Safety type	Ingress protection	Lifetime
8207	22W LED	3000K	1300 lm	120°	≥ 80	~220-230 V, 50/60 Hz	⊕	IP44	20000h
8204	22W LED	3000K	1200 lm	120°	≥ 80	~220-230 V, 50/60 Hz	⊕	IP44	20000h
8186	22W LED	4000K	1500 lm	120°	≥ 80	~220-230 V, 50/60 Hz	⊕	IP44	20000h
8183	22W LED	4000K	1300 lm	120°	≥ 80	~220-230 V, 50/60 Hz	⊕	IP44	20000h
8208	32W LED	3000K	2000 lm	120°	≥ 80	~220-230 V, 50/60 Hz	⊕	IP44	20000h
8205	32W LED	3000K	1700 lm	120°	≥ 80	~220-230 V, 50/60 Hz	⊕	IP44	20000h
8187	32W LED	4000K	2300 lm	120°	≥ 80	~220-230 V, 50/60 Hz	⊕	IP44	20000h
8184	32W LED	4000K	1800 lm	120°	≥ 80	~220-230 V, 50/60 Hz	⊕	IP44	20000h
8210	64W LED	3000K	4200 lm	120°	≥ 80	~220-230 V, 50/60 Hz	⊕	IP44	20000h
8206	64W LED	3000K	2700 lm	120°	≥ 80	~220-230 V, 50/60 Hz	⊕	IP44	20000h
8188	64W LED	4000K	4300 lm	120°	≥ 80	~220-230 V, 50/60 Hz	⊕	IP44	20000h
8185	64W LED	4000K	3900 lm	120°	≥ 80	~220-230 V, 50/60 Hz	⊕	IP44	20000h

Item No.	Power	Colour temp.	Luminous flux	Beam angle	Colour Rendering Index (CRI)	Input	Safety type	Ingress protection	Lifetime
8112	16W LED	3000K	970 lm	120°	≥ 80	~220-230 V, 50/60 Hz	⊕	IP44	20000h
8108	16W LED	3000K	830 lm	120°	≥ 80	~220-230 V, 50/60 Hz	⊕	IP44	20000h
8135	16W LED	4000K	1000 lm	120°	≥ 80	~220-230 V, 50/60 Hz	⊕	IP44	20000h
8138	16W LED	4000K	860 lm	120°	≥ 80	~220-230 V, 50/60 Hz	⊕	IP44	20000h
8113	32W LED	3000K	2200 lm	120°	≥ 80	~220-230 V, 50/60 Hz	⊕	IP44	20000h
8110	32W LED	3000K	1690 lm	120°	≥ 80	~220-230 V, 50/60 Hz	⊕	IP44	20000h
8134	32W LED	4000K	2300 lm	120°	≥ 80	~220-230 V, 50/60 Hz	⊕	IP44	20000h
8137	32W LED	4000K	1950 lm	120°	≥ 80	~220-230 V, 50/60 Hz	⊕	IP44	20000h
8114	64W LED	3000K	4000 lm	120°	≥ 80	~220-230 V, 50/60 Hz	⊕	IP44	20000h
8111	64W LED	3000K	3700 lm	120°	≥ 80	~220-230 V, 50/60 Hz	⊕	IP44	20000h
8133	64W LED	4000K	4000 lm	120°	≥ 80	~220-230 V, 50/60 Hz	⊕	IP44	20000h
8136	64W LED	4000K	3700 lm	120°	≥ 80	~220-230 V, 50/60 Hz	⊕	IP44	20000h

WHITE

BLACK

Can be used in the bathroom

Can be used in the bathroom

WHITE

BLACK



- Indukcyjne ładowanie smartphona (5V 1A)
- Możliwość wyboru temperatury barwowej światła w przedziałach 3000K - 6000K
- Włącznik dotykowy z funkcją ściemniania
- Port USB umożliwiający ładowanie telefonu

- Wireless charger for smartphones (5V 1 A)
- Possibility to choose the colour temperature of light in the range from 3000K to 6000K
- Touch switch with dimming function
- USB port for charging mobile phones

- Индуктивная зарядка смартфона (5 В, 1 А)
- Возможность выбора температуры света в диапазоне 3000К - 6000К
- Сенсорный переключатель с функцией затемнения
- USB-вход для зарядки телефона.

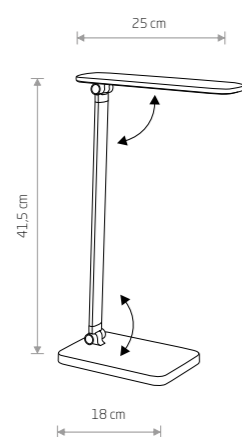

STYLE LED

painted aluminum, plastic ABS

■ 8404



Item No.	Power	Colour temp.	Luminous flux	Beam angle	Colour Rendering Index (CRI)	Input	Safety type	Power factor	Ingress protection	Lifetime
8404	10W LED	CCT CHANGE 3000-6000K	390 lm	100°	≥ 80	50/60 V, ~220-230 Hz	■	>0,5	IP20	25000h

■ BLACK





- Możliwość wyboru temperatury barwowej światła w przedziałach 3000K - 6000K
- Włącznik dotykowy z funkcją ściemniania
- Port USB umożliwiające ładowanie telefonu

- Possibility to choose the colour temperature of light in the range from 3000K to 6000K
- Touch switch with dimming function
- USB port for charging mobile phones

- Возможность выбора температуры света в диапазоне 3000K - 6000K
- Сенсорный переключатель с функцией затемнения
- USB-вход для зарядки телефона

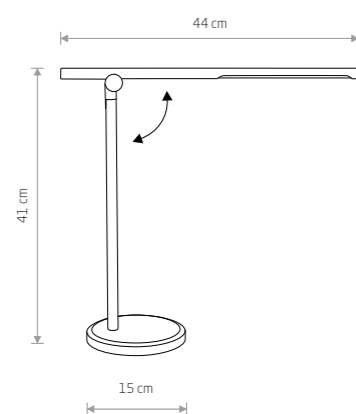

SMART LED

painted aluminum, plastic ABS

■ 8358



- Włącznik dotykowy z funkcją ściemniania
- Temperatura barwowa światła 4000K

- Touch switch with dimming function
- Colour temperature 4000K

- Сенсорный переключатель с функцией затемнения
- Цветовая температура света 4000K

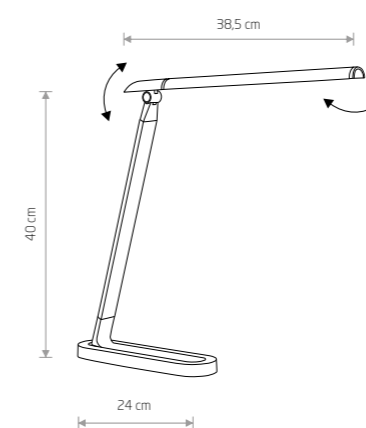

CHIC LED

painted aluminum, plastic ABS

■ 8357



Item No.	Power	Colour temp.	Luminous flux	Beam angle	Colour Rendering Index (CRI)	Input	Safety type	Power factor	Ingress protection	Lifetime
8358	8W LED	CCT CHANGE 3000-6000K	400 lm	120°	≥ 80	~220-230 V, 50/60 Hz	□	>0,5	IP20	25000h

Item No.	Power	Colour temp.	Luminous flux	Beam angle	Colour Rendering Index (CRI)	Input	Safety type	Power factor	Ingress protection	Lifetime
8357	7,5W LED	4000K	400 lm	100°	≥ 80	~220-230 V, 50/60 Hz	□	>0,5	IP20	25000h

■ BLACK ■ SILVER

■ BLACK ■ SILVER



FLEA 8203

POCATELLO 5828

POCATELLO 5828

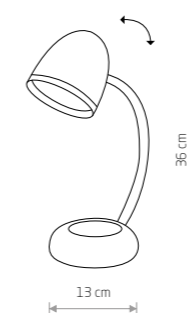

POCATELLO 5794

**POCATELLO**

painted steel, flexible stem, chrome plated steel

 5794	 5795	 5796
--	--	--

 5797	 5798	 5828
--	--	--

	 1xE27, max 18W
---	--

 WHITE	 SILVER	 GREEN	 BLUE	 PINK	 BLACK	 CHROME
---	--	---	--	--	---	--



COSMO 4917

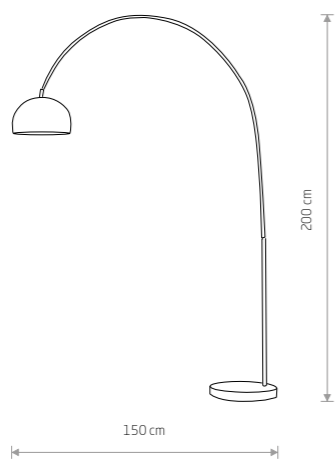

COSMO

brushed stainless steel, marble

3382

1xE27, max 60W

chrome plated steel, marble

4917

1xE27, max 60W



COSMO 3382



PUZZLE 9728

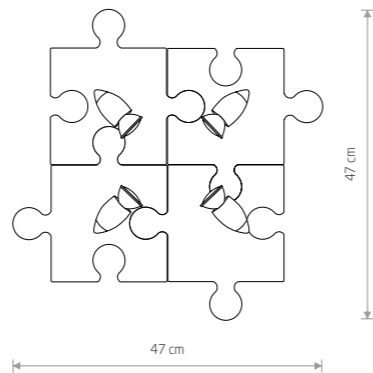

PUZZLE

plywood, plastic PA, painted steel

6384 9728

4xGU10, max 15W

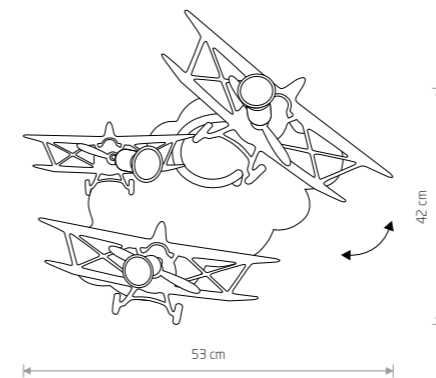
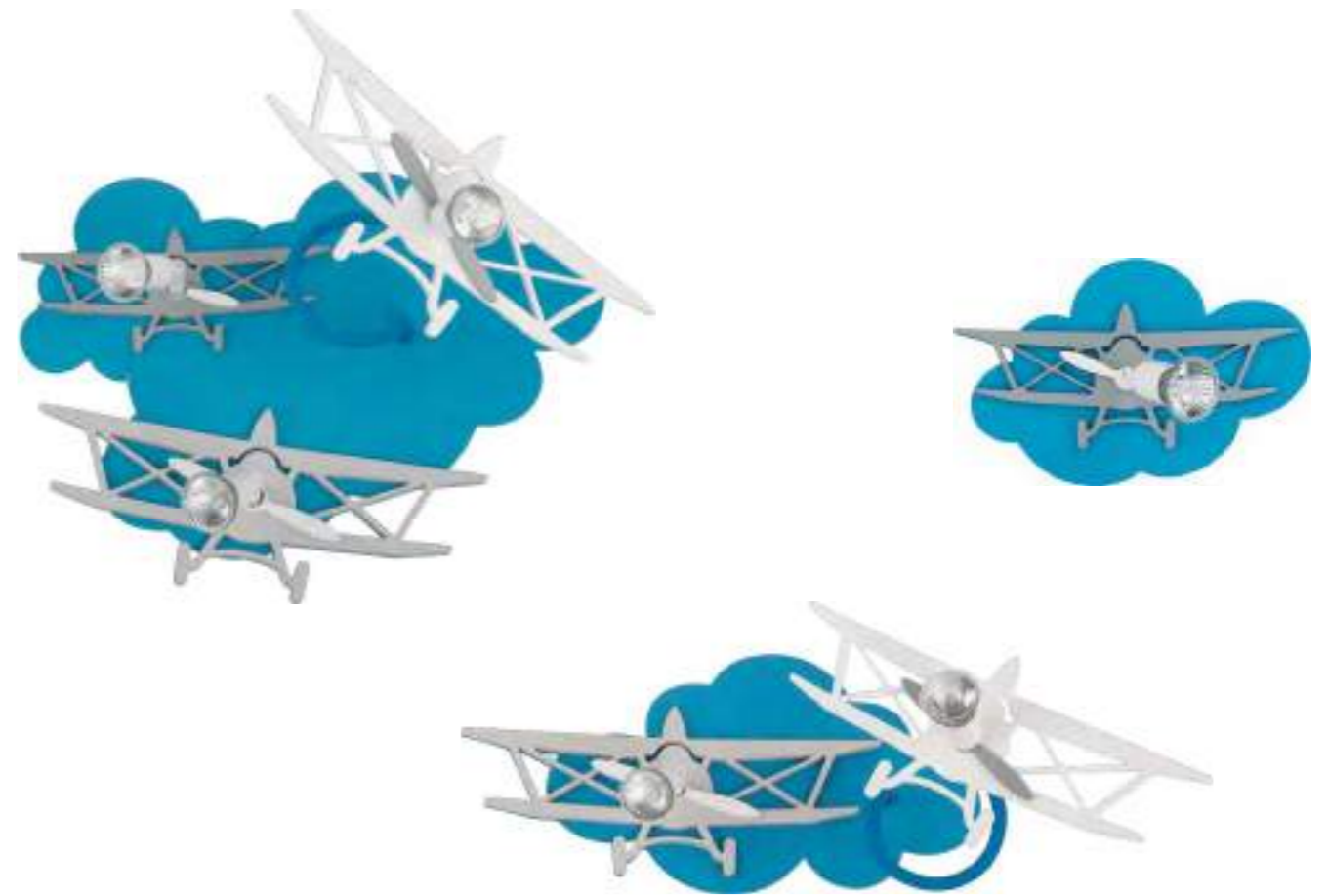

PLANE

plywood, flexible stem, painted steel

6904

3xGU10, max 35W

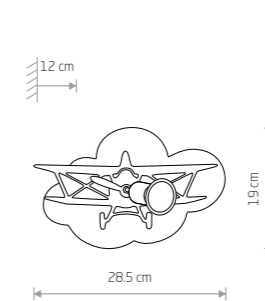

PLANE

plywood, painted steel

6902

1xGU10, max 35W

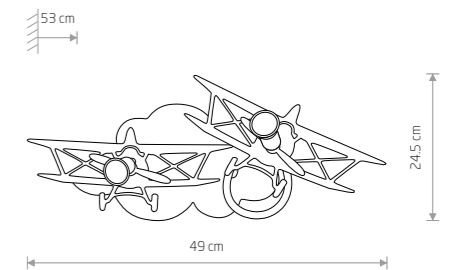

PLANE

plywood, flexible stem, painted steel

6903

2xGU10, max 35W

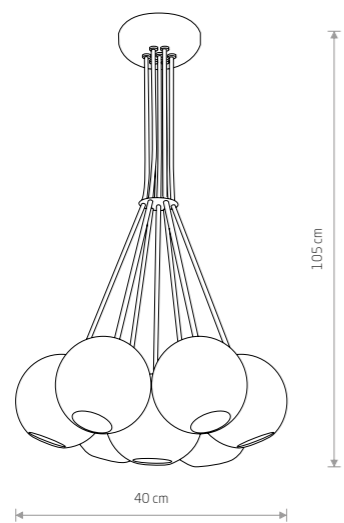

MALWI

painted steel, braided cable

 6327

 7xE27, max 35W

MALWI 6327



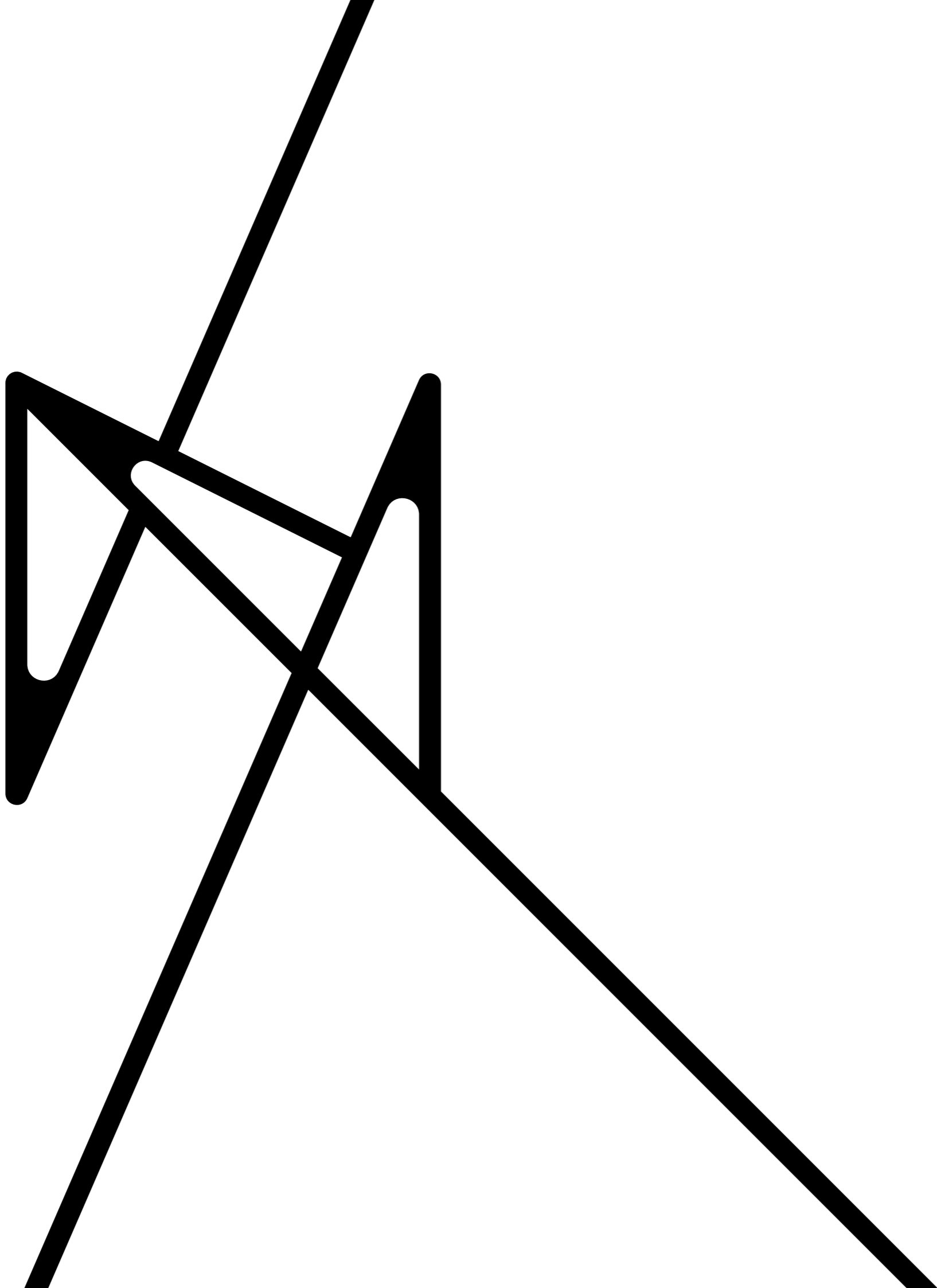

Spotlights

MONO LONG M 7674

MONO 7712

MONO 7711



MONO 7807

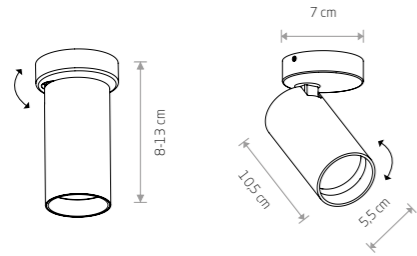

MONO

painting steel, plastic ABS

7807 7838

7771 7763

1xGU10, max 10W only LED

solid brass, painting steel, plastic ABS

7778

1xGU10, max 10W only LED



MONO 7811

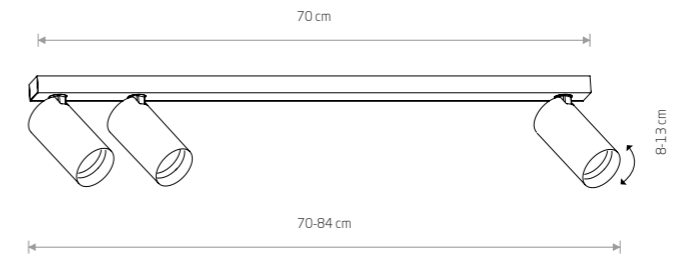

MONO

painting steel, plastic ABS

7811 7842

7775 7767

3xGU10, max 10W only LED

solid brass, painting steel, plastic ABS

7783

3xGU10, max 10W only LED



MONO 7810

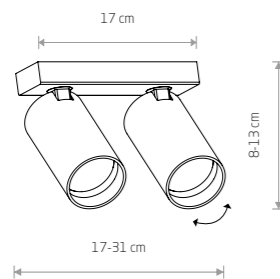

MONO

painting steel, plastic ABS

7810 7841

7774 7766

2xGU10, max 10W only LED

solid brass, painting steel, plastic ABS

7782

2xGU10, max 10W only LED



MONO 7812

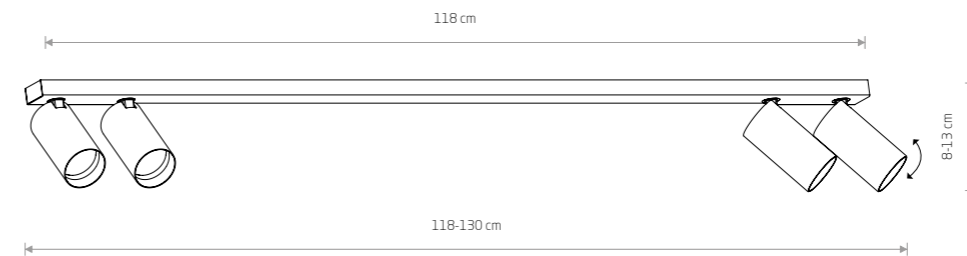

MONO

painting steel, plastic ABS

7812 7843

7776 7768

4xGU10, max 10W only LED

solid brass, painting steel, plastic ABS

7784

4xGU10, max 10W only LED

MONO 2X150 7698

MONO 7718



MONO

painting steel, plastic ABS

7813 7844

7777 7770

6xGU10, max 10W only LED

solid brass, painting steel, plastic ABS

7785

6xGU10, max 10W only LED

MONO 7770

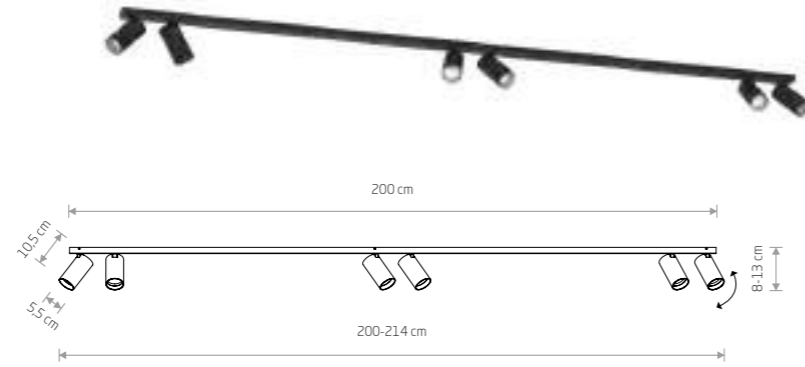

MONO CORNER 2X150 7700



MONO 2X150

painting steel, plastic ABS

7750 7720

7694 7698

6xGU10, max 10W only LED

solid brass, painting steel, plastic ABS

7754

8xGU10, max 10W only LED

MONO 2X150 7698

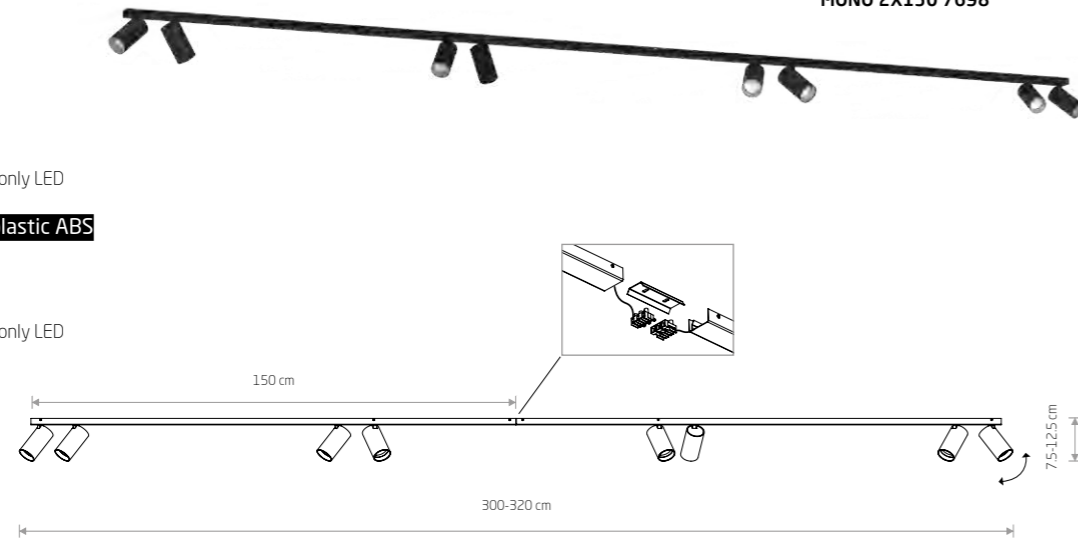

MONO CORNER 2X150

painting steel, plastic ABS

7751 7721

7695 7700

8xGU10, max 10W only LED

solid brass, painting steel, plastic ABS

7755

8xGU10, max 10W only LED

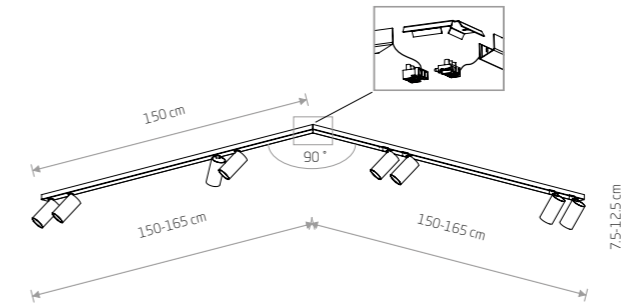

MONO 2X200 7701

MONO CORNER 2X200 7702



MONO 2X200

painting steel, plastic ABS

7752 7722

7696 7701

8xGU10, max 10W only LED

solid brass, painting steel, plastic ABS

7756

8xGU10, max 10W only LED

MONO CORNER 2X200

painting steel, plastic ABS

7753 7723

7697 7702

8xGU10, max 10W only LED

solid brass, painting steel, plastic ABS

7757

8xGU10, max 10W only LED

MONO 7838





MONO LONG S 7727

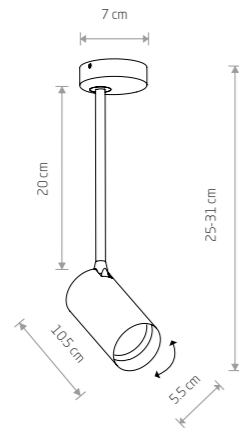

MONO LONG S

painting steel, plastic ABS

7724 7727

7670 7673

1xGU10, max 10W only LED

solid brass, painting steel, plastic ABS

7731

1xGU10, max 10W only LED

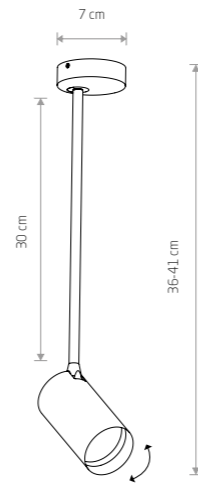

MONO LONG M

painting steel, plastic ABS

7725 7728

7671 7674

1xGU10, max 10W only LED

solid brass, painting steel, plastic ABS

7732

1xGU10, max 10W only LED



MONO LONG 7730

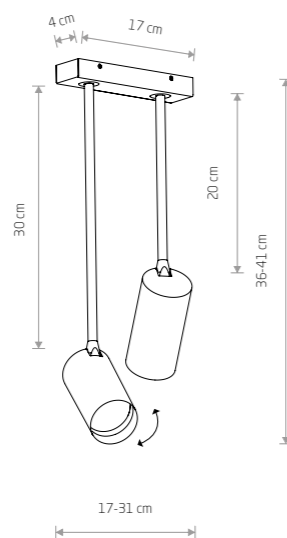

MONO LONG

painting steel, plastic ABS

7726 7730

7672 7675

2xGU10, max 10W only LED

solid brass, painting steel, plastic ABS

7733

2xGU10, max 10W only LED



MONO LONG M 7728



MONO 7764

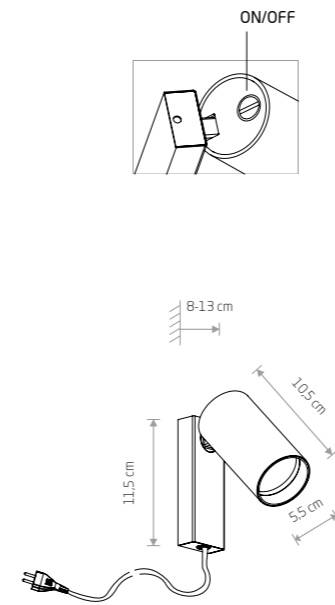

MONO 7786

MONO

painting steel, plastic ABS

7787 7786

7773 7765

1xGU10, max 10W only LED

solid brass, painting steel, plastic ABS

7781

1xGU10, max 10W only LED

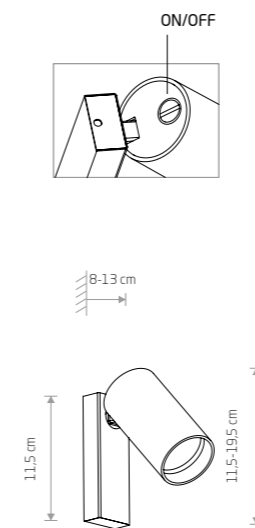

MONO 7840

MONO

painting steel, plastic ABS

7808 7840

7772 7764

1xGU10, max 10W only LED

solid brass, painting steel, plastic ABS

7780

1xGU10, max 10W only LED



MONO SURFACE 7683

MONO SURFACE

painting steel, plastic ABS

7827 7833

7683 7688

1xGU10, max 10W only LED

solid brass, painting steel, plastic ABS

7744

1xGU10, max 10W only LED

cut out \varnothing 35 mm

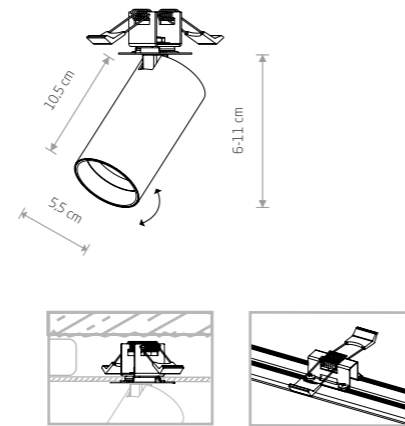

MONO SURFACE 7684

MONO SURFACE

painting steel, plastic ABS

7828 7834

7684 7690

2xGU10, max 10W only LED

solid brass, painting steel, plastic ABS

7745

2xGU10, max 10W only LED

cut out 160x31 mm

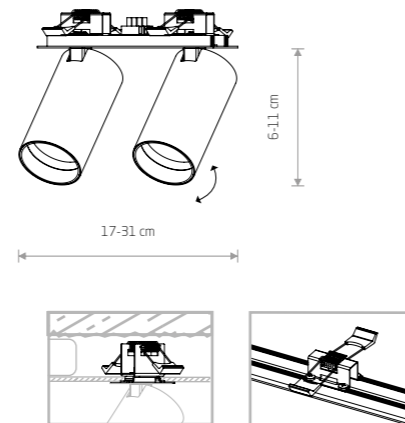

MONO SURFACE 7834

MONO SURFACE 7833





MONO SURFACE 7685

MONO SURFACE 7687



MONO SURFACE 7685

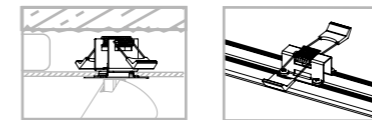
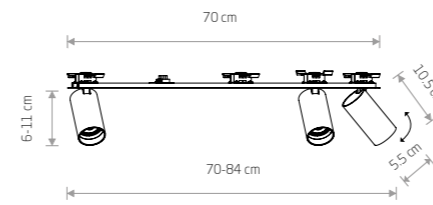

MONO SURFACE 7686

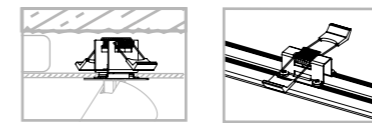
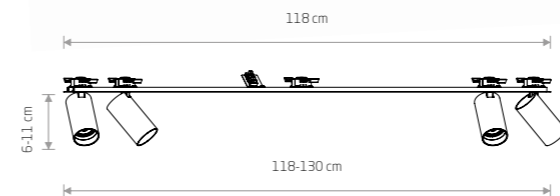

MONO SURFACE 7687

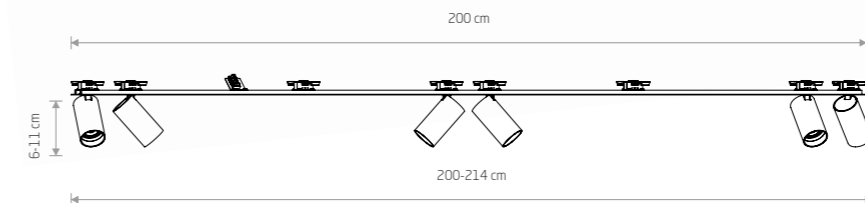

MONO SURFACE

painting steel, plastic ABS

7830 7835

7685 7691

3xGU10, max 10W only LED

solid brass, painting steel, plastic ABS

7746

3xGU10, max 10W only LED

cut out 690x31 mm

MONO SURFACE

painting steel, plastic ABS

7831 7836

7686 7692

4xGU10, max 10W only LED

solid brass, painting steel, plastic ABS

7747

4xGU10, max 10W only LED

cut out 1170x31 mm

MONO SURFACE

painting steel, plastic ABS

7832 7837

7687 7693

6xGU10, max 10W only LED

solid brass, painting steel, plastic ABS

7748

6xGU10, max 10W only LED

cut out 1990x31 mm

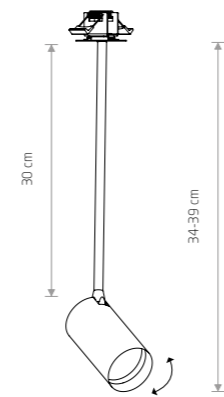
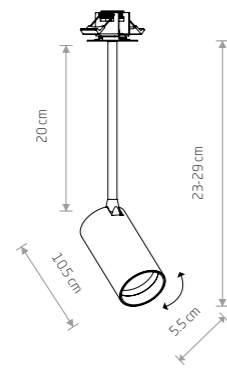
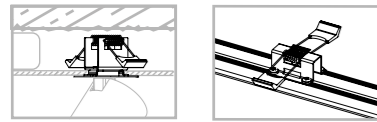

MONO SURFACE LONG S 7680

MONO SURFACE LONG S

painting steel, plastic ABS

7734 7737

7676 7680

1xGU10, max 10W only LED

solid brass, painting steel, plastic ABS

7741

1xGU10, max 10W only LED

cut out \varnothing 35 mm

MONO SURFACE LONG M

painting steel, plastic ABS

7735 7738

7677 7681

1xGU10, max 10W only LED

solid brass, painting steel, plastic ABS

7742

1xGU10, max 10W only LED

cut out \varnothing 35 mm

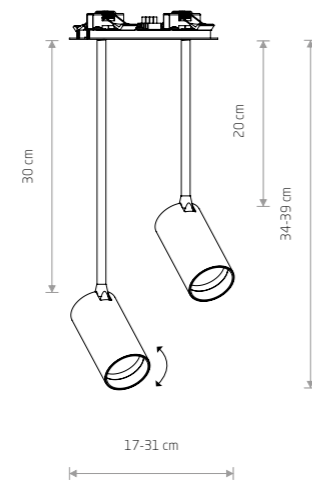
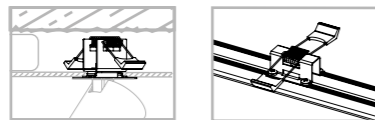

MONO SURFACE LONG

painting steel, plastic ABS

7736 7740

7678 7682

2xGU10, max 10W only LED

solid brass, painting steel, plastic ABS

7743

2xGU10, max 10W only LED

cut out 160x31 mm



MONO SURFACE LONG 7682

MONO SURFACE LONG M 7742



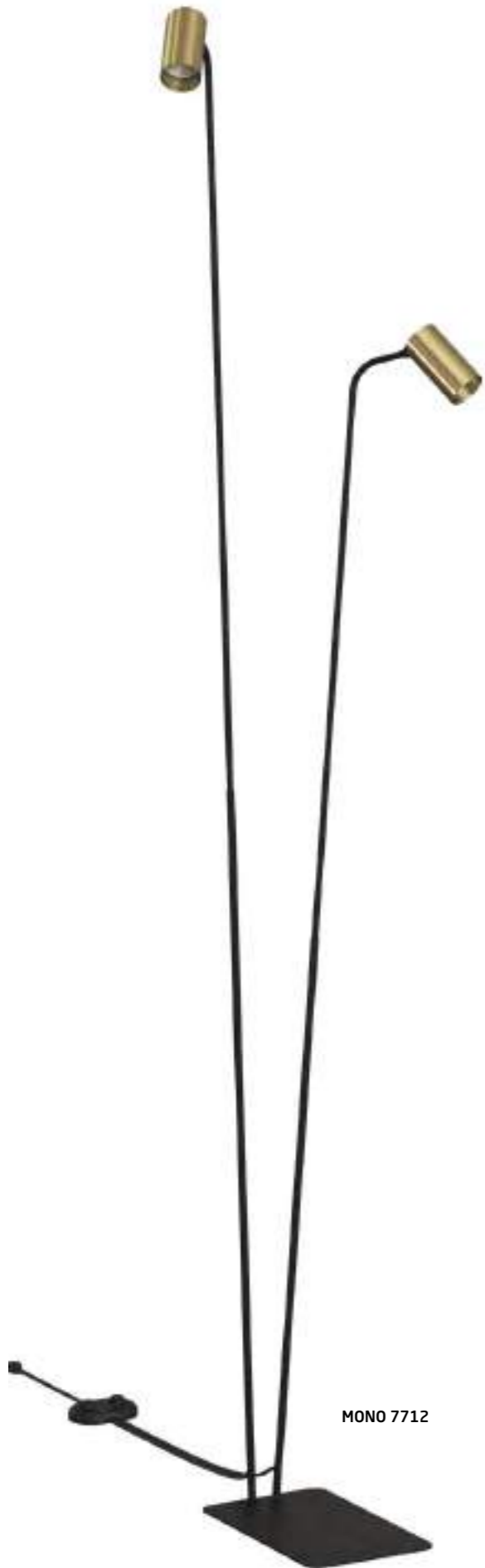

MONO 7712

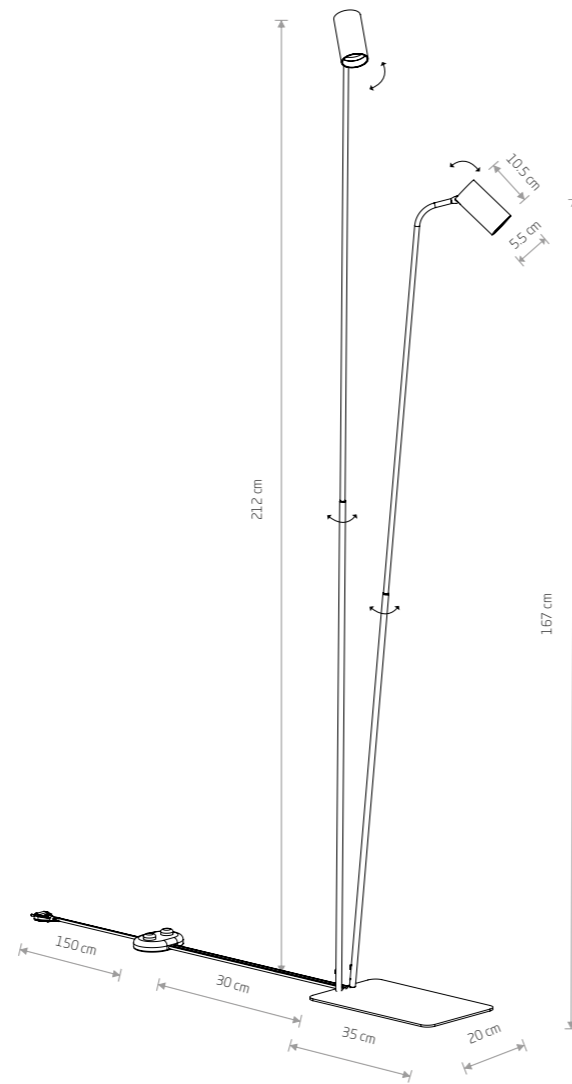

MONO

painting steel, plastic ABS

7705 7708

7715 7718

2xGU10, max 10W only LED

solid brass, painting steel, plastic ABS

7712

2xGU10, max 10W only LED

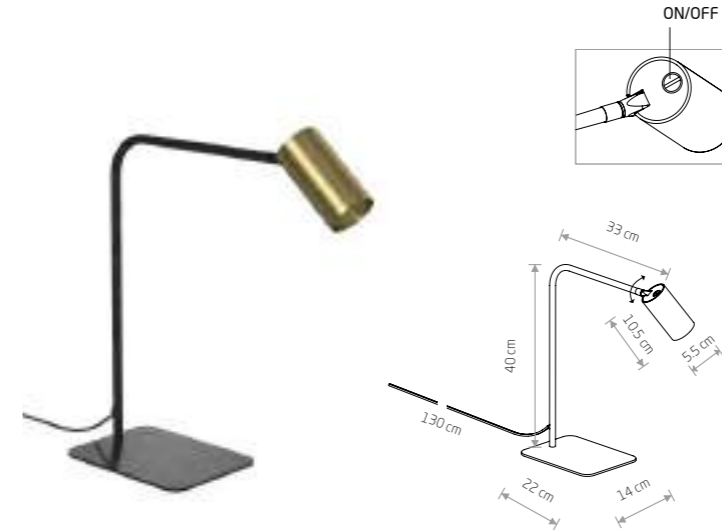

MONO 7710

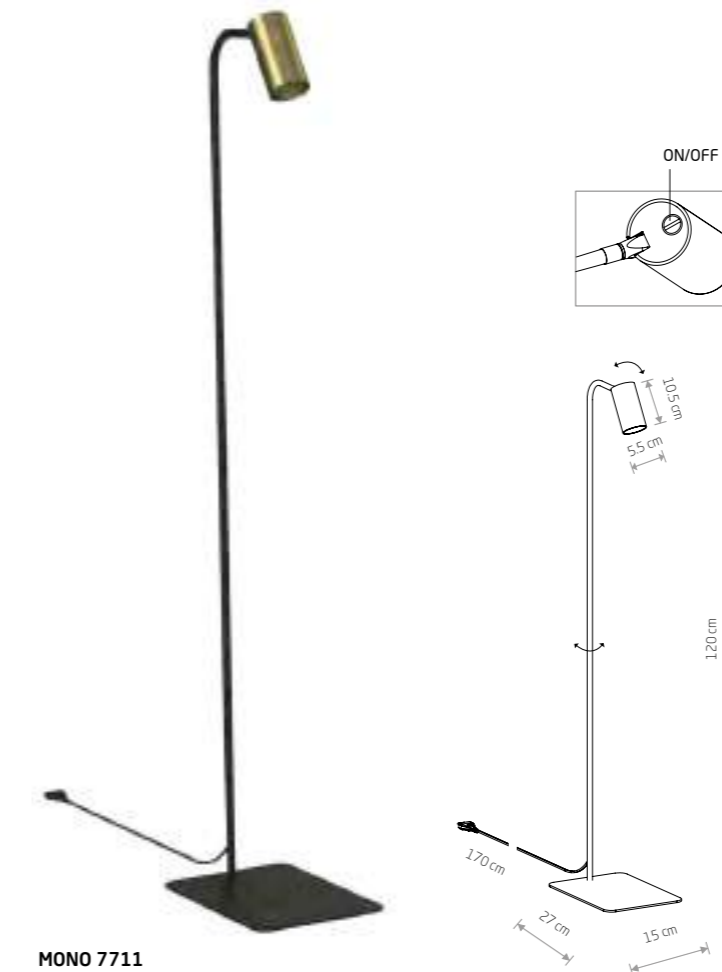

MONO 7711

MONO

painting steel, plastic ABS

7703 7706

7713 7716

1xGU10, max 10W only LED

solid brass, painting steel, plastic ABS

7710

1xGU10, max 10W only LED

MONO

painting steel, plastic ABS

7704 7707

7714 7717

1xGU10, max 10W only LED

solid brass, painting steel, plastic ABS

7711

1xGU10, max 10W only LED

EYE SPOT 6018

EYE SPOT 6611



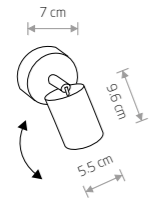

EYE SPOT 6018

EYE SPOT

Painted steel, chrome

6014 6134

6138 6018

1xGU10, max 10W only LED

Painted steel, solid brass

8816

1xGU10, max 10W only LED



EYE SPOT 8817

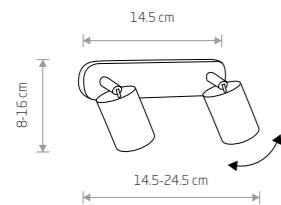

EYE SPOT

Painted steel, chrome

6015 6135

6140 6020

2xGU10, max 10W only LED

Painted steel, solid brass

8817

2xGU10, max 10W only LED



EYE SPOT 6611

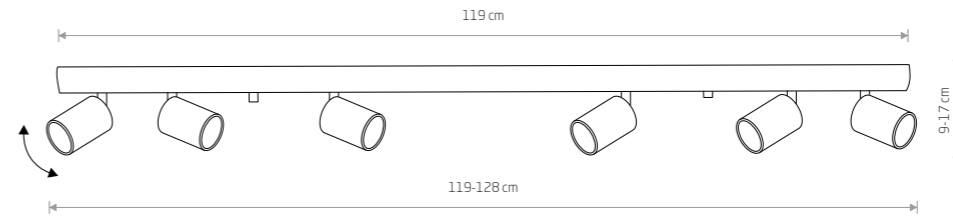

EYE SPOT

Painted steel, chrome

6607 6610

6608 6611

6xGU10, max 10W only LED

Painted steel, solid brass

8819

6xGU10, max 10W only LED



EYE SPOT 6136

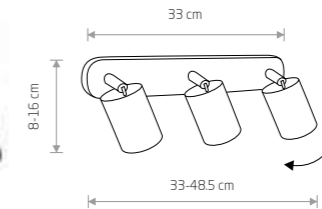

EYE SPOT

Painted steel, chrome

6016 6136

6141 6021

3xGU10, max 10W only LED

Painted steel, solid brass

8818

3xGU10, max 10W only LED



EYE SPOT 8820

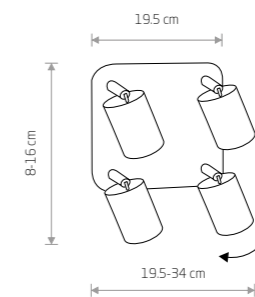

EYE SPOT

Painted steel, chrome

6017 6137

5844 6022

4xGU10, max 10W only LED

Painted steel, solid brass

8820

4xGU10, max 10W only LED



EYE FIT 9400



EYE FIT 9395

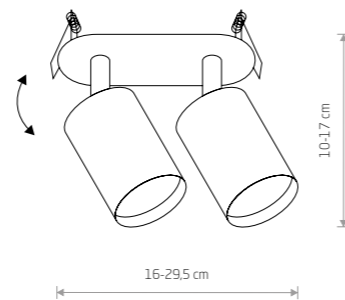
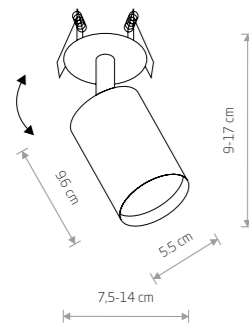

EYE FIT

painted steel, chrome

9396 9400

1xGU10, max 10W only LED

cut out Ø 60 mm

EYE FIT

painted steel, chrome

9395 9398

2xGU10, max 10W only LED

cut out 115x45 mm



IRIS LED 8994



IRIS LED 8994

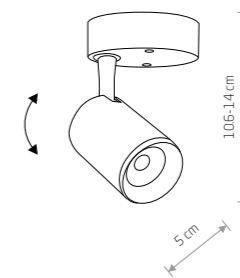

IRIS LED

painted aluminum, plastic

8993 8994

Item No.	Power	Colour temp.	Luminous flux	Beam angle	Colour Rendering Index (CRI)	Input	Safety type	Power factor	Ingress protection	Lifetime
8993	7W LED	3000K	480 lm	30 °	≥ 80	~220-230 V, 50/60 Hz	☐	>0,5	IP20	30000h
8994	7W LED	3000K	430 lm	30 °	≥ 80	~220-230 V, 50/60 Hz	☐	>0,5	IP20	30000h



CROSS 9604



VESPA 9593



VESPA 8838



CROSS 9596



CROSS 9603



IRIS LED 9592

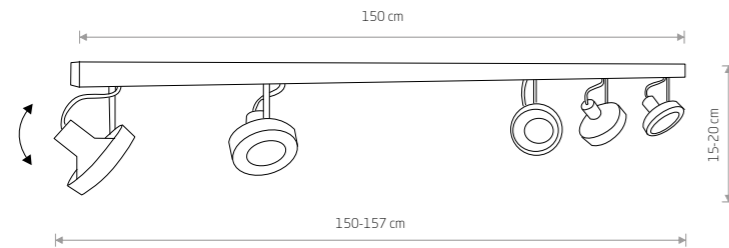

CROSS

■ painted steel, chrome

■ 9604 ■ 9600

● 5xGU10 ES111, max 75W

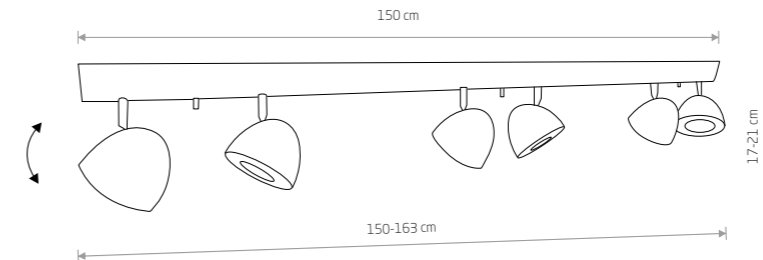

VESPA

■ painted steel, chrome

■ 9595 ■ 8842

● 6xGU10 ES111, max 75W

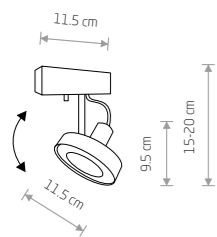

CROSS

■ painted steel, chrome

■ 9603 ■ 9598

● 1xGU10 ES111, max 75W

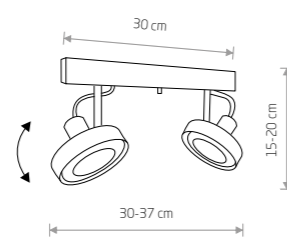

CROSS

■ painted steel, chrome

■ 9602 ■ 9597

● 2xGU10 ES111, max 75W

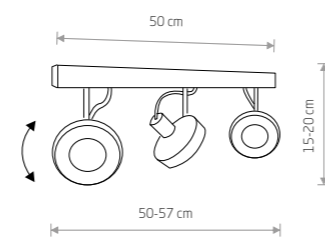

CROSS

■ painted steel, chrome

■ 9601 ■ 9596

● 3xGU10 ES111, max 75W

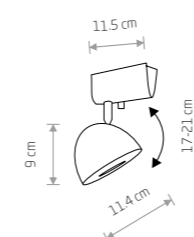

VESPA

■ painted steel, chrome

■ 9594 ■ 8838

● 1xGU10 ES111, max 75W

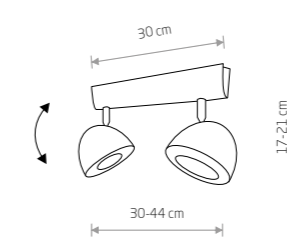

VESPA

■ painted steel, chrome

■ 9593 ■ 8840

● 2xGU10 ES111, max 75W

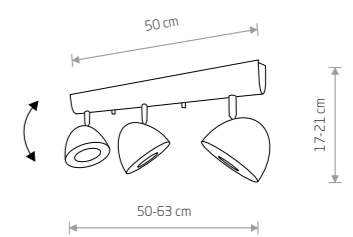

VESPA

■ painted steel, chrome

■ 9592 ■ 8841

● 3xGU10 ES111, max 75W

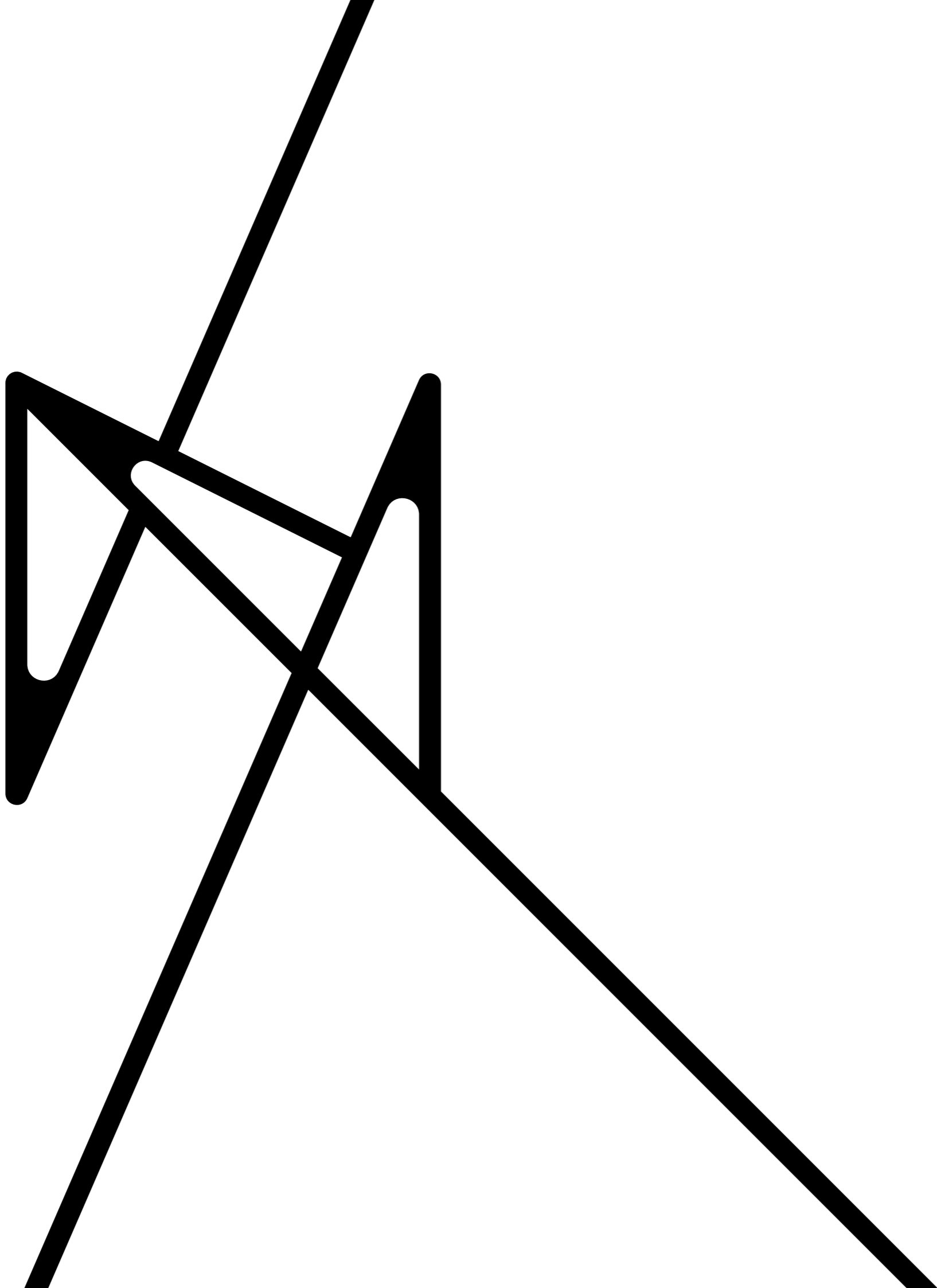

Downlights

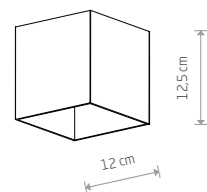

COBBLE
painted aluminum

7791 7790

1xGU10 ES111, max 75W

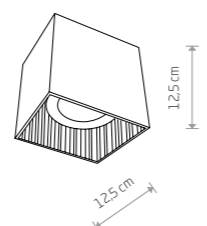

GROOVE
painted aluminum

7793 7792

1xGU10 ES111, max 75W

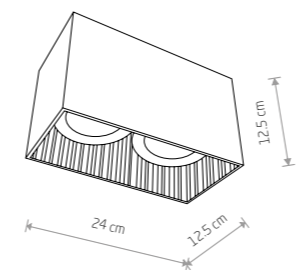

GROOVE
painted aluminum

9383 9316

2xGU10 ES111, max 75W

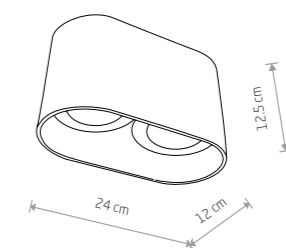

OVAL
painted aluminum

9241 9240

2xGU10 ES111, max 75W

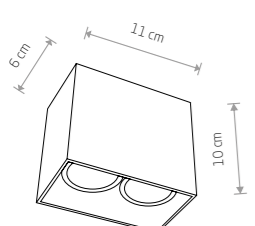

GAP
painted aluminum

9385 9384

2xGU10, max 35W

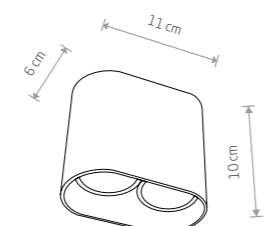

PAG
painted aluminum

9387 9386

2xGU10, max 35W



HALO 8196

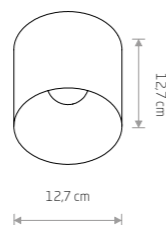

HALO
painted steel, plastic ABS

8195 8196

1xGU10, max 10W only LED

WHITE P004 RAL 9003 BLACK P013 RAL 9005



FLEA 8202



POINT TONE 8222



INDIA 7858



MIKE 7660



FLEA 8203



POINT TONE 8225



INDIA 7860



MIKE 7658

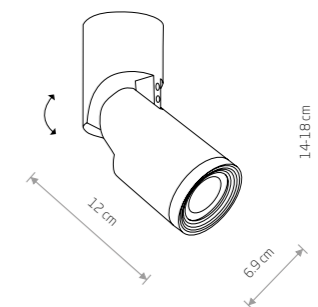
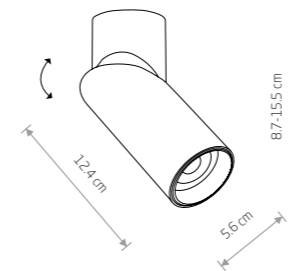
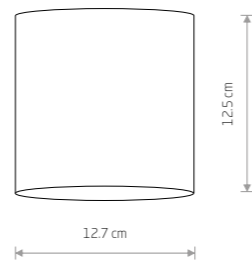
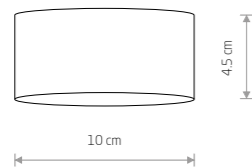

FLEA

painting steel

- 8202
- 8203

1xGX53, max 12W

POINT TONE

painting steel, plastic ABS

- 8220
- 8221
- 8222

8225
- 8224
- 8223

1xGU10, max 10W only LED

INDIA

painting aluminum

- 7858
- 7860

1xGU10, max 15W

MIKE

painting aluminum

- 7660
- 7658

1xGU10, max 15W

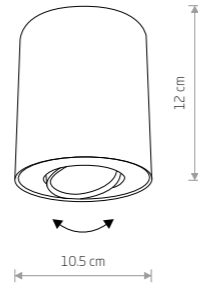

SET
painted steel

- 8900 8895
- 1xGU10, max 10W only LED

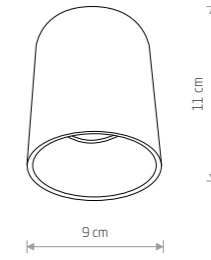

EYE TONE
painted steel, plastic ABS

- 8932 8928
- 1xGU10, max 10W only LED

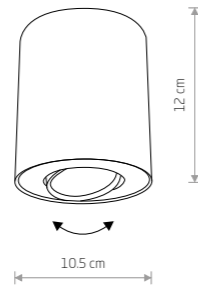

SET
painted steel, painted aluminum

- 8902 8897
- 1xGU10, max 10W only LED

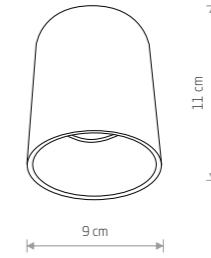

EYE TONE
painted steel, plastic ABS

- 8931 8926
- 1xGU10, max 10W only LED

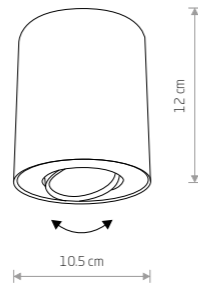

SET
painted steel

- 8901 8896
- 1xGU10, max 10W only LED

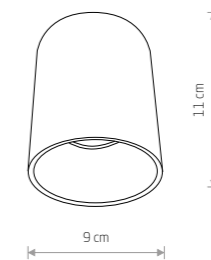

EYE TONE
painted steel, plastic ABS

- 8930 8925
- 1xGU10, max 10W only LED



EYE TONE 8087

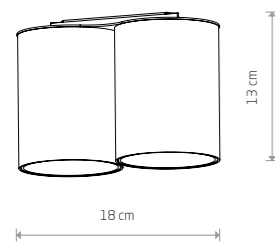

EYE TONE

painted steel, plastic ABS

■ 8086 ■ 8087

■ 8088 ■ 7665

● 2xGU10, max 10W only LED



EYE TONE 8093

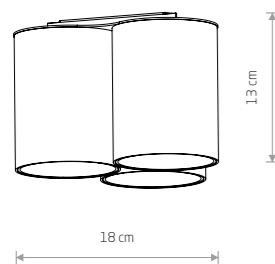

EYE TONE

painted steel, plastic ABS

■ 8091 ■ 8092

■ 8093 ■ 7666

● 3xGU10, max 10W only LED

■ BLACK P013 RAL 9005 ■ WHITE P004 RAL 9003 ■ GOLD P021



EYE TONE 7666

POINT PLEXI M 6526



POINT PLEXI L 6528



POINT S 7603

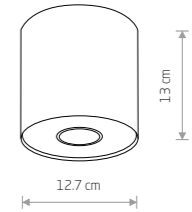

POINT M
painted steel

7602
1xGU10, max 35W

POINT PLEXI M

painted steel, plastic PMMA

6525 6527 6526
1xGU10, max 10W only LED

POINT PLEXI L

painted steel, plastic PMMA

6528 6530
1xE27, max 20W

POINT M 6001

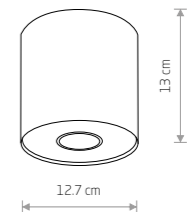

POINT M
painted steel

6001
1xGU10, max 35W

BIT S 9486



BIT M 9481

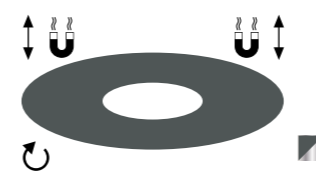

POINT S
painted steel

6000
1xGU10, max 35W

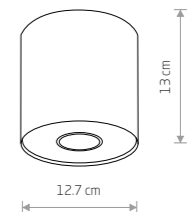

POINT M
painted steel

6007
1xGU10, max 35W

BIT S

painted steel

9482 9486
1xGU10 ES111, max 75W

BIT M

painted steel

9481 9485
1xGU10 ES111, max 75W

POINT M 6007



POINT S
painted steel

6006
1xGU10, max 35W

DALE 7613



DALE 7612

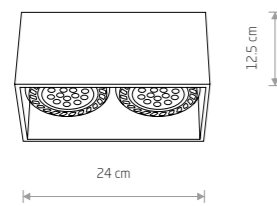

DALE
plywood

7613

2xGU10 ES111, max 15W

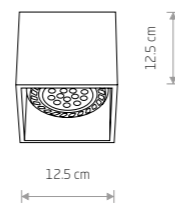

DALE
plywood

7612

1xGU10 ES111, max 15W

DOWNLIGHT ES111 9575

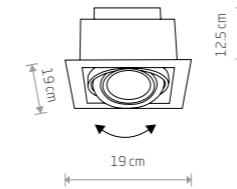

DOWNLIGHT ES111
painted steel

9571 9575

1xGU10 ES111, max 15W

cut out 165x165 mm

DOWNLIGHT ES111 9570

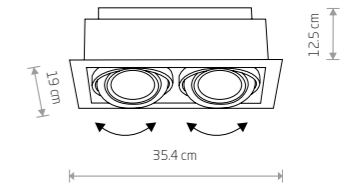

DOWNLIGHT ES111
painted steel

9570 9574

2xGU10 ES111, max 15W

cut out 320x165 mm

BOX ES111 9495

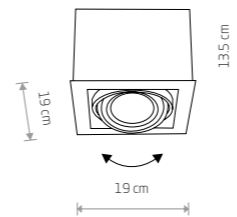

BOX ES111
plywood, painted steel

9495 9497 7648

1xGU10 ES111, max 15W

BOX ES111 7650

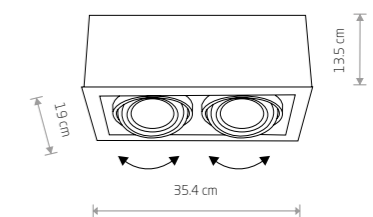

BOX ES111
plywood, painted steel

9470 9472 7650

2xGU10 ES111, max 15W



MOD 9412



MOD 9412

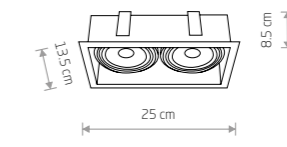
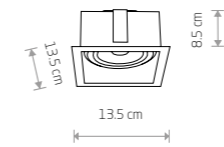

MOD

painted steel

- 9417
- 9413

1xGU10 ES111, max 75W

cut out 120x120 mm

MOD

painted steel

- 9416
- 9412

2xGU10 ES111, max 75W

cut out 230x120 mm



MOD PLUS 9404

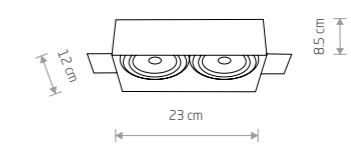
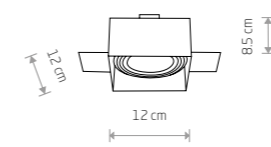

MOD PLUS

painted steel

- 9404
- 9408

1xGU10 ES111, max 75W

cut out 120x120 mm

MOD PLUS

painted steel

- 9403
- 9407

2xGU10 ES111, max 75W

cut out 230x120 mm



EYE MOD 8937

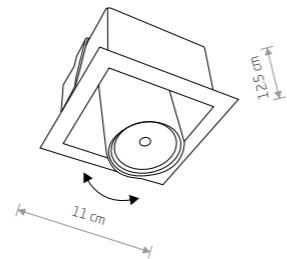

EYE MOD

painted steel

8936 8937

1xGU10, max 35W

cut out 95×90 mm



EYE MOD 8938

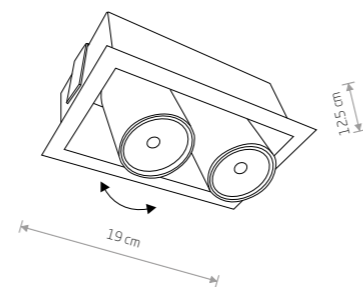

EYE MOD

painted steel

8938 8940

2xGU10, max 35W

cut out 175×90 mm



DOT 9378

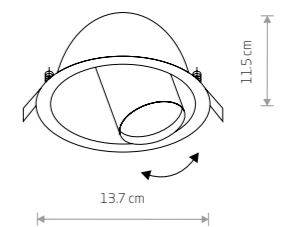

DOT

painted steel

9378 8826

1xGU10, max 35W

cut out ø 110 mm



CL KOS LED 24W 8775

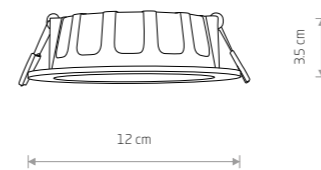

CL KOS LED 8W

plastic

8782 3000K 8781 4000K

cut out ø 100 mm

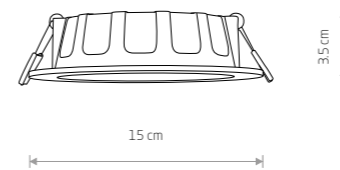

CL KOS LED 10W

plastic

8780 3000K 8778 4000K

cut out ø 125 mm

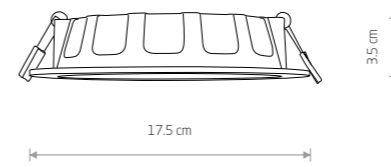

CL KOS LED 16W

plastic

8777 3000K 8776 4000K

cut out ø 150 mm

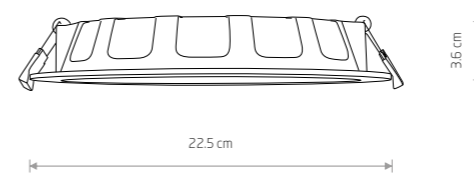

CL KOS LED 24W

plastic

8775 3000K 8774 4000K

cut out ø 200 mm

Item No.	Power	Colour temp.	Luminous flux	Beam angle	Colour Rendering Index (CRI)	Ingress protection	LED brand	Driver brand	Lifetime	Warranty
8782	8W LED	3000K	550 lm	100°	≥ 80	IP44	Sanan	Driver on board	50000h	5 years
8781	8W LED	4000K	680 lm	100°	≥ 80	IP44	Sanan	Driver on board	50000h	5 years
8780	10W LED	3000K	850 lm	100°	≥ 80	IP44	Sanan	Driver on board	50000h	5 years
8778	10W LED	4000K	880 lm	100°	≥ 80	IP44	Sanan	Driver on board	50000h	5 years
8777	16W LED	3000K	1450 lm	100°	≥ 80	IP44	Sanan	Driver on board	50000h	5 years
8776	16W LED	4000K	1450 lm	100°	≥ 80	IP44	Sanan	Driver on board	50000h	5 years
8775	24W LED	3000K	2200 lm	100°	≥ 80	IP44	Sanan	Driver on board	50000h	5 years
8774	24W LED	4000K	2200 lm	100°	≥ 80	IP44	Sanan	Driver on board	50000h	5 years

Can be used in the bathroom

WHITE

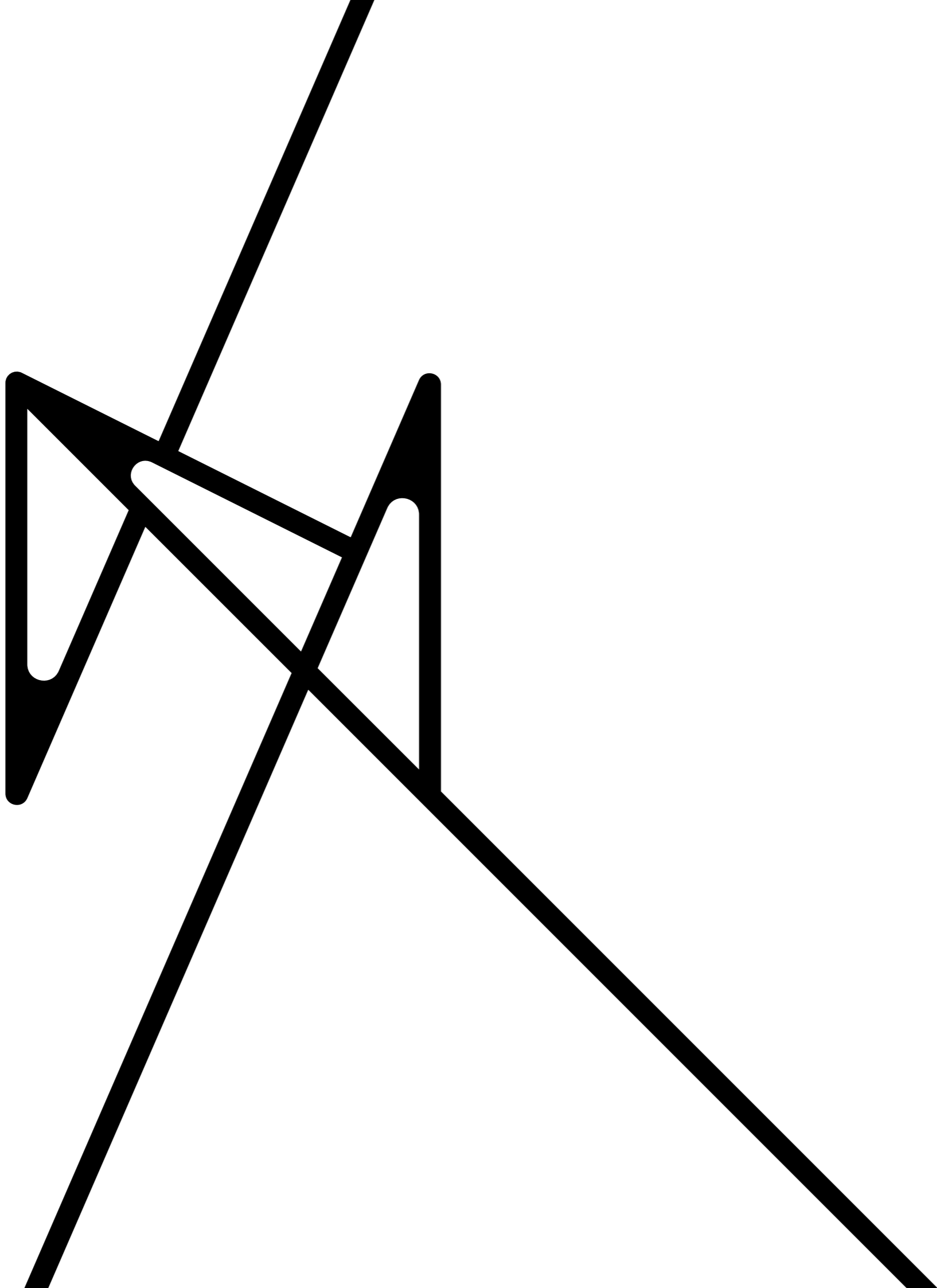

Profile
track light system

PROFILE IRIS LED 12W 9000





PROFILE IRIS LED 7W 8996

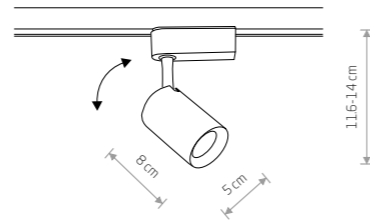

PROFILE IRIS LED 7W

Painted aluminum, plastic PC

8995 3000K 8996 3000K

8997 4000K 8998 4000K



PROFILE IRIS LED 12W 9002

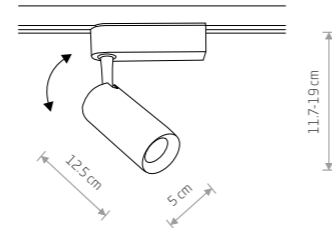

PROFILE IRIS LED 12W

Painted aluminum, plastic PC

9000 3000K 9001 3000K

9002 4000K 9003 4000K



PROFILE IRIS LED 20W 9005

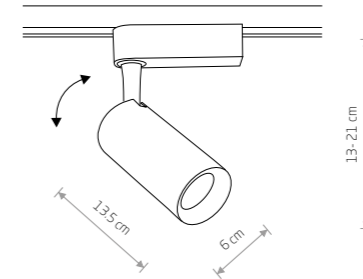

PROFILE IRIS LED 20W

Painted aluminum, plastic PC

9004 3000K 9005 3000K

9006 4000K 9007 4000K



Item No.	Power	Colour temp.	Luminous flux	Beam angle	Colour Rendering Index (CRI)	Input	Safety type	Power factor	Ingress protection	Lifetime
8995	7W LED	3000K	480 lm	30°	80	~220-230 V, 50/60 Hz	☐	>0,5	IP20	30000h
8996	7W LED	3000K	430 lm	30°	80	~220-230 V, 50/60 Hz	☐	>0,5	IP20	30000h
8997	7W LED	4000K	530 lm	30°	80	~220-230 V, 50/60 Hz	☐	>0,5	IP20	30000h
8998	7W LED	4000K	480 lm	30°	80	~220-230 V, 50/60 Hz	☐	>0,5	IP20	30000h
9000	12W LED	3000K	800 lm	30°	80	~220-230 V, 50/60 Hz	☐	>0,5	IP20	30000h
9001	12W LED	3000K	720 lm	30°	80	~220-230 V, 50/60 Hz	☐	>0,5	IP20	30000h
9002	12W LED	4000K	850 lm	30°	80	~220-230 V, 50/60 Hz	☐	>0,5	IP20	30000h
9003	12W LED	4000K	800 lm	30°	80	~220-230 V, 50/60 Hz	☐	>0,5	IP20	30000h

Item No.	Power	Colour temp.	Luminous flux	Beam angle	Colour Rendering Index (CRI)	Input	Safety type	Power factor	Ingress protection	Lifetime
9004	20W LED	3000K	1320 lm	30°	80	~220-230 V, 50/60 Hz	☐	>0,5	IP20	30000h
9005	20W LED	3000K	1230 lm	30°	80	~220-230 V, 50/60 Hz	☐	>0,5	IP20	30000h
9006	20W LED	4000K	1450 lm	30°	80	~220-230 V, 50/60 Hz	☐	>0,5	IP20	30000h
9007	20W LED	4000K	1320 lm	30°	80	~220-230 V, 50/60 Hz	☐	>0,5	IP20	30000h



PROFILE STORE PRO LED 7 W 8318

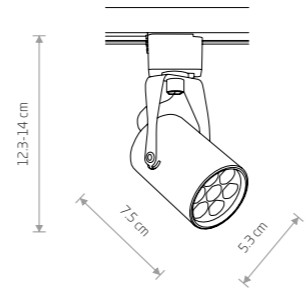

PROFILE STORE PRO LED 7W

Painted aluminum, plastic

- 8316 3000K 8318 3000K
- 8315 4000K 8317 4000K



PROFILE STORE PRO LED 18W 8326

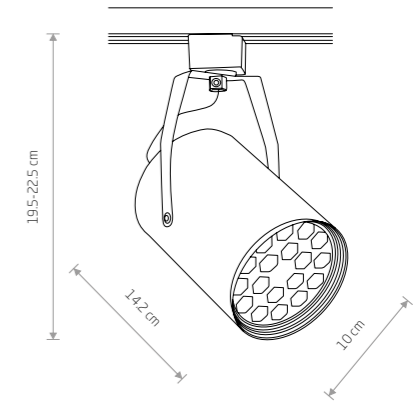

PROFILE STORE PRO LED 18W

Painted aluminum, plastic

- 8325 3000K 8327 3000K
- 8324 4000K 8326 4000K



PROFILE STORE PRO LED 12W 8323

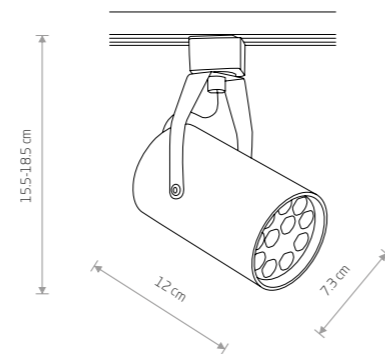

PROFILE STORE PRO LED 12W

Painted aluminum, plastic

- 8321 3000K 8323 3000K
- 8320 4000K 8322 4000K



Item No.	Power	Colour temp.	Luminous flux	Beam angle	Colour Rendering Index (CRI)	Input	Safety type	Power factor	Ingress protection	Lifetime
8315	7W LED	4000K	680 lm	24°	≥ 80	~220-230 V, 50/60 Hz	☐	>0,5	IP20	30000h
8316	7W LED	3000K	630 lm	24°	≥ 80	~220-230 V, 50/60 Hz	☐	>0,5	IP20	30000h
8317	7W LED	4000K	560 lm	24°	≥ 80	~220-230 V, 50/60 Hz	☐	>0,5	IP20	30000h
8318	7W LED	3000K	600 lm	24°	≥ 80	~220-230 V, 50/60 Hz	☐	>0,5	IP20	30000h
8320	12W LED	4000K	1100 lm	24°	≥ 80	~220-230 V, 50/60 Hz	☐	>0,5	IP20	30000h
8321	12W LED	3000K	1000 lm	24°	≥ 80	~220-230 V, 50/60 Hz	☐	>0,5	IP20	30000h
8322	12W LED	4000K	960 lm	24°	≥ 80	~220-230 V, 50/60 Hz	☐	>0,5	IP20	30000h
8323	12W LED	3000K	930 lm	24°	≥ 80	~220-230 V, 50/60 Hz	☐	>0,5	IP20	30000h
8324	18W LED	4000K	1700 lm	24°	≥ 80	~220-230 V, 50/60 Hz	☐	>0,5	IP20	30000h
8325	18W LED	3000K	1440 lm	24°	≥ 80	~220-230 V, 50/60 Hz	☐	>0,5	IP20	30000h
8326	18W LED	4000K	1700 lm	24°	≥ 80	~220-230 V, 50/60 Hz	☐	>0,5	IP20	30000h
8327	18W LED	3000K	1600 lm	24°	≥ 80	~220-230 V, 50/60 Hz	☐	>0,5	IP20	30000h



PROFILE MIKE 7661

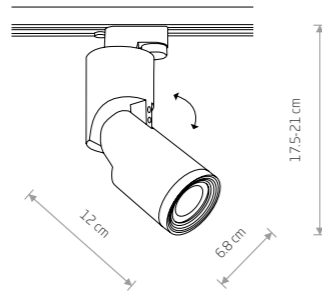

PROFILE MIKE

Painted aluminum, plastic

7662 7661

1xGU10, max 15W



PROFILE ZOOM LED 7625



PROFILE INDIA 7657

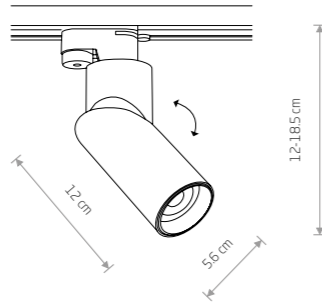

PROFILE INDIA

Painted aluminum, plastic

7656 7657

1xGU10, max 15W

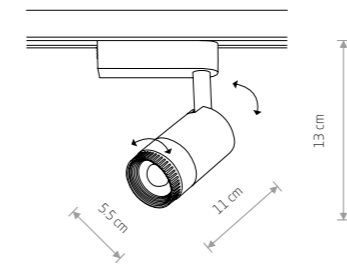

PROFILE ZOOM LED

Painted aluminum, plastic

7623 3000K 7625 3000K

7624 4000K 7626 4000K



BEAM CONE

BEAM ANGLE 15°



BEAM ANGLE 50°



PROFILE FOKUS 7621

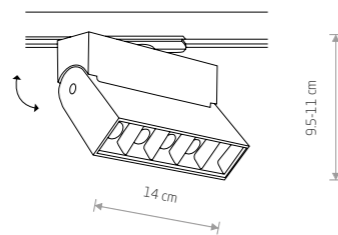

PROFILE FOCUS LED

Painted aluminum, plastic

7618 3000K 7621 3000K

7620 4000K 7622 4000K



Item No.	Power	Colour temp.	Luminous flux	Beam angle	Colour Rendering Index (CRI)	Input	Safety type	Power factor	Ingress protection
7618	9W LED	3000K	440 lm	36°	>90	220-230 V, 50/60 Hz	□	>0.9	IP20
7620	9W LED	4000K	480 lm	36°	>90	220-230 V, 50/60 Hz	□	>0.9	IP20
7621	9W LED	3000K	430 lm	36°	>0.9	220-230 V, 50/60 Hz	□	>0.9	IP20
7622	9W LED	4000K	460 lm	36°	>90	220-230 V, 50/60 Hz	□	>0.9	IP20
7623	9W LED	3000K	550 lm	15-50°	>90	220-230 V, 50/60 Hz	□	>0.9	IP20
7624	9W LED	4000K	580 lm	15-50°	>90	220-230 V, 50/60 Hz	□	>0.9	IP20
7625	9W LED	3000K	490 lm	15-50°	>90	220-230 V, 50/60 Hz	□	>0.9	IP20
7626	9W LED	4000K	520 lm	15-50°	>90	220-230 V, 50/60 Hz	□	>0.9	IP20



PROFILE EYE SPOT 9322

PROFILE EYE 9338



PROFILE EYE SUPER C 9244

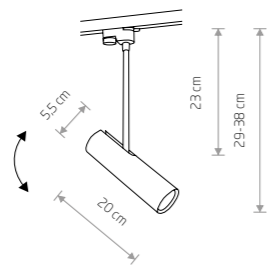

PROFILE EYE SUPER C
 painted steel, plastic PC

- 9245 9244
- ● 1xGU10, max 35W

PROFILE EYE
 painted steel, plastic PC

- 9337 9338
- ● 1xGU10, max 10W only LED

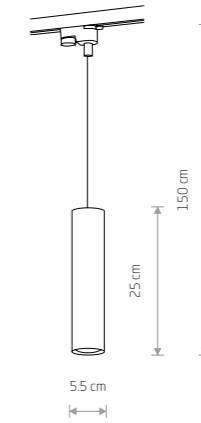

PROFILE EYE 9338



PROFILE EYE SUPER A 9325

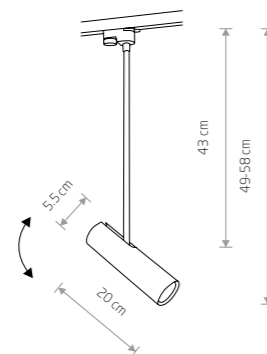

PROFILE EYE SUPER A
 painted steel, plastic PC

- 9324 9325
- ● 1xGU10, max 35W

PROFILE BIT
 painted steel, plastic PC

- 8823
- ● 1xGU10 ES111, max 75W

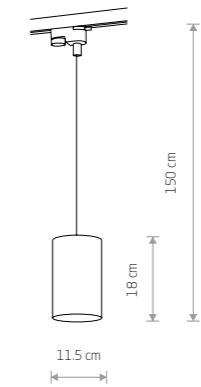

PROFILE BIT 8823



PROFILE EYE FLEX 9332

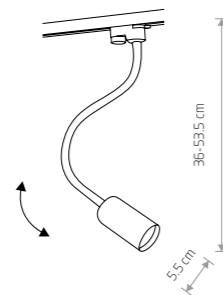

PROFILE EYE FLEX
 painted steel, flexible stem, plastic

- 9332
- ● 1xGU10, max 10W only LED

PROFILE WORKSHOP
 painted steel, copper-clad steel, plastic PC

- 9427
- ● 1xE27, max 60W

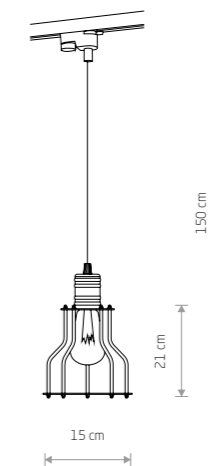

PROFILE WORKSHOP 9427



PROFILE IRIS LED 20W 9005



PROFILE EYE SPOT 9322

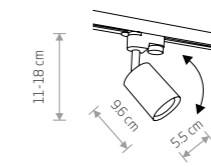

PROFILE EYE SPOT
 painted steel, plastic PC, chrome

- 9321 9322
- 1xGU10, max 10W only LED
- solid brass, plastic PC
- 7857
- 1xGU10, max 10W only LED



PROFILE VESPA 8825

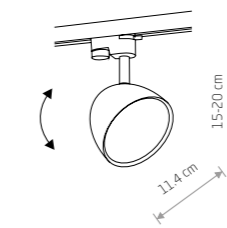

PROFILE VESPA
 painted steel, plastic PC, chrome

- 8824 8825
- 1xGU10 ES111, max 75W



PROFILE BIT PLUS 9018

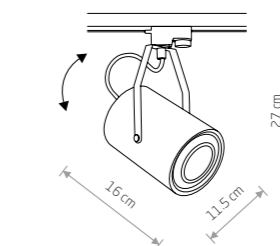

PROFILE BIT PLUS
 painted steel, plastic PC

- 9020 9018
- 1xGU10 ES111, max 75W

PROFILE TRACK LIGHTS SYSTEM



1 PROFILE TRACK 1 M
painted aluminum

9450 ■ 9448

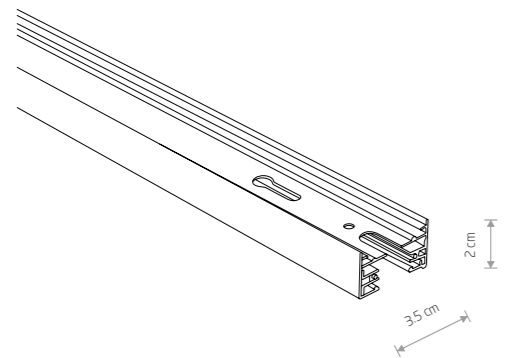

2 PROFILE TRACK 2 M
painted aluminum

9451 ■ 9452

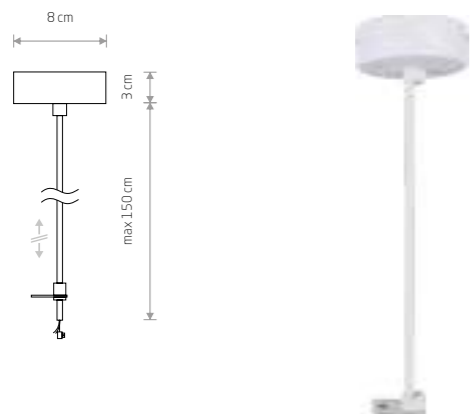

3 PROFILE POWER SUPPLY KIT
painted steel

9237 ■ 9238

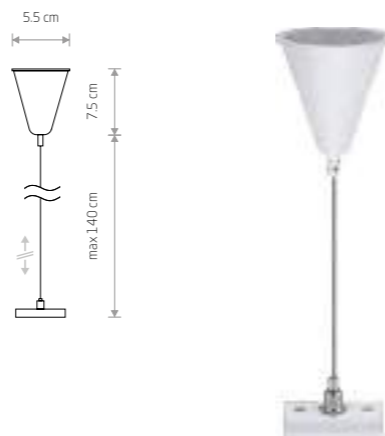

4 PROFILE SUSPENSION KIT
painted steel, plastic

9461 ■ 9460

System szynoprzewodowy należy równomiernie obciążyć elektrycznie oraz równomiernie rozmieścić oprawy na jego długości.
The track light system should be evenly electrically loaded and the fittings should be evenly placed along its length.
Система шинопроводов должна быть равномерно электрически нагружена, а светильники - равномерно распределены по её длине

Maksymalna długość jednego obwodu systemu szynoprzewodowego PROFILE - 20 m, a maksymalne obciążenie elektryczne - 1500W
The maximum length of one circuit of track light system PROFILE -20 m, and the maximum circuit power load - 1500W
Допустимая макс. длина системы шинопровода - 20 м, максимальная электрическая нагрузка - 1500W

WHITE ■ BLACK

Sposoby montażu / Installation methods / Методы монтажа

- 1. Zwieszenie na linkach stalowych
- 1. Suspended on steel wires
- 1. Подвеска на стальных тросах

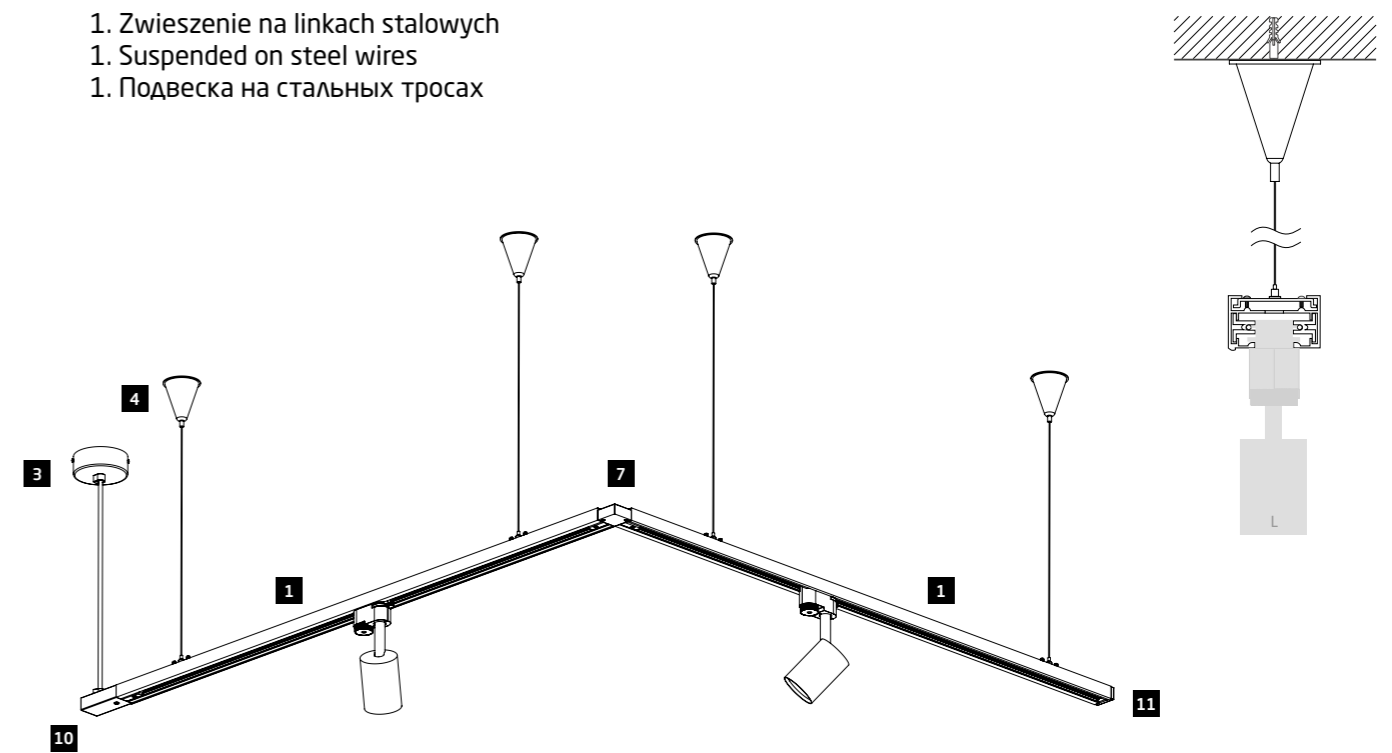

- 2. Montaż bezpośredni
- 2. Surface mounting
- 2. Прямой монтаж

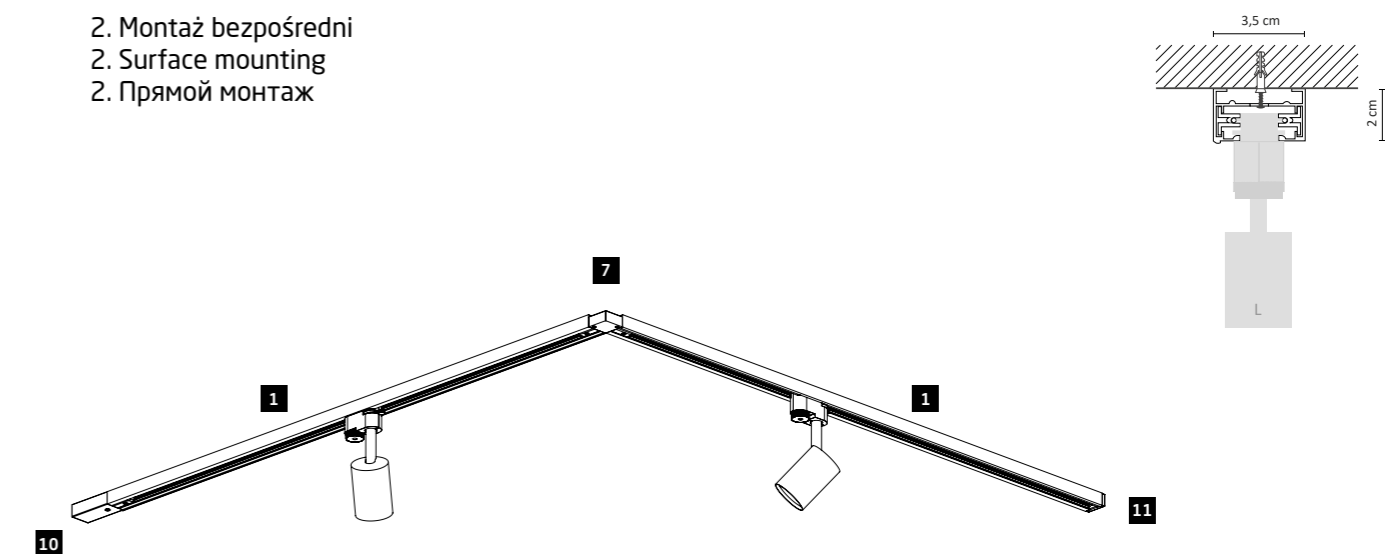

Zalecany dystans pomiędzy mocowaniami szyny max. 1000 mm
The recommended distance between tracks fasteners is 1000 mm
Рекомендуемое расстояние между креплениями не более 1000 мм

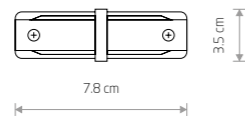
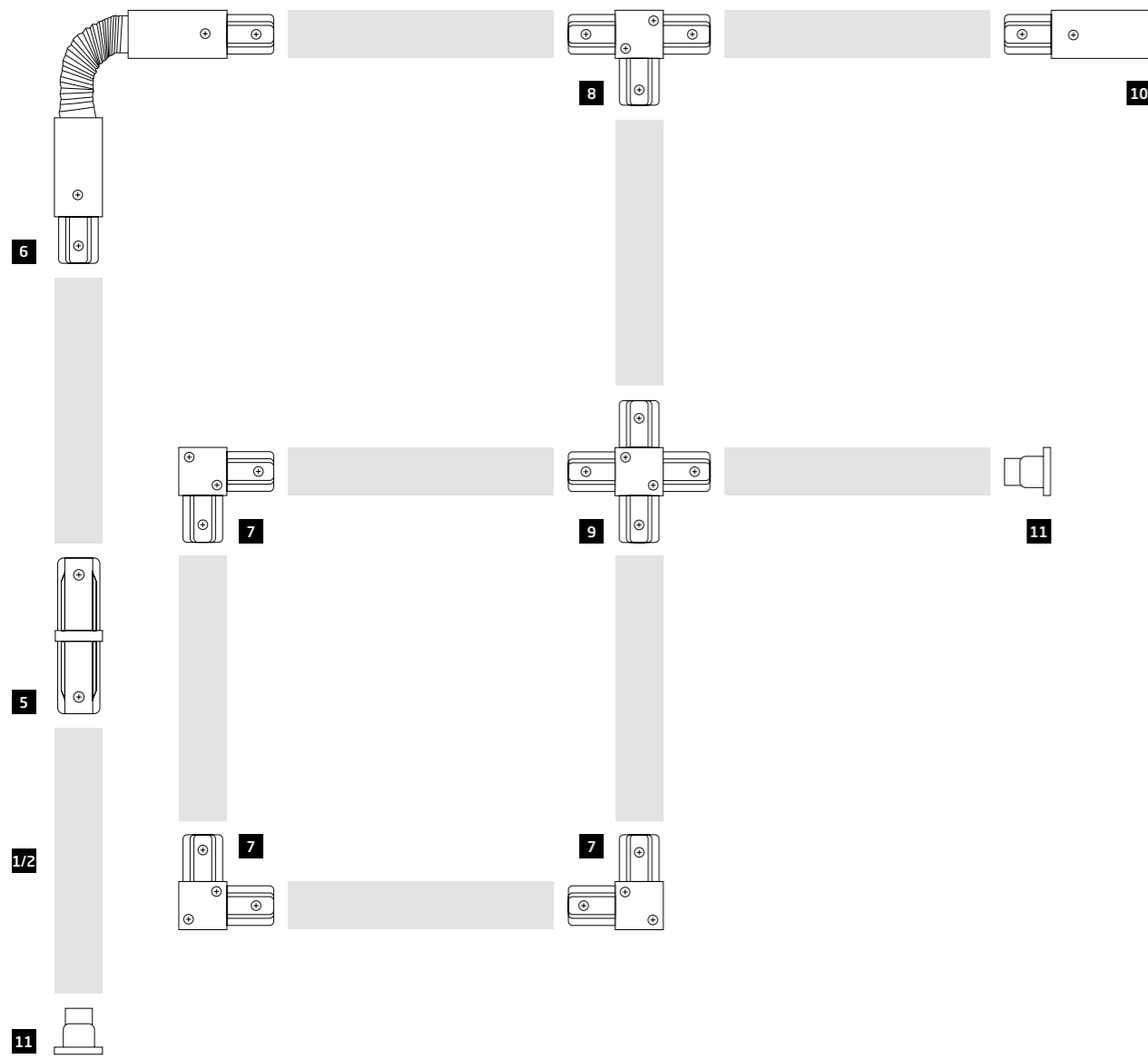

5 PROFILE STRAIGHT CONNECTOR

plastic PC, steel, copper

9454 9453

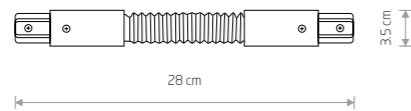

6 PROFILE FLEX CONNECTOR

plastic PC, steel, copper

8382 8383

7 PROFILE L CONNECTOR

plastic PC, steel, copper

9456 9455

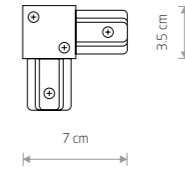

8 PROFILE T CONNECTOR

plastic PC, steel, copper

9187 9186

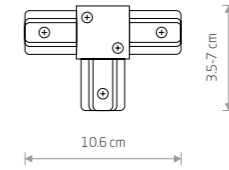

9 PROFILE X CONNECTOR

plastic PC, steel, copper

9190 9188

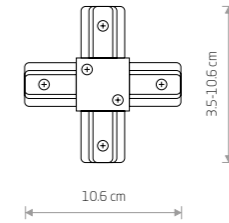

10 PROFILE POWER END CAP

plastic PC, steel, copper

9462 9463

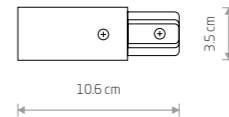

11 PROFILE DEAD END CAP

plastic PC

9457 9458

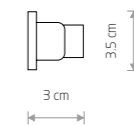



1 PROFILE RECESSED TRACK 1 METER

■ painted aluminum

■ 9012 ■ 9013

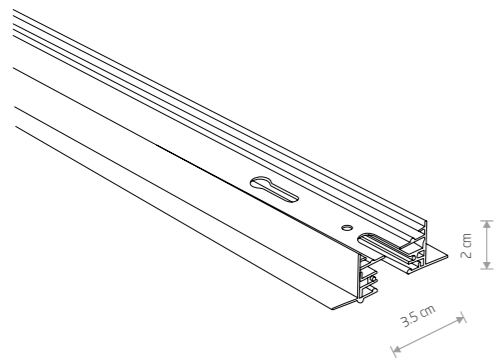

2 PROFILE RECESSED TRACK 2 METERS

■ painted aluminum

■ 9014 ■ 9015

- 1. Montaż podtynkowy
- 1. Recessed mounting
- 1. Скрытый монтаж

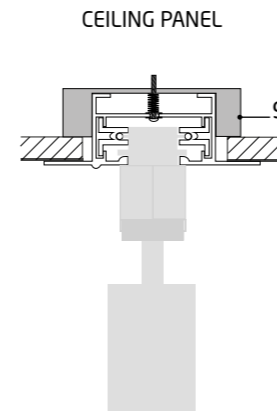
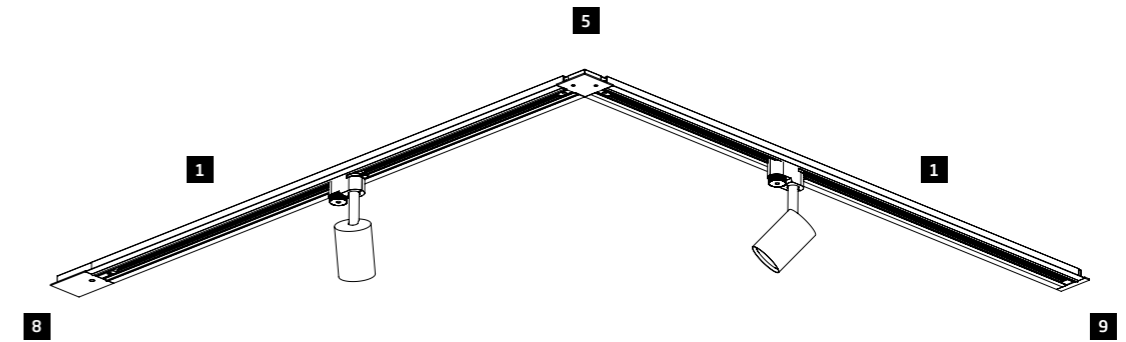

CEILING PANEL cut out 45 mm × X

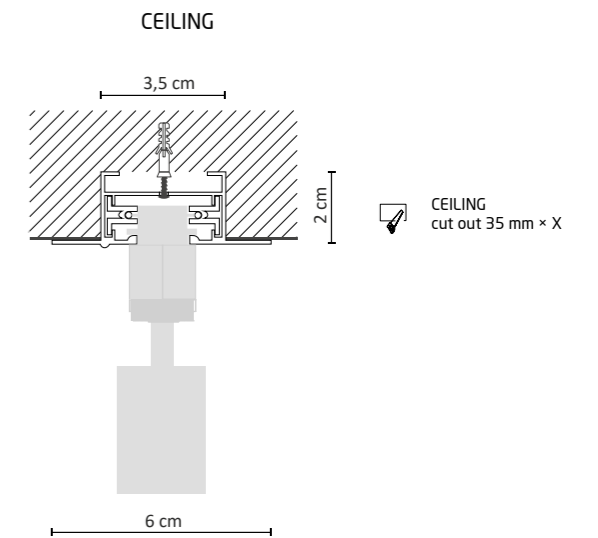

CEILING cut out 35 mm × X

System szynoprzewodowy należy równomiernie obciążyć elektrycznie oraz równomiernie rozmieścić oprawy na jego długości.
The track light system should be evenly electrically loaded and the fittings should be evenly placed along its length.
Система шинопроводов должна быть равномерно электрически нагружена, а светильники - равномерно распределены по её длине

Maksymalna długość jednego obwodu systemu szynoprzewodowego PROFILE - 20 m, a maksymalne obciążenie elektryczne - 1500W
The maximum length of one circuit of track light system PROFILE - 20 m, and the maximum circuit power load - 1500W
Допустимая макс. длина системы шинопровода - 20 м, максимальная электрическая нагрузка - 1500W

Zalecany dystans pomiędzy mocowaniami szyny max. 1000 mm
The recommended distance between tracks fasteners is 1000 mm
Рекомендуемое расстояние между креплениями не более 1000 мм

PROFILE RECESSED TRACK LIGHTS SYSTEM

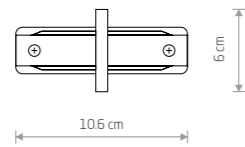
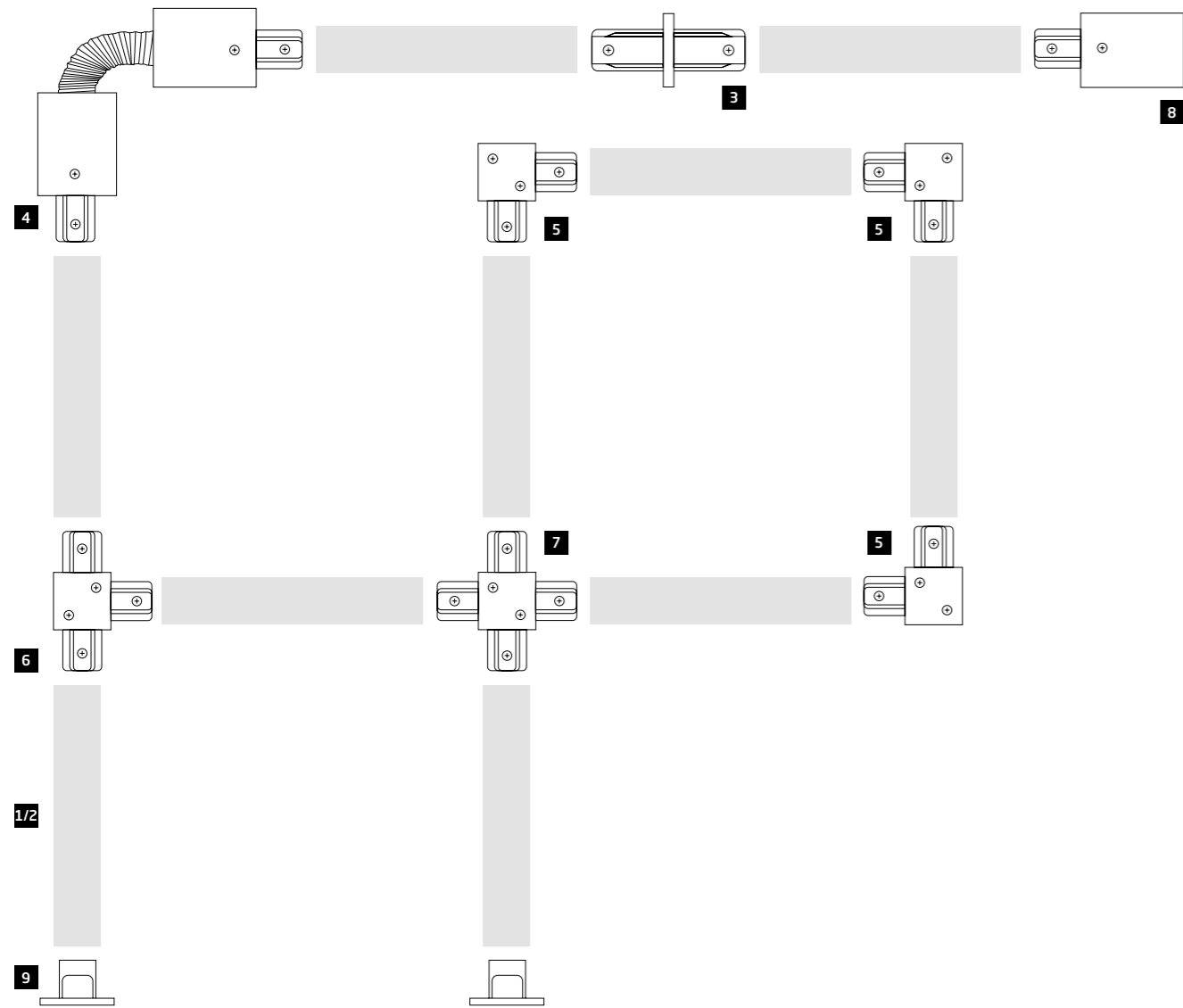

3 PROFILE RECESSED STRAIGHT CONNECTOR

plastic PC, steel, copper

8967 8968

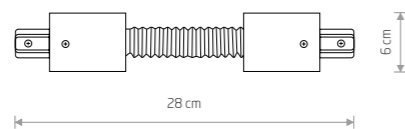

4 PROFILE RECESSED FLEX CONNECTOR

plastic PC, steel, copper

8384 8385

5 PROFILE RECESSED L CONNECTOR

plastic PC, steel, copper

8970 8971

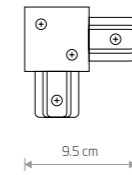

6 PROFILE RECESSED T CONNECTOR

plastic PC, steel, copper

8834 8835

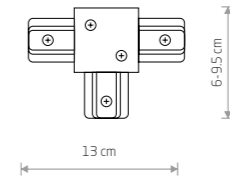

7 PROFILE RECESSED X CONNECTOR

plastic PC, steel, copper

8836 8837

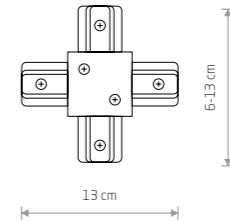

8 PROFILE RECESSED POWER END CAP

plastic PC, steel, copper

8972 8973

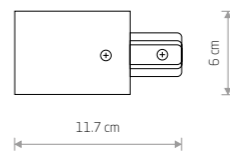

9 PROFILE RECESSED DEAD END CAP

plastic PC

8974 8975

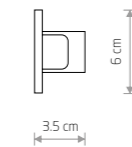

10 PROFILE RECESSED FIXING SET

steel

8805

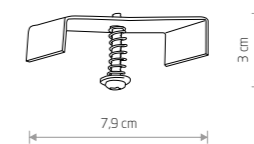

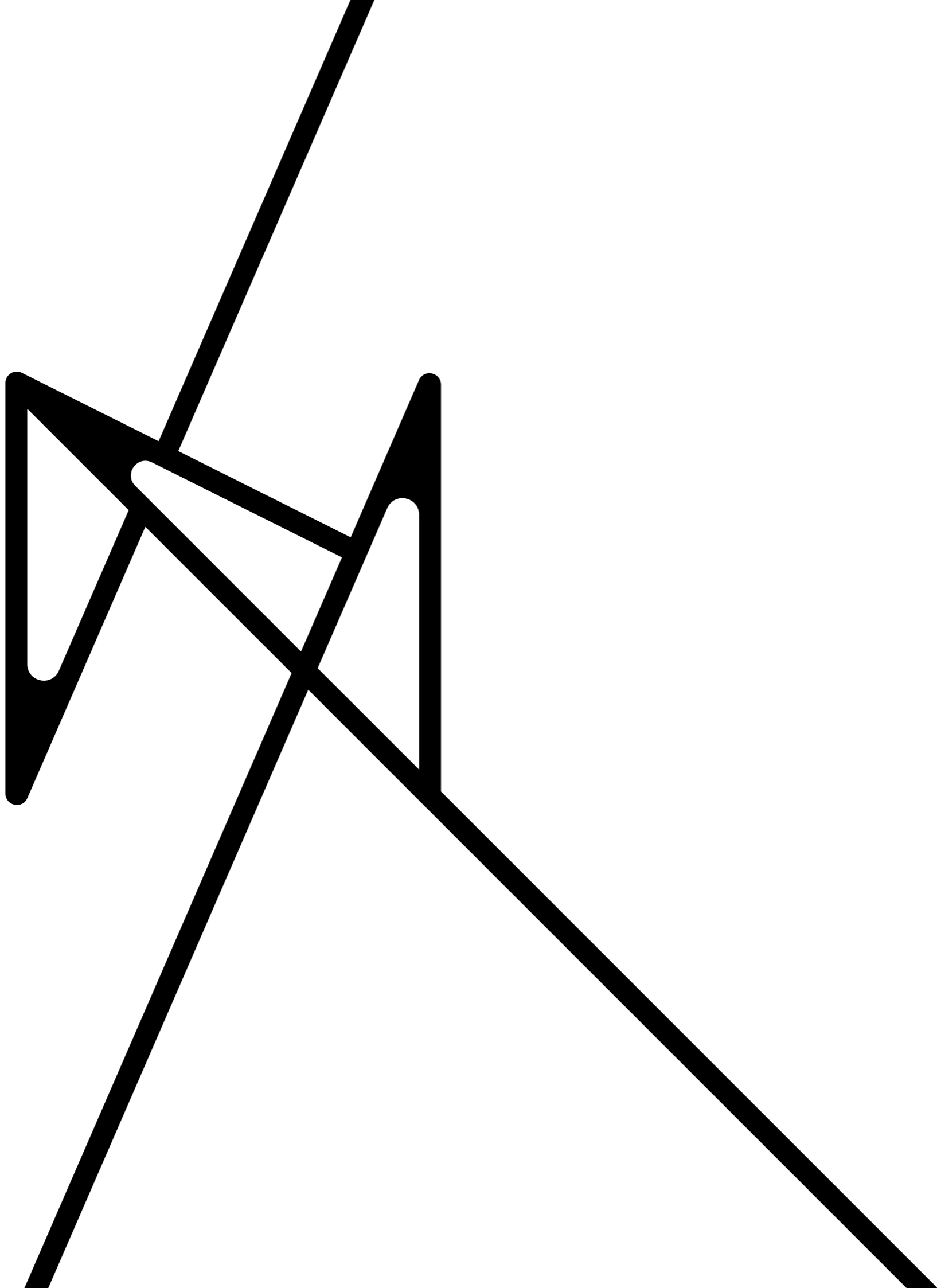

Bathroom
lighting

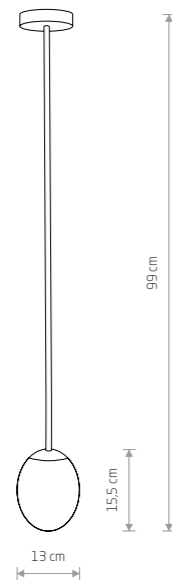

ICE EGG A

■ painted steel, glass

■ 8124

● 1xG9, max 25W
IP44

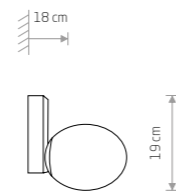

ICE EGG C

■ painted aluminum, glass

■ 8132

● 1xG9, max 25W
IP44

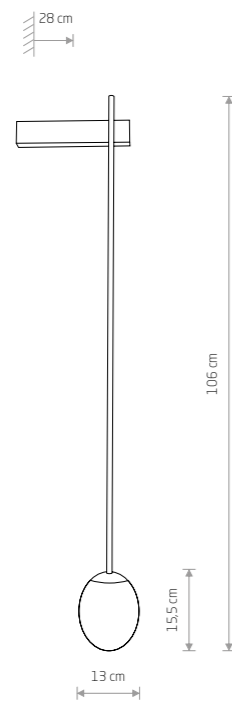

ICE EGG B

■ painted steel, glass

■ 8125

● 1xG9, max 25W
IP44





PIN LED S 8127

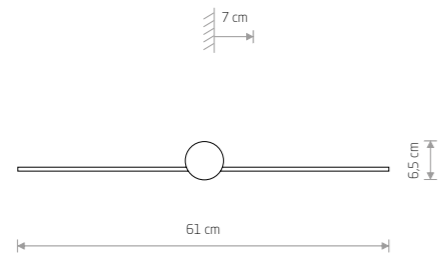

PIN LED S
painted aluminum, plastic PC

■ 8127

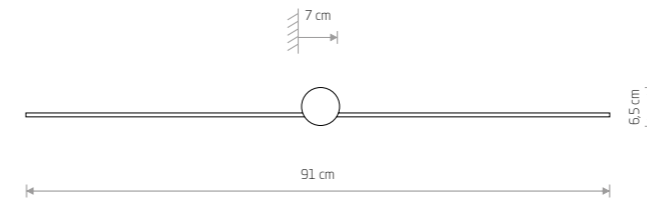

PIN LED M
painted aluminum, plastic PC

■ 8128

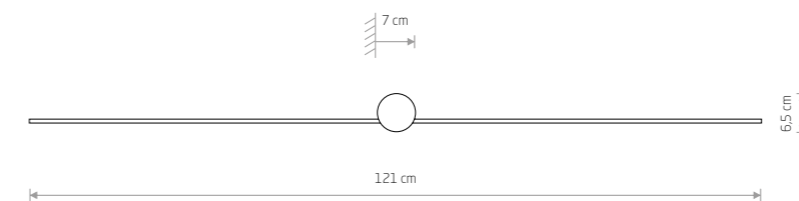

PIN LED L
painted aluminum, plastic PC

■ 8130



Item No.	Power	Colour temp.	Luminous flux	Beam angle	Colour Rendering Index (CRI)	Input	Safety type	Power factor	Ingress protection	Lifetime
8127	6W LED	4000K	280 lm	120°	≥80	~220-230 V, 50/60 Hz	☐	>0,9	IP44	30000h
8128	10W LED	4000K	500 lm	120°	≥80	~220-230 V, 50/60 Hz	☐	>0,9	IP44	30000h
8130	15W LED	4000K	700 lm	120°	≥80	~220-230 V, 50/60 Hz	☐	>0,9	IP44	30000h

VAN GOGH LED M 9350



VAN GOGH LED L 9174

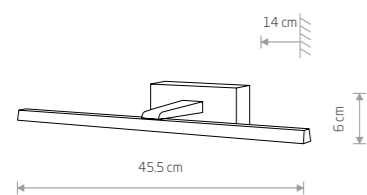

VAN GOGH LED S

Painted aluminum, plastic PC

9346 9348 9351

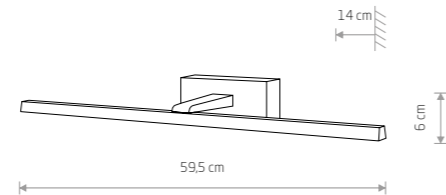

VAN GOGH LED M

Painted aluminum, plastic PC

9347 9350 9352

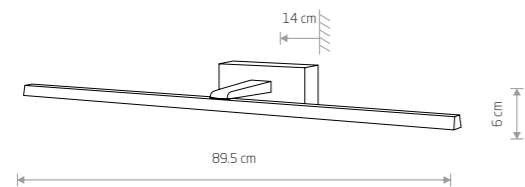

VAN GOGH LED L

Painted aluminum, plastic PC

9176 9175 9174



Item No.	Power	Colour temp.	Luminous flux	Beam angle	Colour Rendering Index (CRI)	Input	Safety type	Power factor	Ingress protection	Lifetime
9346	9W LED	3000K	370 lm	120°	≥ 80	~220-230 V, 50/60 Hz	⊕	>0,5	IP44	30000h
9348	9W LED	3000K	430 lm	120°	≥ 80	~220-230 V, 50/60 Hz	⊕	>0,5	IP44	30000h
9351	9W LED	3000K	290 lm	120°	≥ 80	~220-230 V, 50/60 Hz	⊕	>0,5	IP44	30000h
9347	13W LED	3000K	490 lm	120°	≥ 80	~220-230 V, 50/60 Hz	⊕	>0,5	IP44	30000h
9350	13W LED	3000K	640 lm	120°	≥ 80	~220-230 V, 50/60 Hz	⊕	>0,5	IP44	30000h
9352	13W LED	3000K	430 lm	120°	≥ 80	~220-230 V, 50/60 Hz	⊕	>0,5	IP44	30000h
9176	18W LED	3000K	800 lm	120°	≥ 80	~220-230 V, 50/60 Hz	⊕	>0,5	IP44	30000h
9175	18W LED	3000K	940 lm	120°	≥ 80	~220-230 V, 50/60 Hz	⊕	>0,5	IP44	30000h
9174	18W LED	3000K	650 lm	120°	≥ 80	~220-230 V, 50/60 Hz	⊕	>0,5	IP44	30000h

BLACK

WHITE

CHROME

VAN GOGH LED M 9347





PICASSO LED

chrome plated aluminum, plastic PC

8131

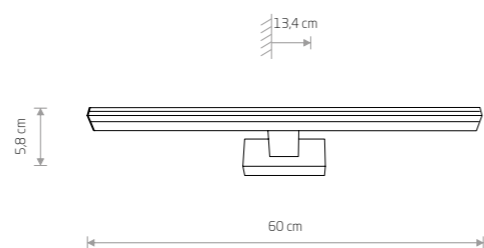

LATH LED

chrome plated steel, plastic PC

8175

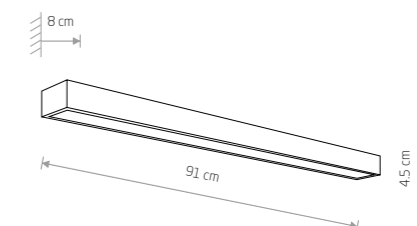
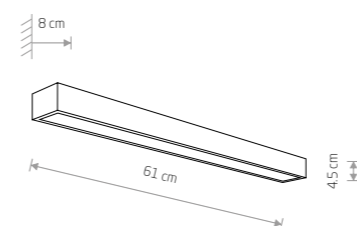
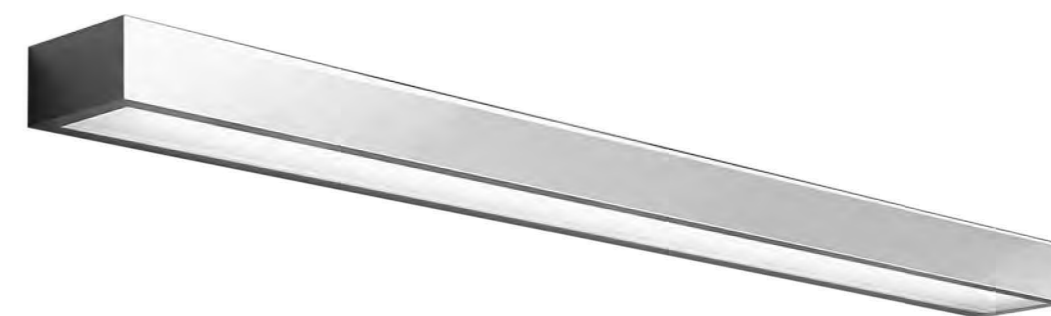
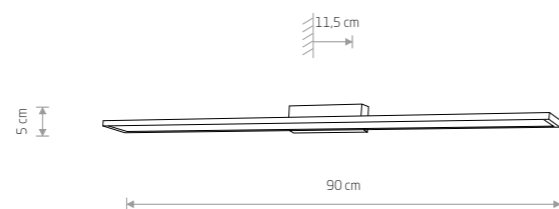

KAGERA LED M

chrome plated aluminum, glass

9503



KAGERA LED L

chrome plated aluminum, glass

9502



Item No.	Power	Colour temp.	Luminous flux	Beam angle	Colour Rendering Index (CRI)	Input	Safety type	Power factor	Ingress protection	Lifetime
8131	12W LED	4000K	900 lm	120°	≥80	~220-230 V, 50/60 Hz	⊕	>0,5	IP44	30000h
8175	16W LED	4000K	1000 lm	120°	≥80	~220-230 V, 50/60 Hz	⊕	>0,5	IP44	20000h

Item No.	Power	Colour temp.	Luminous flux	Beam angle	Colour Rendering Index (CRD)	Input	Safety type	Power factor	Ingress protection	Lifetime
9502	24W LED	4000K	1380 lm	120°	≥ 80	~220-230 V, 50/60 Hz	⊕	>0,5	IP44	20000h
9503	18W LED	4000K	1000 lm	120°	≥ 80	~220-230 V, 50/60 Hz	⊕	>0,5	IP44	20000h

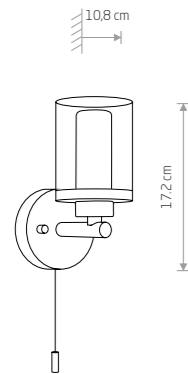

VISTA
chrome plated steel, glass

- 8051
- 1xG9, max 25W only LED
- IP44

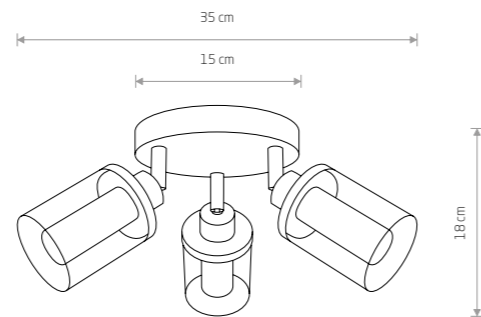

VISTA
chrome plated steel, glass

- 8050
- 3xG9, max 25W only LED
- IP44

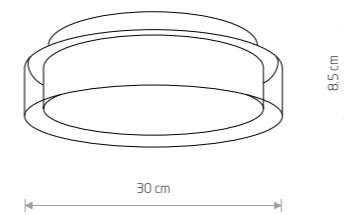

PAN LED S
glass, chrome plated steel

- 8173

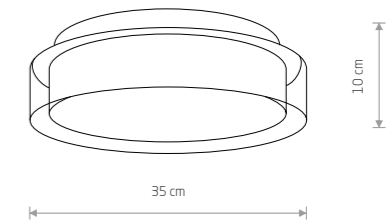

PAN LED M
glass, chrome plated steel

- 8174

Item No.	Power	Colour temp.	Luminous flux	Beam angle	Colour Rendering Index (CRI)	Input	Safety type	Power factor	Ingress protection	Lifetime
8173	12W LED	4000K	530 lm	120°	≥80	~220-230 V, 50/60 Hz	⊕	>0,5	IP44	20000h
8174	17W LED	4000K	800 lm	120°	≥80	~220-230 V, 50/60 Hz	⊕	>0,5	IP44	20000h



CAYO 8055

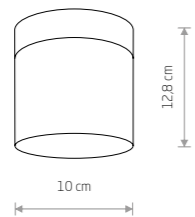

CAYO

glass, painted steel

■ 8055

● 1xG9, max 40W

IP44

glass, chrome plated steel

▨ 9505

● 1xG9, max 40W

IP44

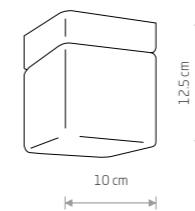

SIS

glass, painted steel

■ 8054

● 1xG9, max 40W

IP44

glass, chrome plated steel

▨ 9506

● 1xG9, max 40W

IP44

■ BLACK

■ WHITE

▨ CHROME

■ WHITE

■ BLACK

▨ CHROME



BALI 9353

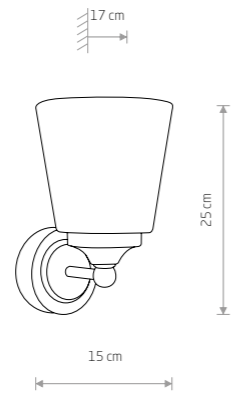
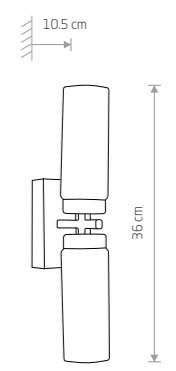
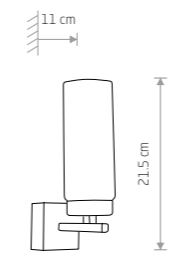

BALI

- glass, painted steel
- 8053
- 1xE14, max 25W
- glass, chrome plated steel
- 9353
- 1xE14, max 25W
- IP44

CELTIC

- glass, chrome plated steel
- 3346
- 1xE14, max 40W
- IP44

CELTIC

- glass, chrome plated steel
- 3347
- 2xE14, max 40W
- IP44



BRAZOS 6951

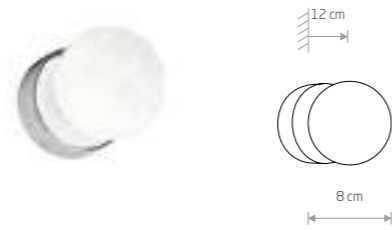

BRAZOS

glass, chrome plated steel

6948

1xG9, max 25W
IP44



BRAZOS

glass, chrome plated steel

6950

2xG9, max 25W
IP44

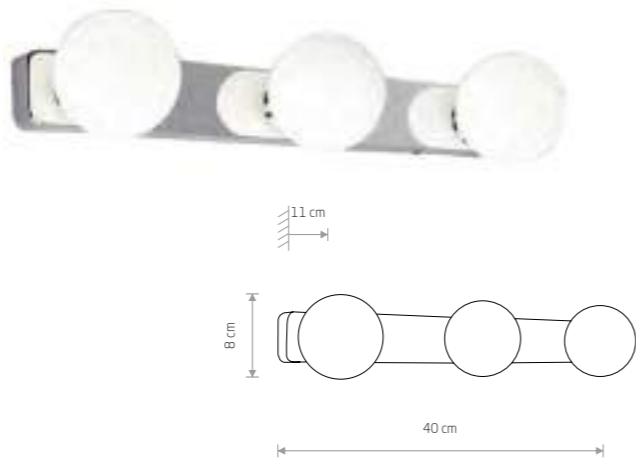

BRAZOS

glass, chrome plated steel

6951

3xG9, max 25W
IP44



SIMI

painting steel, glass

8052

1xG9, max 25W
IP44



BRAZOS

glass, painted steel

8057

1xG9, max 25W
IP44

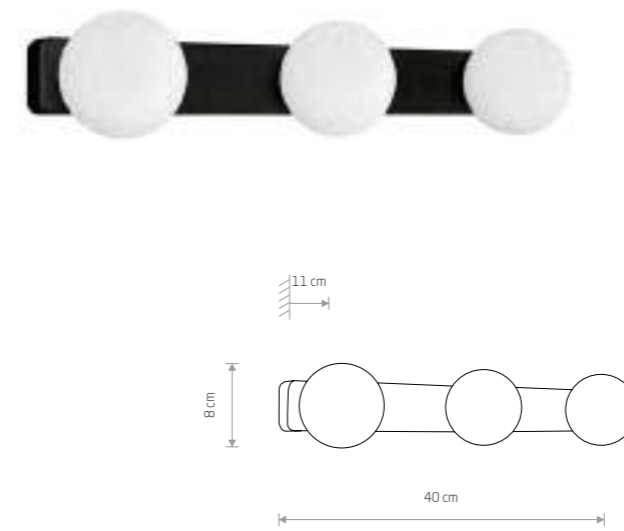

BRAZOS

glass, painted steel

8056

3xG9, max 25W
IP44

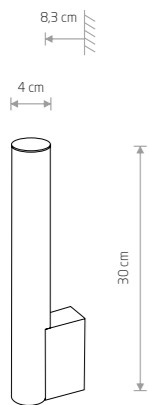

ICE TUBE LED S
plastic PC, chrome plated steel

8121

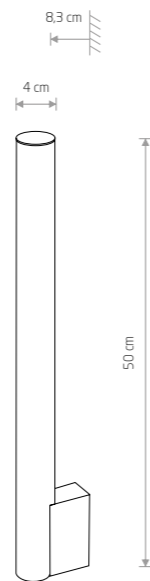

ICE TUBE LED M
plastic PC, chrome plated steel

8122

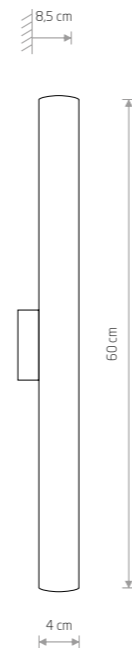

ICE TUBE LED S
plastic PC, chrome plated steel

8118

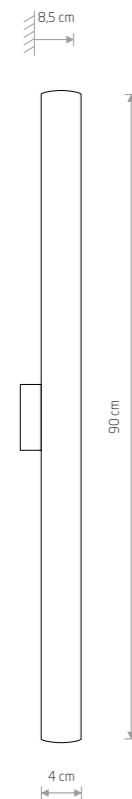

ICE TUBE LED M
plastic PC, chrome plated steel

8120



Item No.	Power	Colour temp.	Luminous flux	Beam angle	Colour Rendering Index (CRI)	Input	Safety type	Power factor	Ingress protection	Lifetime
8121	5W LED	4000K	380 lm	120°	≥80	~220-230 V, 50/60 Hz	☑	>0,5	IP44	30000h
8122	8W LED	4000K	630 lm	120°	≥80	~220-230 V, 50/60 Hz	☑	>0,5	IP44	30000h

Item No.	Power	Colour temp.	Luminous flux	Beam angle	Colour Rendering Index (CRI)	Input	Safety type	Power factor	Ingress protection	Lifetime
8118	12W LED	4000K	1200 lm	120°	≥80	~220-230 V, 50/60 Hz	☑	>0,4	IP44	30000h
8120	18W LED	4000K	1750 lm	120°	≥80	~220-230 V, 50/60 Hz	☑	>0,4	IP44	30000h

ICE BALL 8126

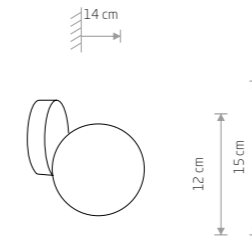

ICE BALL
brass-plated steel, glass

8126

1xG9, max 25W
IP44

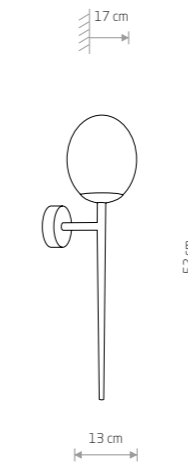

TORCH
chrome plated steel, glass

8123

1xG9, max 25W
IP44



MALAKKA LED 9501



BASSA LED 9500

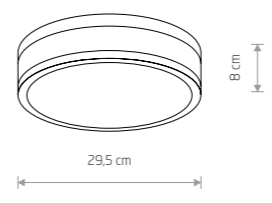
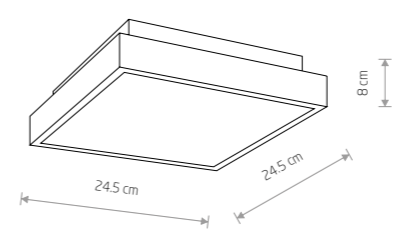

BASSA LED
chrome plated steel, glass

- 9500

MALAKKA LED
chrome plated steel, glass

- 9501

Item No.	Power	Colour temp.	Luminous flux	Beam angle	Colour Rendering Index (CRI)	Input	Safety type	Power factor	Ingress protection	Lifetime
9500	18W LED	4000K	750 lm	120°	≥ 80	~220-230 V, 50/60 Hz	⊕	>0,5	IP44	20000h
9501	18W LED	4000K	940 lm	120°	≥ 80	~220-230 V, 50/60 Hz	⊕	>0,5	IP44	20000h

WHITE CHROME



ARENA LED 8274



ARENA 6724

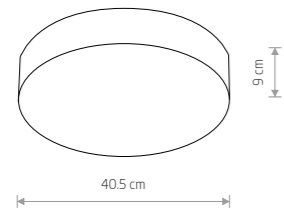

ARENA

painting steel, plastic PMMA

- 6724 6725
- 6770 8273
- 3xE14, max 20W
- IP44

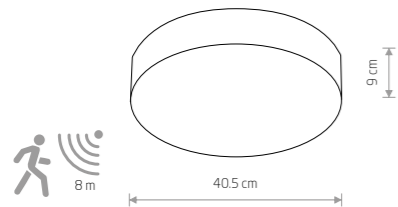

ARENA SENSOR

painting steel, plastic PMMA

- 8832 8833 7953
- 3xE14, max 20W
- IP44

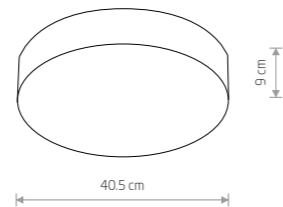

ARENA LED

painting steel, plastic PMMA

- 6726 6727
- 6771 8274



ARENA LED 6727

Item No.	Power	Colour temp.	Luminous flux	Beam angle	Colour Rendering Index (CRI)	Input	Safety type	Power factor	Ingress protection	Lifetime
6726	18W LED	4000K	1600 lm	100°	≥ 80	~220-230 V, 50/60 Hz	⊕	>0,95	IP44	50000h
6727	18W LED	4000K	1600 lm	100°	≥ 80	~220-230 V, 50/60 Hz	⊕	>0,95	IP44	50000h
6771	18W LED	4000K	1600 lm	100°	≥ 80	~220-230 V, 50/60 Hz	⊕	>0,95	IP44	50000h
8274	18W LED	4000K	1600 lm	100°	≥ 80	220-230 V, 50/60 Hz	⊕	>0,95	IP44	50000h

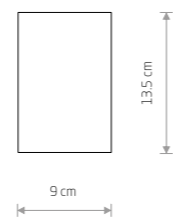

BRAVO

painting aluminum, glass

8364 8365

1xGU10, max 15W

IP54

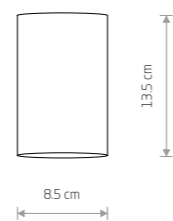

ALPHA

painting aluminum, glass

8362 8363

1xGU10, max 15W

IP54

ALPHA 8363





FOXTROT 8373

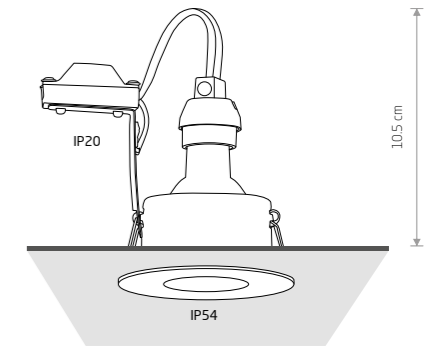
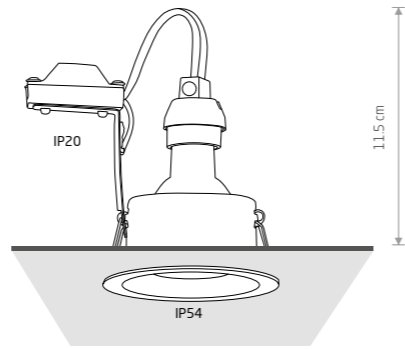
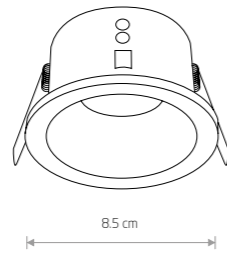

CHARLIE

painting aluminum, glass

- 8366 8367
- 1xGU10, max 15W
- IP54/20
- cut out ø 75 mm

GOLF

painting aluminum, glass

- 8375 8376
- 1xGU10, max 15W
- IP54/20
- cut out ø 68 mm

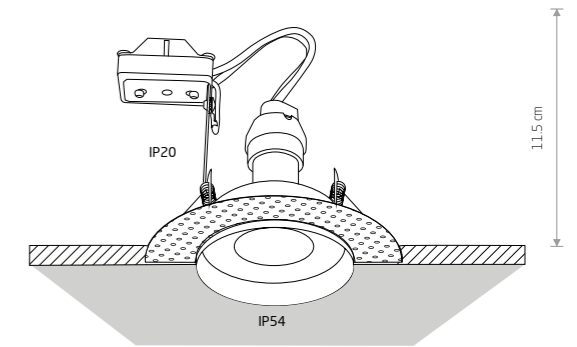
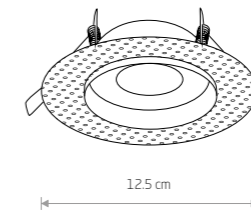
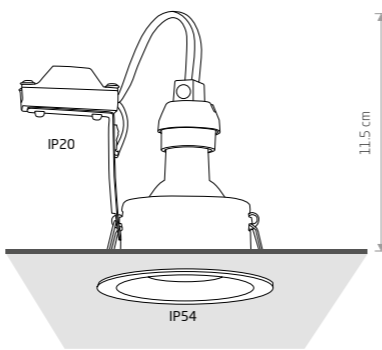
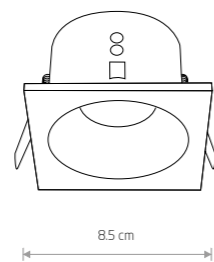

DELTA

painting aluminum, glass

- 8368 8370
- 1xGU10, max 15W
- IP54/20
- cut out ø 75 mm

ECHO

painting aluminum, glass

- 8371 8372
- 1xGU10, max 15W
- IP54/20
- cut out ø 80 mm



ZESTAW ZAWIERA 4 KOLOROWE NAKŁADKI.
THE SET INCLUDES FOUR COLOURED RINGS.
В КОМПЛЕКТЕ 4 ЦВЕТНЫЕ НАКЛАДКИ

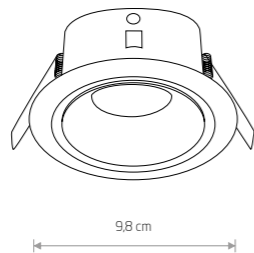
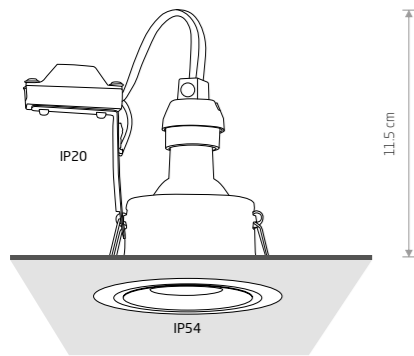

FOXTROT
painted aluminum, glass

- 8373 8374
- 1xGU10, max 15W
- IP54/20
- cut out ø 85 mm

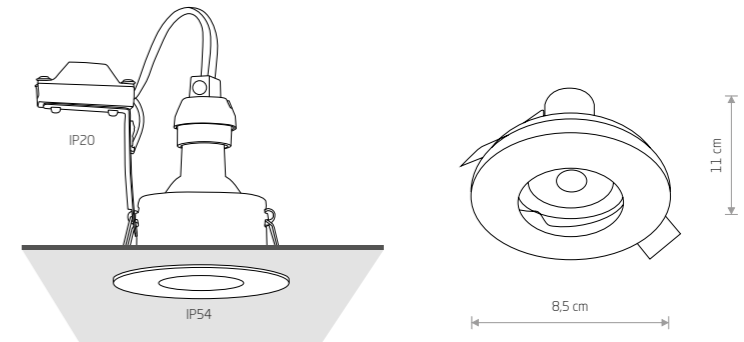

JULIET
steel

- 7663 7664
- 1xGU10, max 15W
- IP54/20
- cut out 56 mm

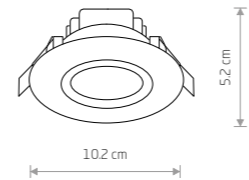

HELIOS LED
plastic PC

- 8991 3000K 8992 4000K
- cut out ø 85 mm

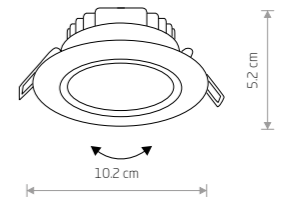

EOL LED
plastic PC

- 8988 3000K 8990 4000K
- cut out ø 85 mm

Item No.	Power	Colour temp.	Luminous flux	Beam angle	Colour Rendering Index (CRI)	Input	Safety type	Power factor	Ingress protection	Lifetime
8991	5W LED	3000K	300 lm	100°	≥ 80	~220-230 V, 50/60 Hz	☐	>0,5	IP44	20000h
8992	5W LED	4000K	300 lm	100°	≥ 80	~220-230 V, 50/60 Hz	☐	>0,5	IP44	20000h
8988	5W LED	3000K	350 lm	90°	≥ 80	~220-230 V, 50/60 Hz	☐	>0,5	IP44	20000h
8990	5W LED	4000K	400 lm	90°	≥ 80	~220-230 V, 50/60 Hz	☐	>0,5	IP44	20000h

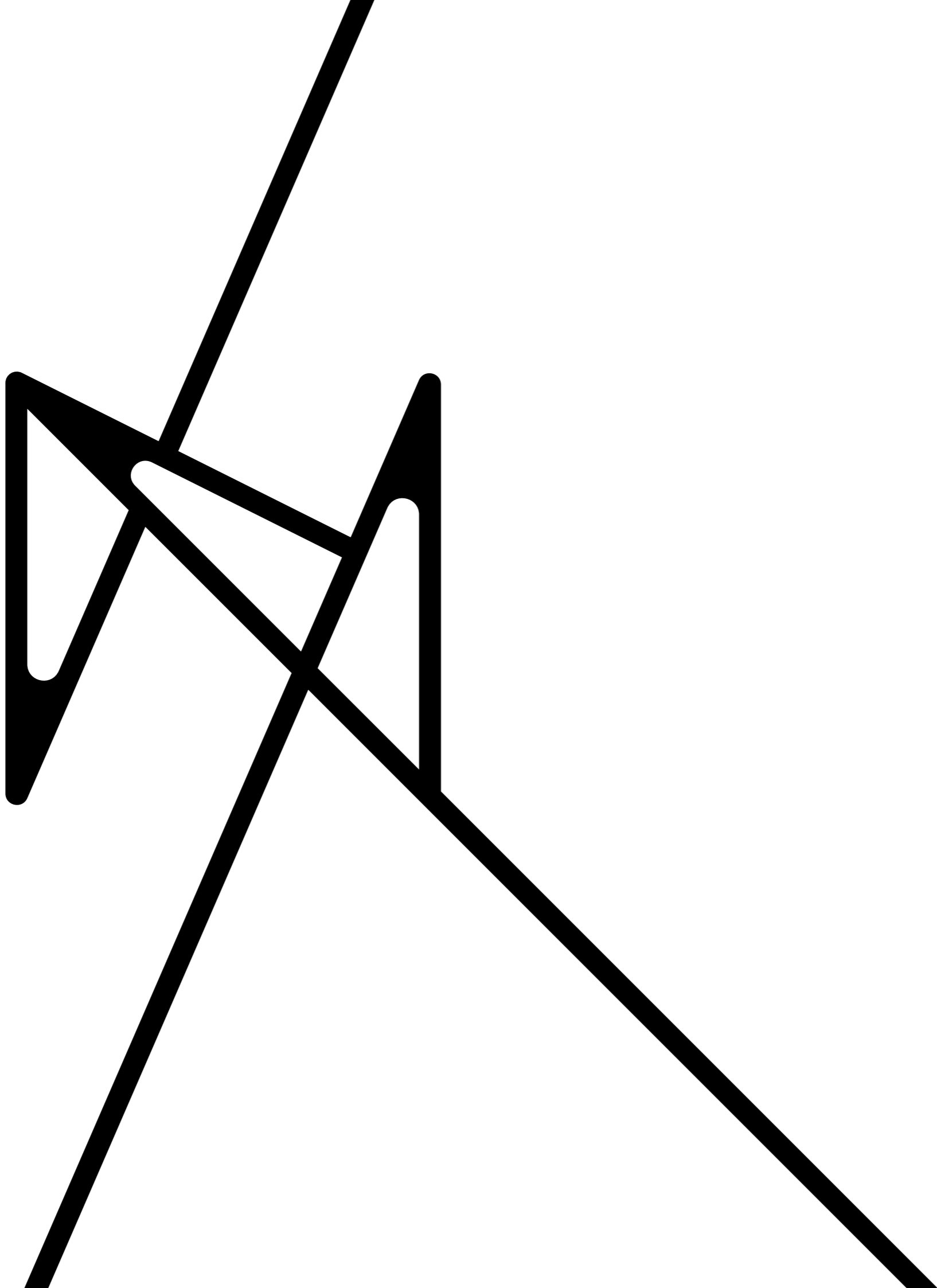

Outdoor
lighting



CUMULUS M 9715



CUMULUS L 6978



CUMULUS S 6976

CUMULUS M 6977





CUMULUS L 6978



CUMULUS S 9751



CUMULUS M 9715

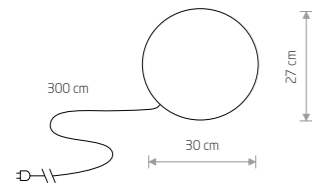

CUMULUS S

plastic PE

6976

1xE27, max 40W

IP44

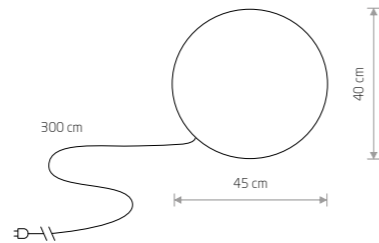

CUMULUS M

plastic PE

6977

1xE27, max 60W

IP44

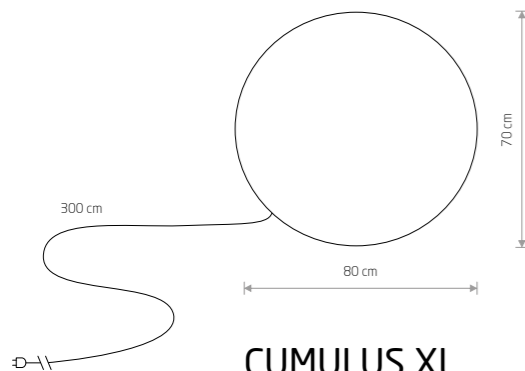

CUMULUS XL

plastic PE

9714

1xE27, max 60W

IP44

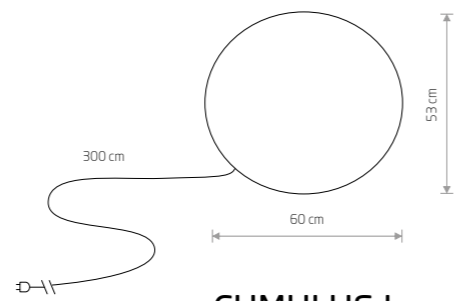

CUMULUS L

plastic PE

6978

1xE27, max 60W

IP44

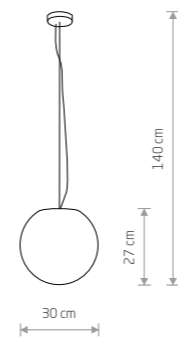

CUMULUS S

plastic PE, painted steel

9751

1xE27, max 60W

IP65

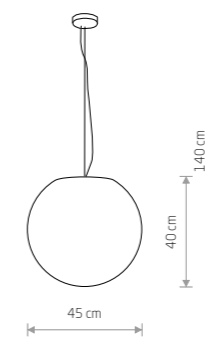

CUMULUS M

plastic PE, painted steel

9715

1xE27, max 60W

IP65

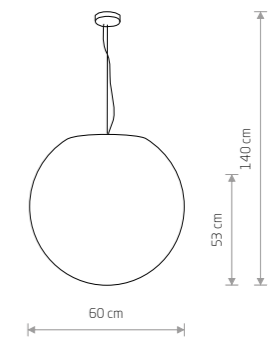

CUMULUS L

plastic PE

9607

1xE27, max 60W

IP65

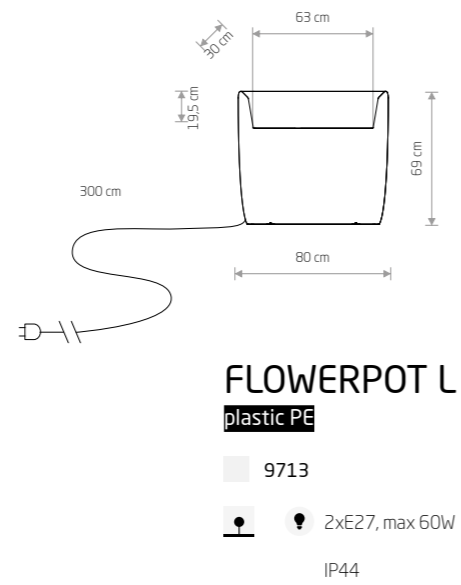
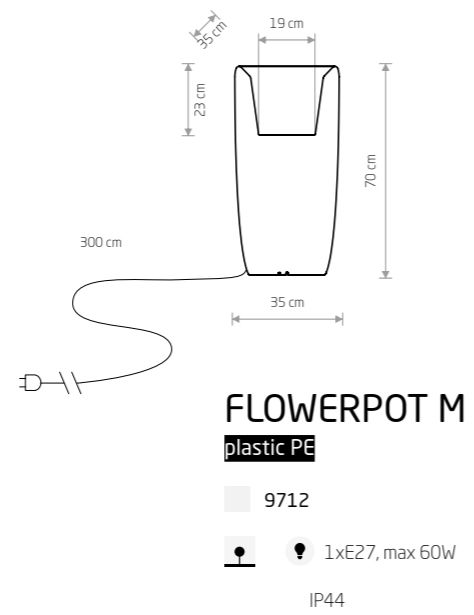
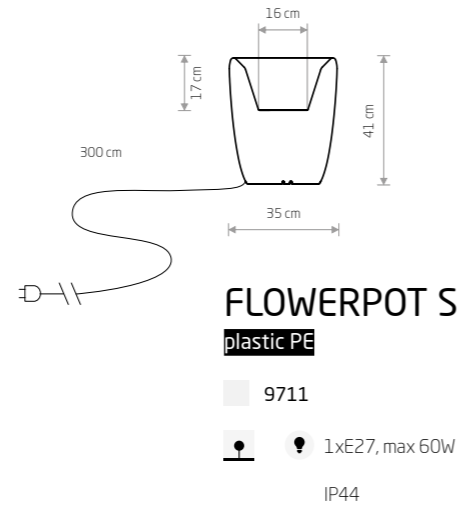

FLOWERPOT S 9711

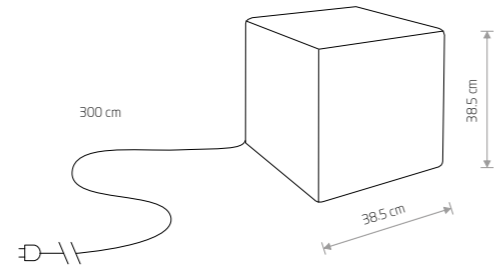

CUMULUS CUBE M

plastic PE

8966

1xE27, max 60W

IP44

STAR

plastic PE

9426

1xE27, max 40W

IP44

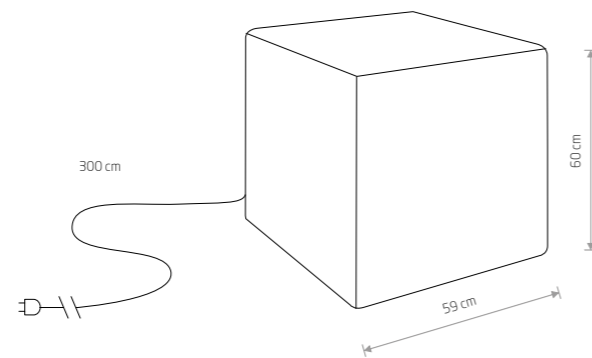
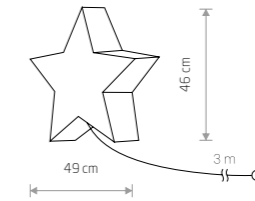

CUMULUS CUBE L

plastic PE

8965

1xE27, max 60W

IP44

GALAXY

plastic PE, painted steel

9246

1xE27, max 40W

IP65

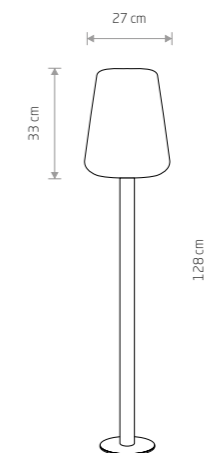

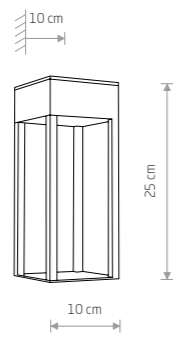

STRUCTURE LED

Painted aluminum, plastic PC

■ 8146

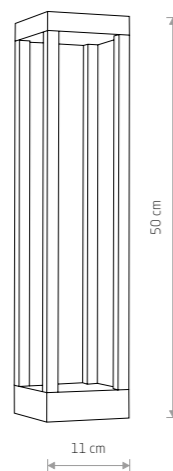

STRUCTURE LED

Painted aluminum, plastic PC

■ 8145



Item No.	Power	Colour temp.	Luminous flux	Beam angle	Colour Rendering Index (CRI)	Input	Safety type	Power factor	Ingress protection	Lifetime
8145	13W LED	3000K	820 lm	120°	≥80	~220-230 V, 50/60 Hz	⊕	>0,9	IP54	20000h
8146	13W LED	3000K	820 lm	120°	≥80	~220-230 V, 50/60 Hz	⊕	>0,9	IP54	20000h

■ BLACK



STRUCTURE LED 8145



SYMMETRY LED 8176

SYMMETRY LED

painting aluminum, plastic PC

■ 8176

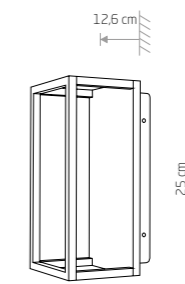

SYMMETRY LED

painting aluminum, plastic PC

■ 8180

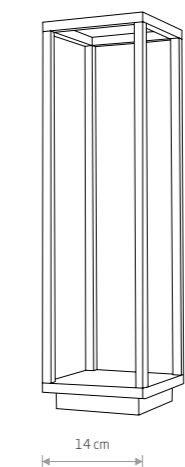

Item No.	Power	Colour temp.	Luminous flux	Beam angle	Colour Rendering Index (CRI)	Input	Safety type	Power factor	Ingress protection	Lifetime
8176	7W LED	3000K	212 lm	67 °	85	~220-230 V, 50/60 Hz	⊕	>0,5	IP54	30000h
8180	7W LED	3000K	388 lm	66 °	85	~220-230 V, 50/60 Hz	⊕	>0,85	IP54	30000h

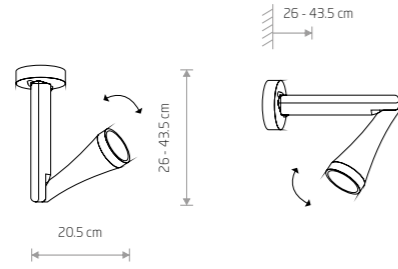

OTTAWA

■ painted aluminum, glass

■ 9562

● 1xGU10, max 35W

IP44

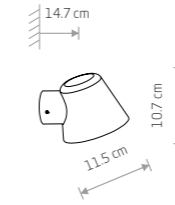

SOUL

■ painted aluminum, glass

■ 9555

● 1xGU10, max 35W

IP44

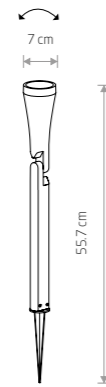

OTTAWA

■ painted aluminum, glass

■ 9561

● 1xGU10, max 35W

IP44



OTTAWA

■ painted aluminum, glass

■ 9563

● 1xGU10, max 35W

IP44

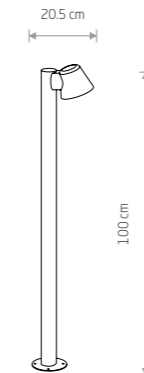

SOUL

■ painted aluminum, glass

■ 9557

● 1xGU10, max 35W

IP44



SOUL 9557



TUBINGS M 8161



TUBINGS 8158

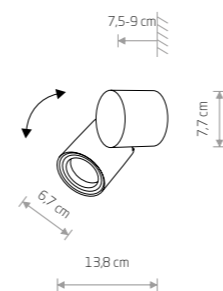

TUBINGS S

■ painted aluminum, glass

■ 8160

🔌 1xGU10, max 35W

IP54

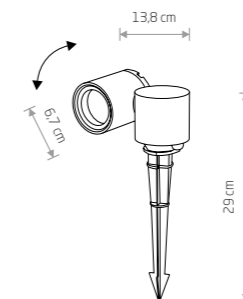

TUBINGS M

■ painted aluminum, glass, plastic

■ 8161

🔌 1xGU10, max 35W

IP54

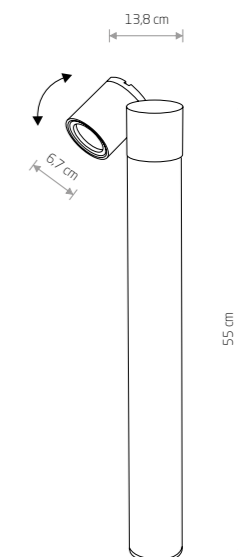

TUBINGS

■ painted aluminum, glass

■ 8158

🔌 1xGU10, max 35W

IP54

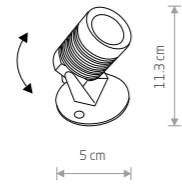

SPIKE LED S
 painted aluminum, glass

■ 9101

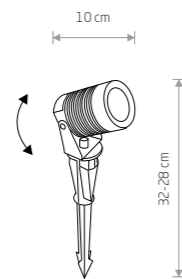

SPIKE LED M
 painted aluminum, glass, plastic

■ 9100



BUSH 3401

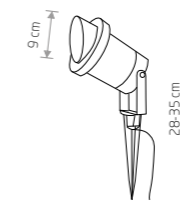

BUSH
 painted aluminum, glass

■ 3401

● 1xGU10, max 35W

IP65

Item No.	Power	Colour temp.	Luminous flux	Beam angle	Colour Rendering Index (CRI)	Input	Safety type	Power factor	Ingress protection	Lifetime
9100	5W LED	3000K	330 lm	30°	>80	~220-230 V, 50/60 Hz	⊕	>0,55	IP54	10000h
9101	5W LED	3000K	330 lm	30°	>80	~220-230 V, 50/60 Hz	⊕	>0,55	IP54	10000h



THIKA LED 9118

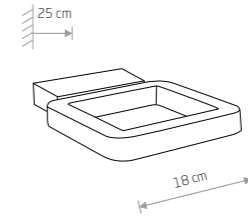

THIKA LED B
painted aluminum, glass

■ 9120

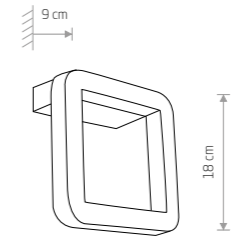

THIKA LED A
painted aluminum, glass

■ 9121

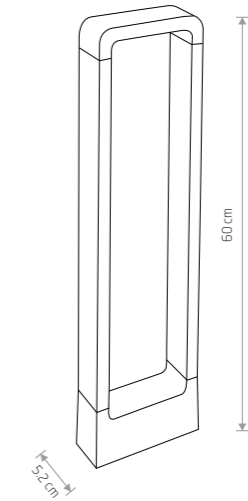

THIKA LED
painted aluminum, glass

■ 9118



Item No.	Power	Colour temp.	Luminous flux	Beam angle	Colour Rendering Index (CRI)	Input	Safety type	Power factor	Ingress protection	Lifetime
9118	9W LED	3000K	550 lm	39°	≥ 80	~220-230 V, 50/60 Hz	⊕	>0,5	IP54	20000h
9120	15W LED	3000K	1035 lm	110°	≥ 80	~220-230 V, 50/60 Hz	⊕	>0,9	IP54	20000h
9121	10W LED	3000K	996 lm	110°	≥ 80	~220-230 V, 50/60 Hz	⊕	>0,9	IP54	20000h

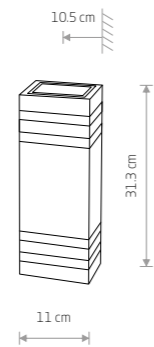

RIO

4424
painted aluminum, plastic PC

4424

2xE27, max 40W

IP54

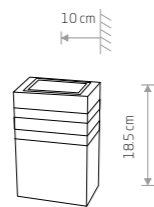

RIO

4423
painted aluminum, plastic PC

4423

1xE27, max 40W

IP54

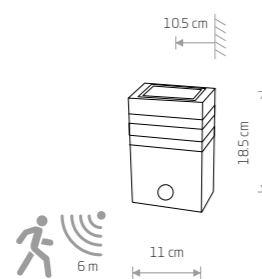

RIO SENSOR

7017
painted aluminum, plastic PC

7017

1xE27, max 40W

IP54



RIO SENSOR

9097
painted aluminum, plastic PC

9097

1xE27, max 40W

IP54



RIO SENSOR 9097

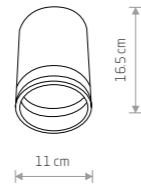

ROCK

■ painted aluminum, plastic PC

■ 3406

● 1xE27, max 60W

IP44

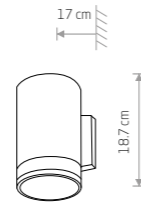

ROCK

■ painted aluminum, plastic PC

■ 3405

● 1xE27, max 60W

IP44

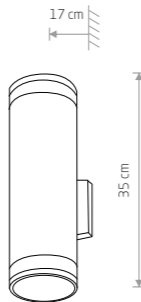

ROCK

■ painted aluminum, plastic PC

■ 3407

● 2xE27, max 60W

IP44

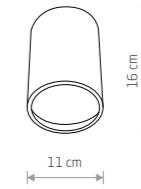

FOG

■ painted aluminum, glass

■ 3403

● 1xE27, max 60W

IP44

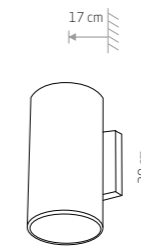

FOG

■ painted aluminum, glass

■ 3402

● 1xE27, max 60W

IP44

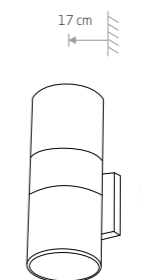

FOG

■ painted aluminum, glass

■ 3404

● 2xE27, max 60W

IP44

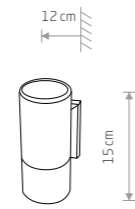

NEGRO
 painted aluminum, glass
 ■ 4425
 ● 1xGU10, max 35W
 IP54

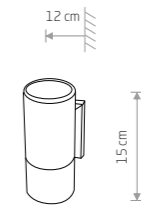

EXE
 painted aluminum, glass
 ■ 8331
 ● 1xGU10, max 35W
 IP54

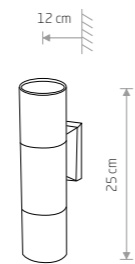

NEGRO
 painted aluminum, glass
 ■ 4426
 ● 2xGU10, max 35W
 IP54

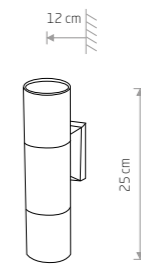

EXE
 painted aluminum, glass
 ■ 8330
 ● 2xGU10, max 35W
 IP54

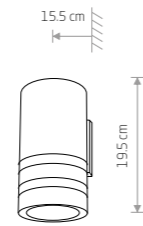

SIERRA
painted aluminum, plastic PC

■ 4421
 1xE27, max 40W
 IP54

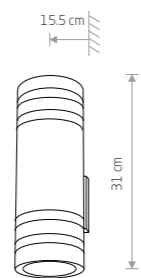

SIERRA
painted aluminum, plastic PC

■ 4422
 2xE27, max 40W
 IP54

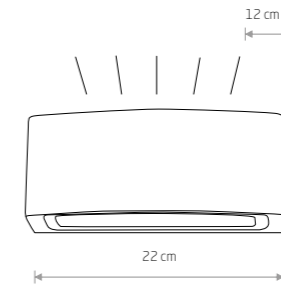

BRICK
painted aluminum, glass

■ 3408
 1xE27, max 60W
 IP65

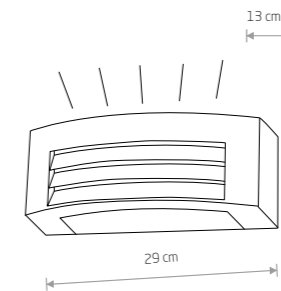

ORINOKO
painted aluminum, plastic PC

■ 4387
 1xE27, max 20W
 IP44

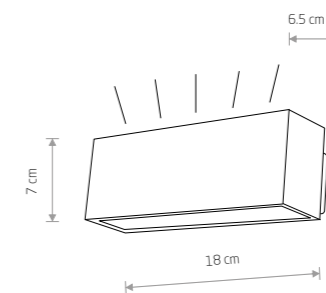

UNIT LED
painted aluminum

■ 9122

Item No.	Power	Colour temp.	Luminous flux	Beam angle	Colour Rendering Index (CRI)	Input	Safety type	Power factor	Ingress protection	Lifetime
9122	2x5W LED	3000K	727 lm	110°	≥ 80	~220-230 V, 50/60 Hz	⊕	>0,89	IP54	20000h

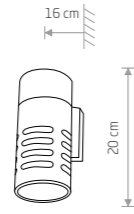

MEKONG

■ painted aluminum, glass

■ 4418

■ 1xE27, max 18W

IP42

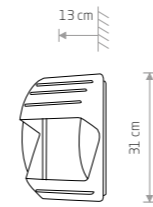

MISTRAL

■ painted aluminum, plastic PC

■ 4390

■ 1xE27, max 23W

IP44

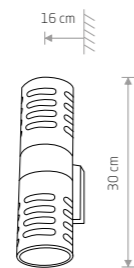

MEKONG

■ painted aluminum, glass

■ 4420

■ 2xE27, max 18W

IP42

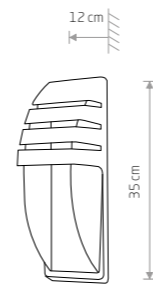

MISTRAL

■ painted aluminum, plastic PC

■ 3393

■ 1xE27, max 23W

IP44

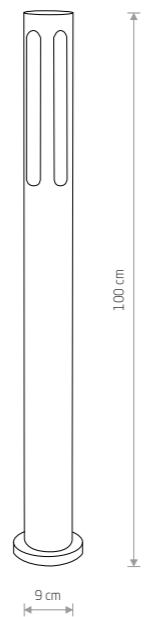

MEKONG

■ painted aluminum, glass

■ 4698

■ 1xE27, max 18W

IP42

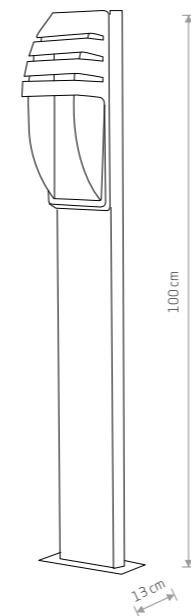

MISTRAL

■ painted aluminum, plastic PC

■ 3394

■ 1xE27, max 23W

IP44



AMUR 4692

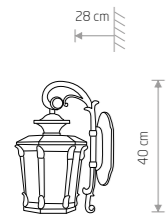

AMUR
painted aluminum, glass

4692
1xE27, max 60W

IP23



AMUR 4693

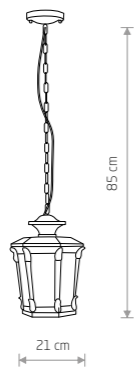

AMUR
painted aluminum, glass

4693
1xE27, max 60W

IP23

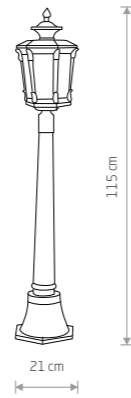

AMUR
painted aluminum, glass

4694
1xE27, max 60W

IP44



TYBR 4684

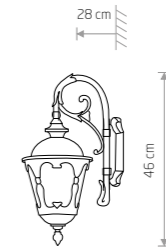

TYBR
painted aluminum, glass

4686
1xE27, max 60W
IP44

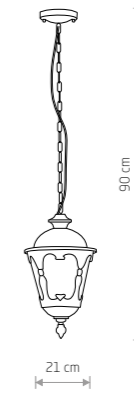

TYBR
painted aluminum, glass

4684
1xE27, max 60W
IP44



TYBR 4685

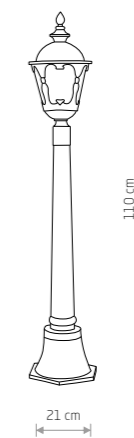

TYBR
painted aluminum, glass

4685
1xE27, max 60W
IP44



TAY 5294

25 cm



36 cm



TAY 5292

TAY

■ painted aluminum, glass

■ 5292

● 1xE27, max 60W

IP23

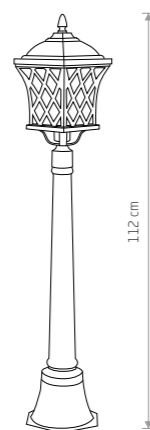

112 cm

18.5 cm

TAY

■ painted aluminum, glass

■ 5294

● 1xE27, max 60W

IP23

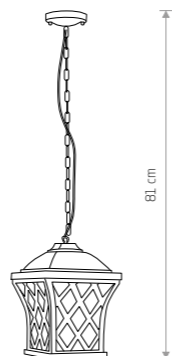

81 cm

18.5 cm

TAY

■ painted aluminum, glass

■ 5293

● 1xE27, max 60W

IP23



SPEY 5290

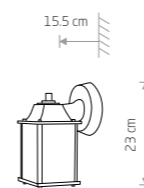

15.5 cm

23 cm

SPEY

■ painted aluminum, glass

■ 5290

● 1xE27, max 60W

IP23



SPEY 5291

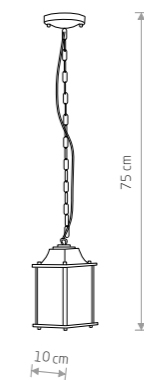

75 cm

10 cm

SPEY

■ painted aluminum, glass

■ 5291

● 1xE27, max 60W

IP23

■ BLACK

■ BLACK

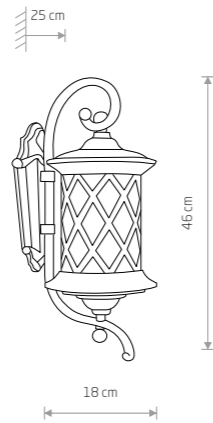

LANTERN

■ painted aluminum, glass

■ 6911

■ 1xE27, max 60W

IP23

QUARTZ

■ painted aluminum, plastic PC

■ 3411

■ 1xE27, max 60W

IP21

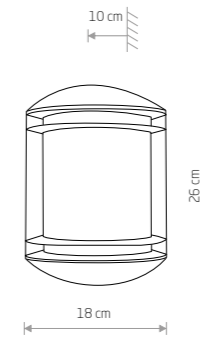

QUARTZ SENSOR 7016

QUARTZ SENSOR

■ painted aluminum, plastic PC

■ 7016

■ 1xE27, max 60W

IP21

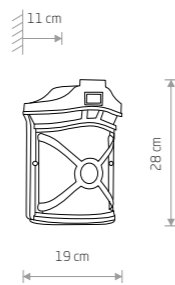
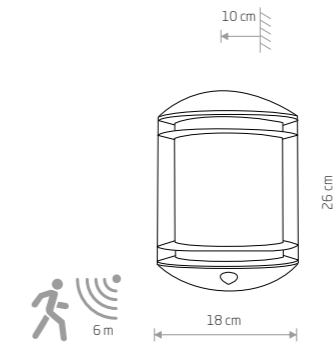

DON

■ painted aluminum, glass

■ 4687

■ 1xE27, max 60W

IP44

INDUS

■ painted aluminum, glass

■ 4440

■ 2xE27, max 15W

IP44

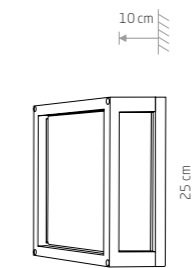



POLE LED 9185

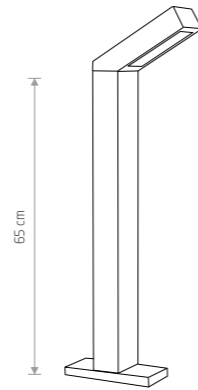

LHOTSE LED
painted aluminum, plastic PC

■ 4448

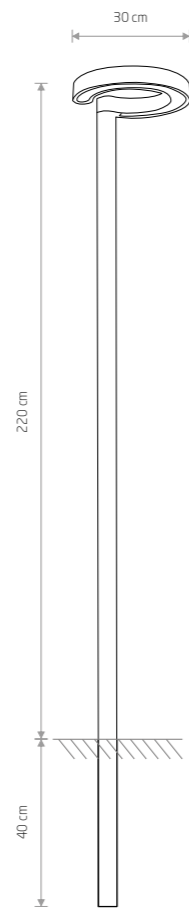

POLE LED
painted aluminum, plastic PC

■ 9185



TEPIC LED
painted aluminum

■ 9508

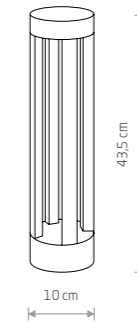

MONTERREY LED
painted aluminum

■ 9507

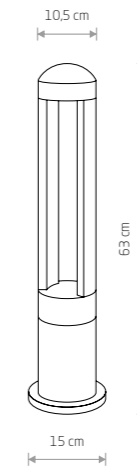

Item No.	Power	Colour temp.	Luminous flux	Beam angle	Colour Rendering Index (CRI)	Input	Safety type	Power factor	Ingress protection	Lifetime
9508	9W LED	3000K	395 lm	31 °	≥ 80	~220-230 V, 50/60 Hz	⊕	>0,85	IP54	10000h
9507	9W LED	3000K	410 lm	39 °	≥ 80	~220-230 V, 50/60 Hz	⊕	>0,85	IP54	10000h
4448	9W LED	3000K	169 lm	72 °	≥ 80	~220-230 V, 50/60 Hz	⊕	>0,79	IP54	10000h
9185	20W LED	3000K	950 lm	54 °	>80	~220-230 V, 50/60 Hz	⊕	>0,94	IP54	30000h

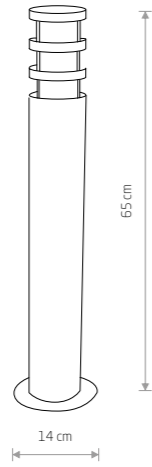

NORIN

■ painted aluminum, glass

■ 4446

● 1xE27, max 20W

IP44

OIR

■ painted aluminum, plastic PC

■ 9158

● 1xE27, max 40W

IP44

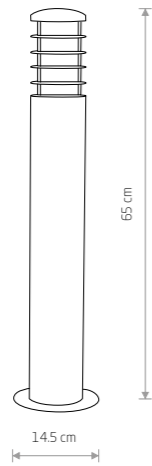
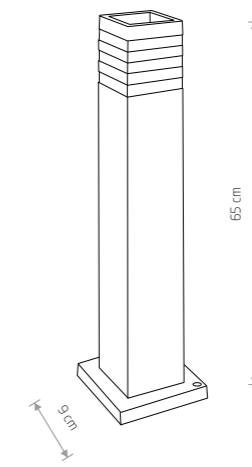

HORN

■ painted aluminum, glass

■ 4906

● 1xE27, max 20W

IP44

SIROCCO

■ aluminum, glass

■ 3396

● 1xE27, max 60W

IP44

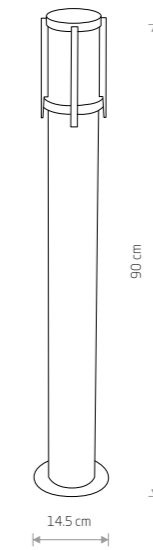



PATHWAY LED M 9252

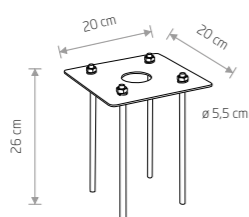

PATHWAY FOUNDATION KIT

steel

8795

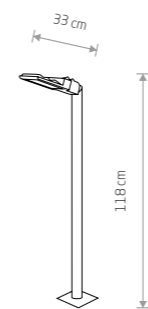

PATHWAY LED S

painting steel, painting aluminum

9420

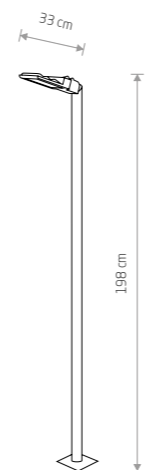

PATHWAY LED M

painting steel, painting aluminum

9252

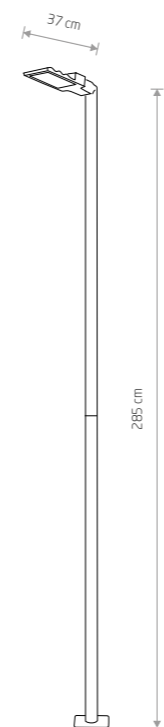

PATHWAY LED L

painting steel, painting aluminum

9125



Item No.	Power	Colour temp.	Luminous flux	Beam angle	Colour Rendering Index (CRI)	Input	Safety type	Power factor	Ingress protection	Lifetime
9420	24W LED	3000K	2200 lm	100°	≥ 80	~220-230 V, 50/60 Hz	⊕	>0,9	IP44	30000h
9252	24W LED	3000K	2200 lm	100°	≥ 80	~220-230 V, 50/60 Hz	⊕	>0,9	IP44	30000h
9125	36W LED	3000K	3600 lm	100°	≥ 80	~220-230 V, 50/60 Hz	⊕	>0,9	IP44	30000h

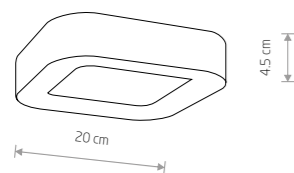

PUEBLA LED
painted aluminum, plastic PC

■ 9513

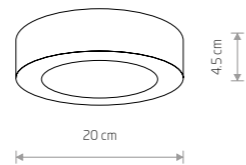

MERIDA LED
painted aluminum, plastic PC

■ 9514



Item No.	Power	Colour temp.	Luminous flux	Beam angle	Colour Rendering Index (CRI)	Input	Safety type	Power factor	Ingress protection	Lifetime
9513	12W LED	3000K	538 lm	110°	≥ 80	~220-230 V, 50/60 Hz	⊕	>0,93	IP54	20000h
9514	12W LED	3000K	538 lm	110°	≥ 80	~220-230 V, 50/60 Hz	⊕	>0,93	IP54	20000h



HEXA 9565

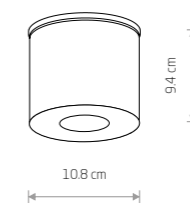

HEXA
painted aluminum, glass

■ 9564 ■ 9565



IP44

EDESSA LED M 9107





LENS LED 9113



LENS LED 9112

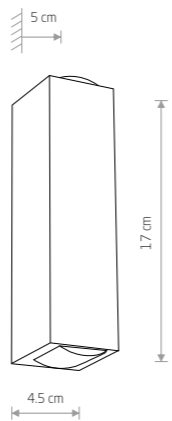

LENS LED
painted aluminum, glass

■ 9112 ■ 9113



EDESA LED M 9108

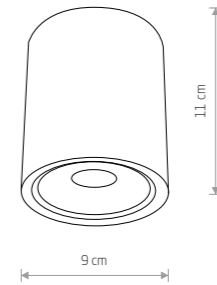

EDESA LED M
painted aluminum, glass

■ 9108 ■ 9107



EDESA LED S 9110

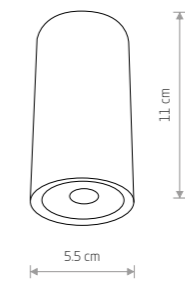

EDESA LED S
painted aluminum, glass

■ 9111 ■ 9110



Item No.	Power	Colour temp.	Luminous flux	Beam angle	Colour Rendering Index (CRI)	Input	Safety type	Power factor	Ingress protection	Lifetime
9112	2x2W LED	3000K	40 lm	10°	≥ 80	~220-230 V, 50/60 Hz	⊕	>0,55	IP54	10000h
9113	2x2W LED	3000K	59 lm	10°	≥ 80	~220-230 V, 50/60 Hz	⊕	>0,55	IP54	10000h
9107	7W LED	3000K	530 lm	68°	≥ 80	~220-230 V, 50/60 Hz	⊕	>0,55	IP54	10000h
9108	6W LED	3000K	460 lm	68°	≥ 80	~220-230 V, 50/60 Hz	⊕	>0,55	IP54	10000h
9110	3W LED	3000K	220 lm	52°	≥ 80	~220-230 V, 50/60 Hz	⊕	>0,55	IP54	10000h
9111	3W LED	3000K	220 lm	52°	≥ 80	~220-230 V, 50/60 Hz	⊕	>0,55	IP54	10000h



NOOK 7965





NOOK 7972



NOOK 7970



NOOK 7978



NOOK 7976



NOOK 7965

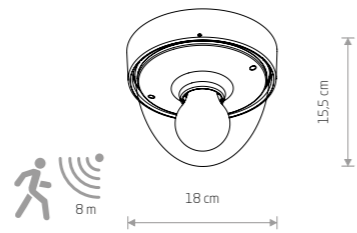
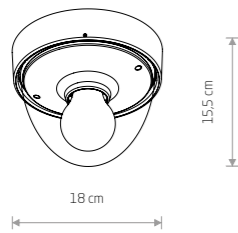

NOOK
plastic ABS, plastic PC

- 7972 7970 7965
- 7976 7978
- 1xE27, max 10W only LED
- IP44

NOOK SENSOR
plastic ABS, plastic PC

- 7971 7968 7964
- 7975 7977
- 1xE27, max 10W only LED
- IP44



TAHOE 7611

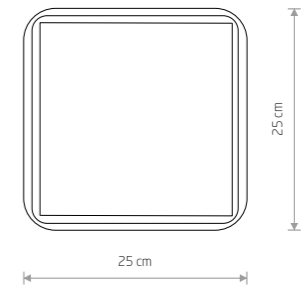

TAHOE
plastic PC, plastic ABS

- 3118 3250
- 1xE27, max 23W
- IP65



TAHOE 3242

TAHOE
plastic PC, plastic ABS

- 3240 3251
- 3242 7611
- 2xE27, max 23W
- IP65



TAHOE 8831

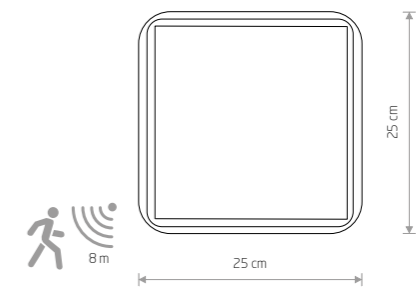

TAHOE SENSOR
plastic PC, plastic ABS

- 8831 8830
- 2xE27, max 23W
- IP65

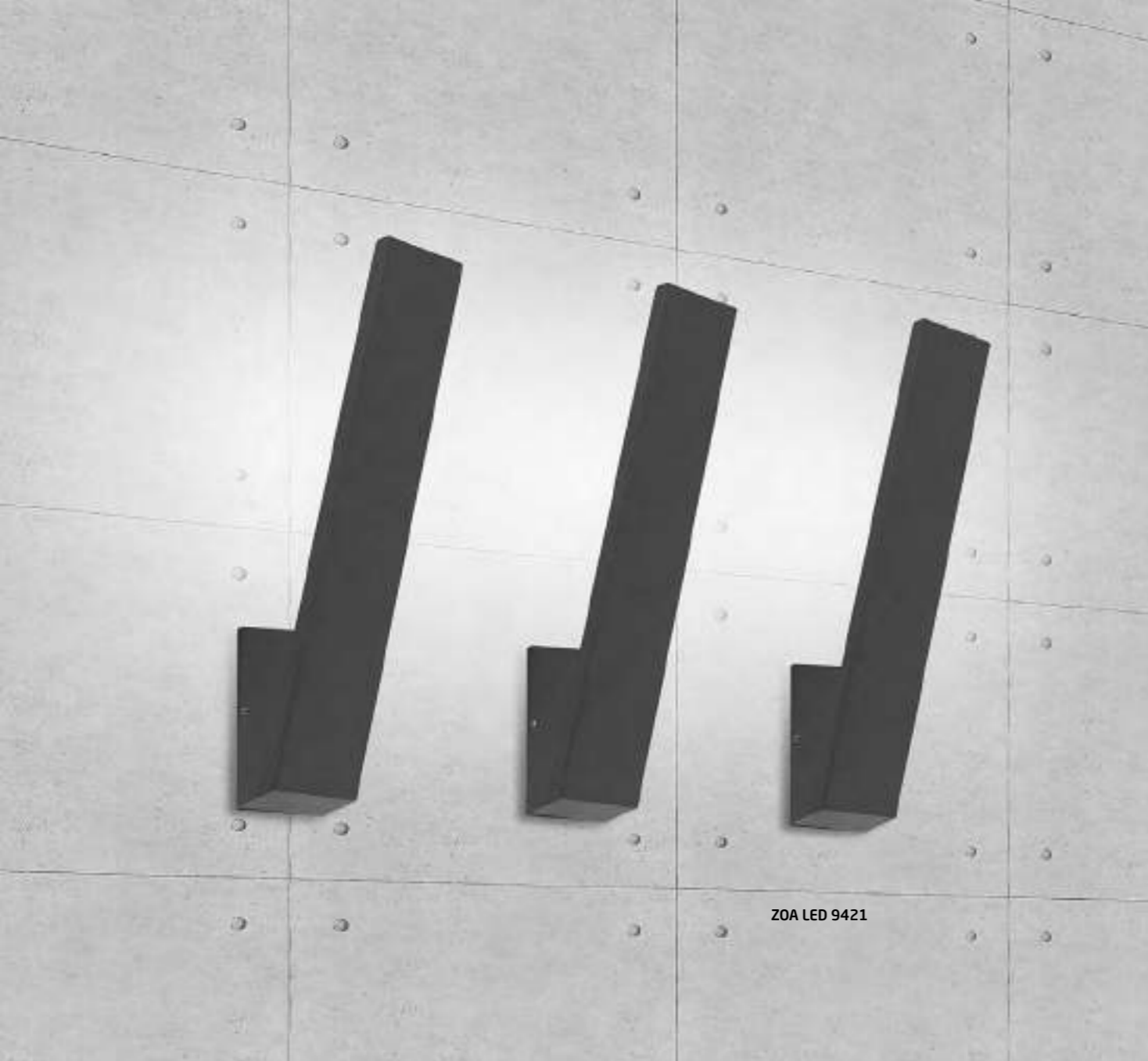

ZOA LED 9421

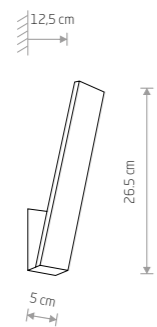

ZOA LED
painted aluminum, glass

■ 9421



Item No.	Power	Colour temp.	Luminous flux	Beam angle	Colour Rendering Index (CRI)	Input	Safety type	Power factor	Ingress protection	Lifetime
9421	10W LED	3000K	795 lm	110°	≥ 81	~220-230 V, 50/60 Hz	⊕	>0,55	IP54	20000h

■ GRAPHITE

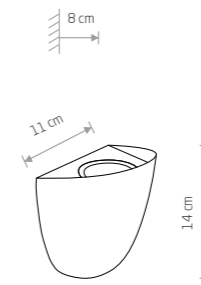

SINUS
painted aluminum, glass

■ 8144

⊕ 1xGU10, max 35W
IP54

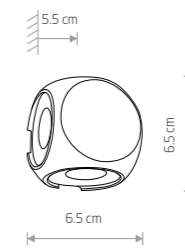

PATRAS LED
painted aluminum, glass

■ 9115

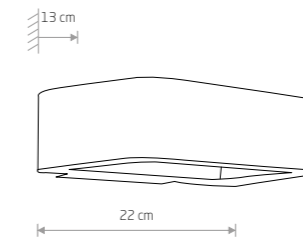

MUNO LED
painted aluminum, glass

■ 6776



Item No.	Power	Colour temp.	Luminous flux	Beam angle	Colour Rendering Index (CRI)	Input	Safety type	Power factor	Ingress protection	Lifetime
9115	4x1W LED	3000K	320 lm	38°	≥ 80	~220-230 V, 50/60 Hz	⊕	>0,55	IP54	10000h
6776	6W LED	3000K	242 lm	120°	≥ 80	~220-230 V, 50/60 Hz	⊕	>0,54	IP54	8000h

■ BLACK

■ GRAPHITE

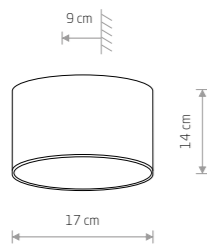

ELLIPSES LED
painted aluminum, glass

8140 8182 8181

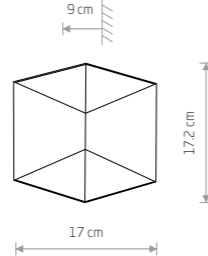

TRIANGLES LED
painted aluminum, glass

8143 8142 8141



LIMA LED
painted aluminum

9510

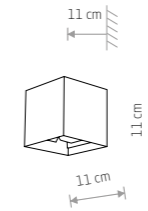

KHUMBU
painted aluminum, glass

4443

1xG9, max 40W

IP44

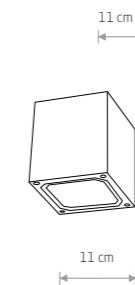

Item No.	Power	Colour temp.	Luminous flux	Beam angle	Colour Rendering Index (CRI)	Input	Safety type	Power factor	Ingress protection	Lifetime
8140	2x5W LED	3000K	800 lm	180°	≥80	~220-230 V, 50/60 Hz	⊕	>0,5	IP54	10000h
8141	2x5W LED	3000K	750 lm	180°	≥80	~220-230 V, 50/60 Hz	⊕	>0,5	IP54	10000h
8142	2x5W LED	3000K	700 lm	180°	≥80	~220-230 V, 50/60 Hz	⊕	>0,5	IP54	10000h
8143	2x5W LED	3000K	800 lm	180°	≥80	~220-230 V, 50/60 Hz	⊕	>0,5	IP54	10000h
8181	2x5W LED	3000K	750 lm	180°	≥80	~220-230 V, 50/60 Hz	⊕	>0,5	IP54	10000h
8182	2x5W LED	3000K	700 lm	180°	≥80	~220-230 V, 50/60 Hz	⊕	>0,5	IP54	10000h

Item No.	Power	Colour temp.	Luminous flux	Beam angle	Colour Rendering Index (CRI)	Input	Safety type	Power factor	Ingress protection	Lifetime
9510	6W LED	3000K	400 lm	97°	≥80	~220-230 V, 50/60 Hz	⊕	>0,55	IP54	10000h

WHITE

BLACK-GOLD

BLACK

WHITE

GRAPHITE

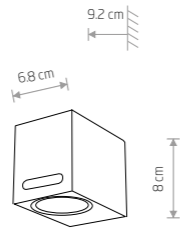

ASSOS
painted aluminum, glass

■ 9123
● 1xGU10, max 10W
IP54

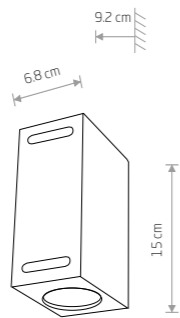

ASSOS
painted aluminum, glass

■ 9124
● 2xGU10, max 10W
IP54

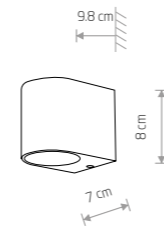

ARRIS
steel, glass

▨ 9516
● 1xGU10, max 10W
IP54

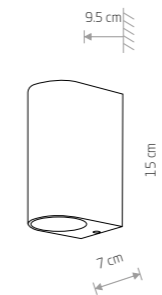

ARRIS
steel, glass

▨ 9515
● 2xGU10, max 10W
IP54

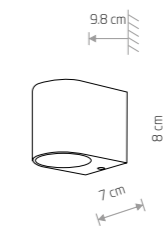

NICO
painted aluminum, glass

■ 9518
● 1xGU10, max 10W
IP54

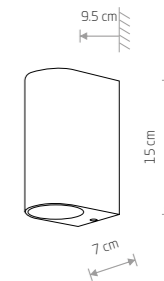

NICO
painted aluminum, glass

■ 9517
● 2xGU10, max 10W
IP54



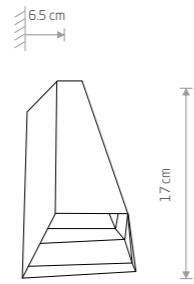

PEAK LED
 painted aluminum, glass
 4441

PRIMM
 painted aluminum, glass
 9551
 1xGU10, max 10W
 IP54

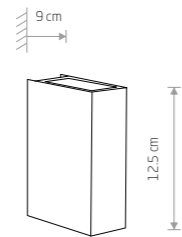
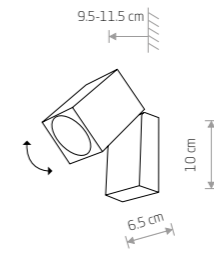

DRAS LED
 painted aluminum, glass
 4442

FALLON
 painted aluminum, glass
 9552
 1xGU10, max 10W
 IP54

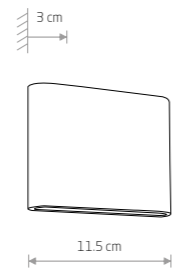
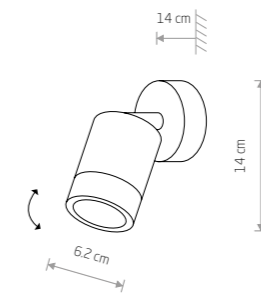

SEMI LED
 painted aluminum, glass
 6775

Item No.	Power	Colour temp.	Luminous flux	Beam angle	Colour Rendering Index (CRI)	Input	Safety type	Power factor	Ingress protection	Lifetime
4441	2x3W LED	3000K	62 lm	83°	≥ 80	~220-230 V, 50/60 Hz	⊕	>0,91	IP54	10000h
4442	2x3W LED	3000K	122 lm	65°	≥ 80	~220-230 V, 50/60 Hz	⊕	>0,91	IP54	10000h
6775	7W LED	3000K	242 lm	120°	≥ 80	~220-230 V, 50/60 Hz	⊕	>0,54	IP54	8000h



BAY LED M 8165

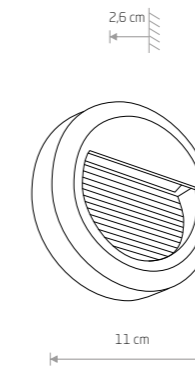

SIDEWALK ROUND LED
painted aluminum, plastic PC

■ 8147

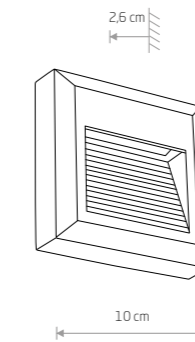

SIDEWALK SQUARE LED
painted aluminum, plastic PC

■ 8148

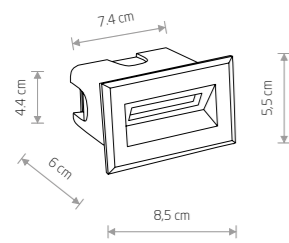

BAY LED
painted aluminum, plastic PC

■ 8164

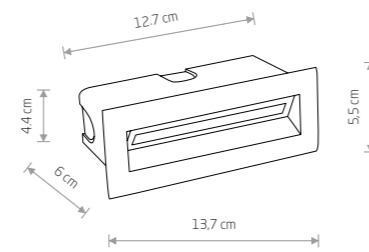

BAY LED
painted aluminum, plastic PC

■ 8165



Item No.	Power	Colour temp.	Luminous flux	Beam angle	Colour Rendering Index (CRI)	Input	Safety type	Power factor	Ingress protection	Lifetime
8164	3W LED	3000K	200 lm	54 °	≥80	~220-230 V, 50/60 Hz	⊕	>0,5	IP65	10000h
8165	5W LED	3000K	360 lm	51 °	≥80	~220-230 V, 50/60 Hz	⊕	>0,5	IP65	10000h

Item No.	Power	Colour temp.	Luminous flux	Beam angle	Colour Rendering Index (CRI)	Input	Safety type	Power factor	Ingress protection	Lifetime
8147	1,6W LED	3000K	61 lm	120 °	≥80	~220-230 V, 50/60 Hz	⊕	>0,5	IP54	20000h
8148	1,6W LED	3000K	61 lm	120 °	≥80	~220-230V V, 50/60 Hz	⊕	>0,5	IP54	20000h

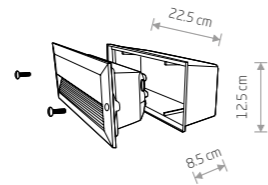

BASALT

■ painted aluminum, plastic

■ 3412 ■ 4966

⚡ 1xE14, max 60W

IP44

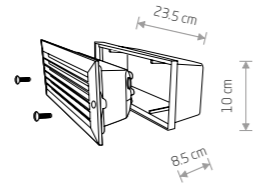

ASSAM

■ painted aluminum, glass, plastic

■ 4453

⚡ 1xE27, max 18W

IP65

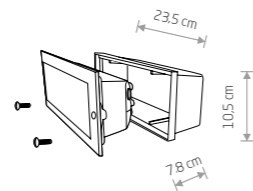

INA

■ painted aluminum, glass, plastic

■ 4907

⚡ 1xE27, max 18W

IP65

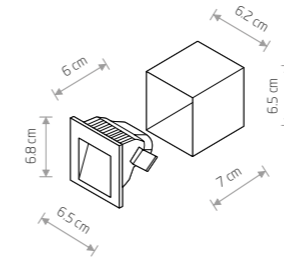

STEP LED

■ painted aluminum, plastic

■ 6907 ■ 6908

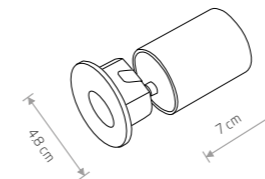

OIA LED

■ painted aluminum, plastic

■ 9102 ■ 9103



⚡ cut out ø 40 mm

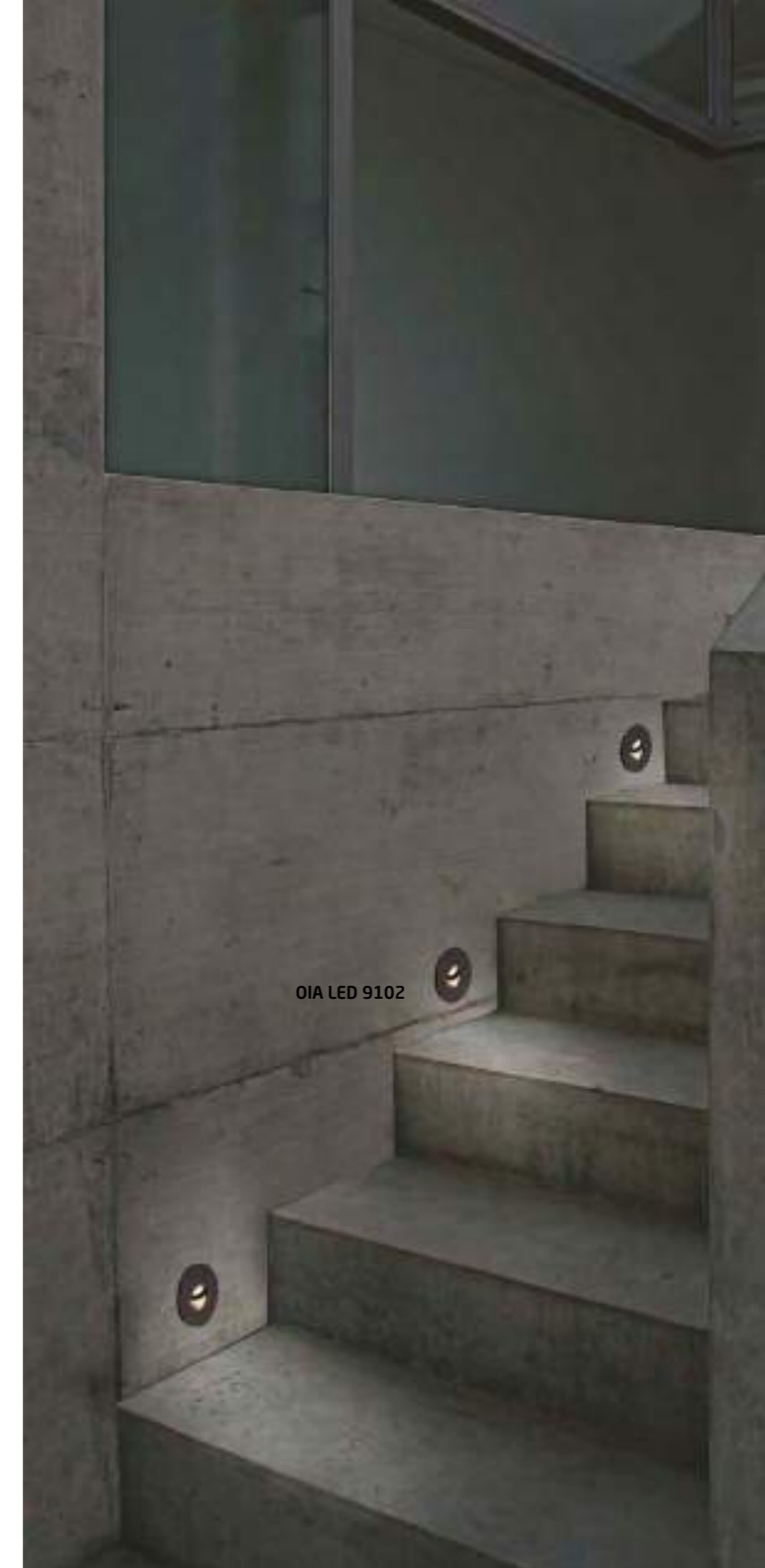

Item No.	Power	Colour temp.	Luminous flux	Beam angle	Colour Rendering Index (CRI)	Input	Safety type	Power factor	Ingress protection	Lifetime
9102 9103	1W LED	3000K	45 lm	49°	≥ 80	~220-230 V, 50/60 Hz	⊕	>0,55	IP20	10000h
6907	3W LED	3000K	120 lm	92°	≥ 80	~220-230 V, 50/60 Hz	⊕	>0,57	IP44	10000h
6908	3W LED	3000K	190 lm	92°	≥ 80	~220-230 V, 50/60 Hz	⊕	>0,57	IP44	10000h

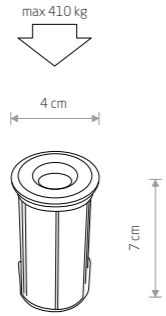

PICCO LED S

aluminum

9106



cut out ø 38 mm

IP67

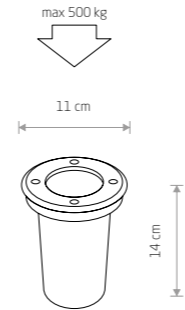

PAOLI

steel, glass

9554

1xGU10, max 10W

cut out ø 100 mm

IP67

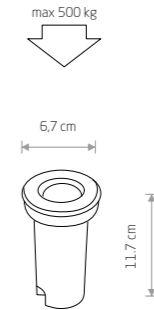

MON LED

aluminum, glass

4454

cut out ø 64 mm

IP67

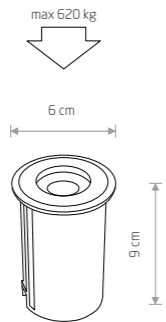

PICCO LED M

aluminum

9105



cut out ø 55 mm

IP67

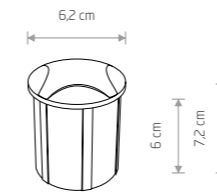

PAT LED

aluminum, plastic PC

8162



cut out ø 56 mm

IP65

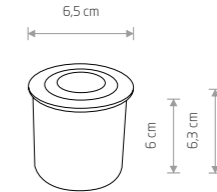

CIRCLET LED

aluminum, plastic PC

8163



cut out ø 57 mm

IP65

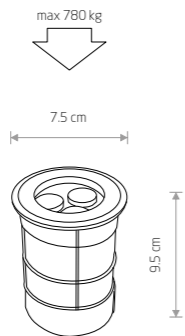

PICCO LED L

aluminum

9104



cut out ø 65 mm

IP67

Item No.	Power	Colour temp.	Luminous flux	Beam angle	Colour Rendering Index (CRI)	Input	Safety type	Power factor	Ingress protection	Lifetime
9106	1W LED	3000K	47 lm	42°	≥ 80	~220-230 V, 50/60 Hz	⊕	>0,55	IP67	10000h
9105	1W LED	3000K	52 lm	51°	≥ 80	~220-230 V, 50/60 Hz	⊕	>0,55	IP67	10000h
9104	3W LED	3000K	130 lm	48°	≥ 80	~220-230 V, 50/60 Hz	⊕	>0,55	IP67	10000h

Item No.	Power	Colour temp.	Luminous flux	Beam angle	Colour Rendering Index (CRI)	Input	Safety type	Power factor	Ingress protection	Lifetime
4454	2W LED	3000K	100 lm	28°	≥ 80	~220-230 V, 50/60 Hz	⊕	>0,42	IP67	10000h
8162	3W LED	3000K	12 lm	25°	≥ 80	~220-230 V, 50/60 Hz	⊕	>0,5	IP65	10000h
8163	3W LED	3000K	120 lm	47°	≥ 80	~220-230 V, 50/60 Hz	⊕	>0,5	IP65	10000h

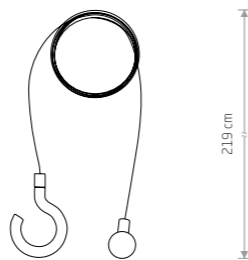

HANGING SET FOR PICNIC LED

aluminum, steel

8107 8106

Lampa bezprzewodowa, przenośna, zewnętrzna

- Podstawa ładowująca w komplecie
- Akumulator litowy 2×2200 mAh
- Czas pełnego ładowania 5-8 h
- Czas pracy 12 h
- Włącznik dotykowy
- Ściemniacz

Wireless lamp, portable, outdoor

- Charging base (set incl.)
- 2×2200 mAh lithium battery
- Full charge time 5-8h
- Work time 12 h
- Touch switch
- Dimmable

Беспроводный светильник, переносной, уличный

- База для зарядки в комплекте
- Литиевая батарея 2×2200 mAh
- Время полной зарядки 5-8 ч
- Рабочее время 12 ч
- Сенсорный выключатель
- Диммер

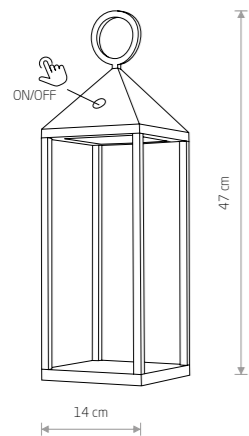

PICNIC LED

painte aluminum, plastic PC

8178 8177



Item No.	Power	Colour temp.	Luminous flux	Beam angle	Colour Rendering Index (CRI)	Input	Safety type	Ingress protection	Lifetime
8177	2,2W LED	3000K	155 lm	46°	≥84	~220-230 V, 50/60 Hz	☐	IP54	30000h
8178	2,2W LED	3000K	155 lm	46°	≥84	~220-230 V, 50/60 Hz	☐	IP54	30000h

WHITE

GRAPHITE





MAHE LED 8397



MAHE LED
painted aluminum, plastic PC

- 8397 8398
-

- Lampa bezprzewodowa, przenośna, zewnętrzna
- Ładowarka MICRO USB (w zestawie)
 - Czas pełnego ładowania 5-7 h
 - Czas pracy 9 h
 - Włącznik dotykowy
 - Ściemniacz

- Wireless lamp, portable, outdoor
- Power adapter MICRO USB (set incl.)
 - Full charge time 5-7 h
 - Work time 9 h
 - Touch switch
 - Dimmable

- Беспроводный светильник, переносной, уличный
- Зарядное устройство MICRO USB (в наборе)
 - Время полной зарядки 5-7 ч
 - Рабочее время 9 ч
 - Сенсорный выключатель
 - Диммер

Item No.	Power	Colour temp.	Luminous flux	Beam angle	Colour Rendering Index (CRI)	Input	Safety type	Ingress protection	Lifetime
8397	2,2W LED	3000K	168 lm	46°	≥ 84	~220-230 V, 50/60 Hz		IP54	25000h
8398	2,2W LED	3000K	168 lm	46°	≥ 84	~220-230 V, 50/60 Hz		IP54	25000h



FASTOON LIGHTS 6 M 7873

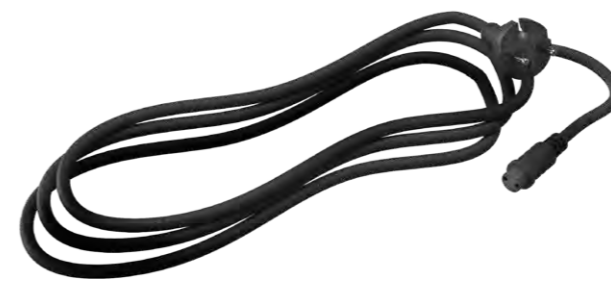

MAX 2000W MAX 80m CONNECTABLE

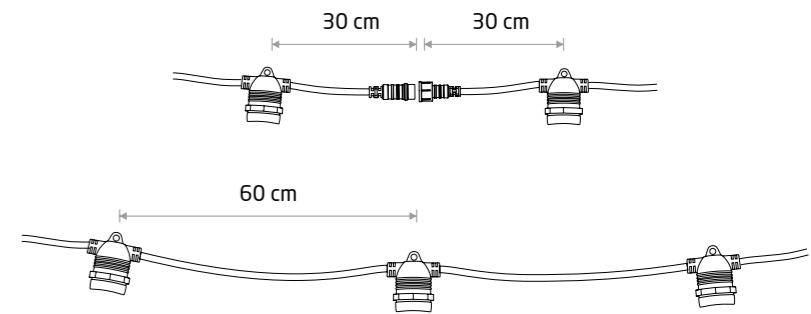
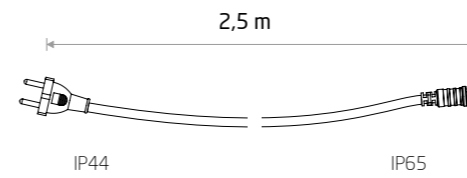

POWER CORD FOR FESTOON LIGHTS
rubber cable

- 7871
- IP65

FESTOON LIGHTS 6M
rubber cable

- 7873
- 10xE27, max 15W
- IP65

FESTOON LIGHTS 9M
rubber cable

- 7872
- 15xE27, max 15W
- IP65



5 PC SET

BULB LED E27, A60 2W, 5 PC SET

- glass
- 7487

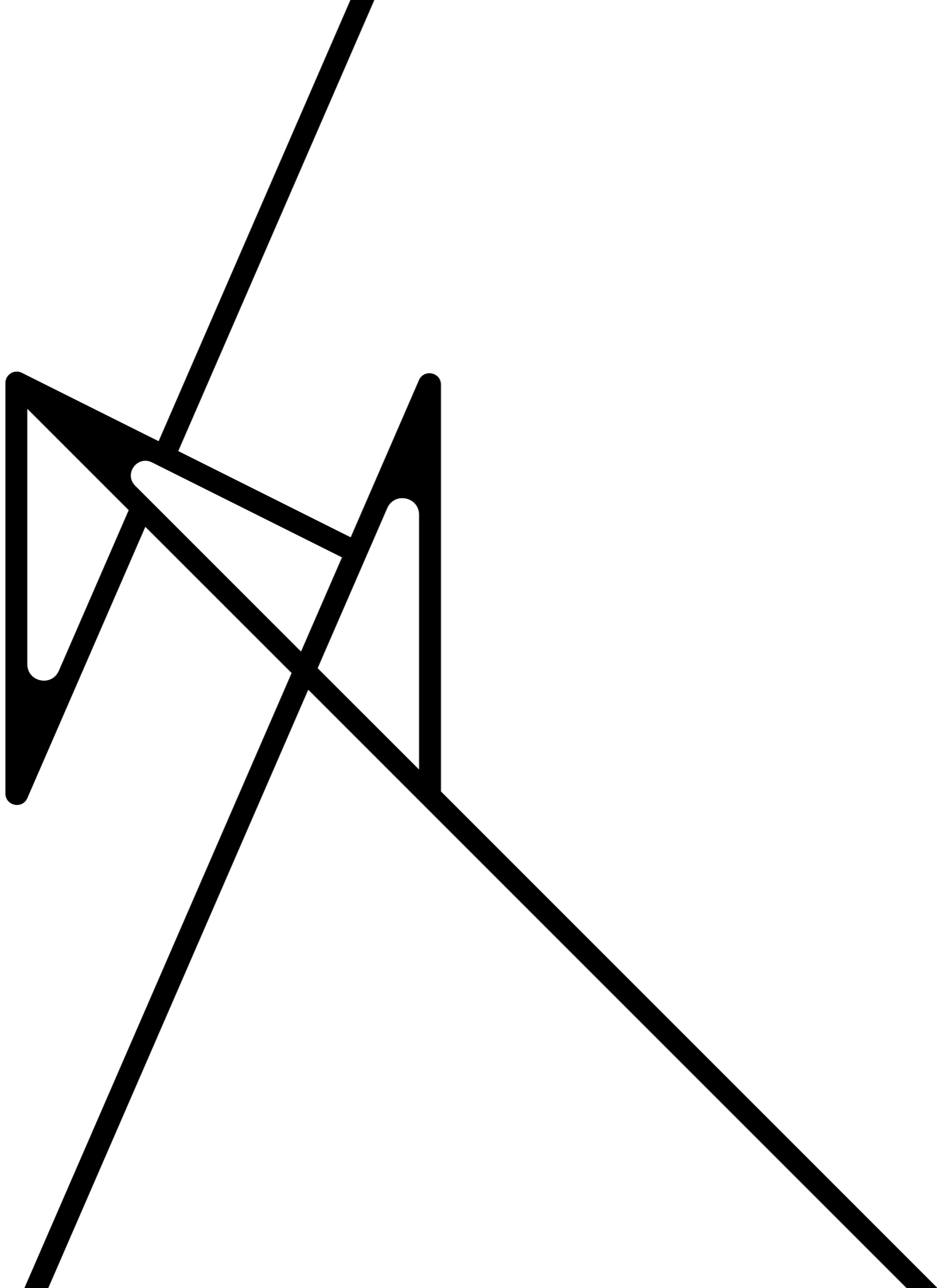

Light sources
and accessories

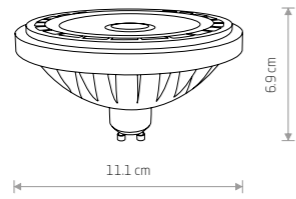

**REFLECTOR COB LED,
GU10 , ES111, 15W**

plastic

9831 4000K

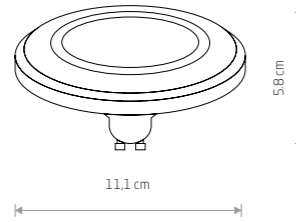

**REFLECTOR LENS LED,
GU10, ES111, 9W**

plastic

9343 3000K 9345 3000K
9213 4000K 9214 4000K

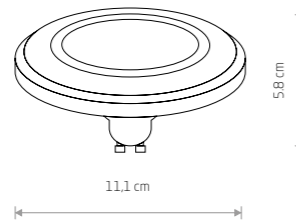

**REFLECTOR DIFFUSER
LED, GU10, ES111, 9W**

plastic

9342 3000K 9344 3000K
9211 4000K 9212 4000K

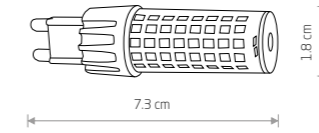

BULB LED G9, 7W

ceramic housing, plastic PC

9197 3000K

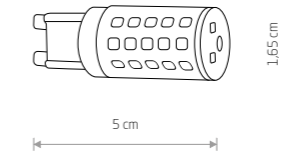

BULB LED G9, 4W

plastic PC

7503 3000K 7504 4000K

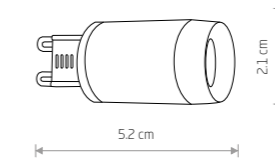

BULB LENS LED, G9, 3W

ceramic housing, plastic PC

9173 3000K 8447 4000K

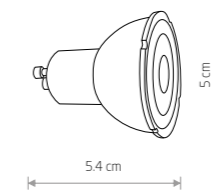

**REFLECTOR LED,
GU10, R50, 7W**

plastic

9180 3000K 8348 3000K
9178 4000K 8347 4000K

Item No.	Power	Colour temp.	Luminous flux	Beam angle	Colour Rendering Index (CRI)	Input	Power factor	Lifetime
9831	15W LED COB	4000K	1200 lm	37°	≥ 80	~220-230 V, 50/60 Hz	>0,5	25000h
9343	9W LED	3000K	770 lm	30°	≥ 80	~220-230 V, 50/60 Hz	>0,5	25000h
9345	9W LED	3000K	870 lm	27°	≥ 80	~220-230 V, 50/60 Hz	>0,5	25000h
9213	9W LED	4000K	870 lm	26°	≥ 80	~220-230 V, 50/60 Hz	>0,5	25000h
9214	9W LED	4000K	930 lm	30°	≥ 80	~220-230 V, 50/60 Hz	>0,5	25000h
9342	9W LED	3000K	660 lm	120°	≥ 80	~220-230 V, 50/60 Hz	>0,5	25000h
9344	9W LED	3000K	700 lm	120°	≥ 80	~220-230 V, 50/60 Hz	>0,5	25000h
9211	9W LED	4000K	680 lm	120°	≥ 80	~220-230 V, 50/60 Hz	>0,5	25000h
9212	9W LED	4000K	730 lm	120°	≥ 80	~220-230 V, 50/60 Hz	>0,5	25000h

Item No.	Power	Colour temp.	Luminous flux	Beam angle	Colour Rendering Index (CRI)	Input	Power factor	Lifetime
9197	7W LED	3000K	750 lm	360°	≥ 80	~220-230 V, 50/60 Hz	>0,5	25000h
7503	4W LED	3000K	380 lm	360°	≥ 80	~220-230 V, 50/60 Hz	>0,4	25000h
7504	4W LED	4000K	390 lm	360°	≥ 80	~220-230 V, 50/60 Hz	>0,4	25000h
9173	3W LED	3000K	330 lm	90°	≥ 80	~220-230 V, 50/60 Hz	>0,5	25000h
8447	3W LED	4000K	310 lm	90°	>80	~220-230 V, 50/60 Hz	>0,5	25000h

WHITE

BLACK

WHITE

BLACK

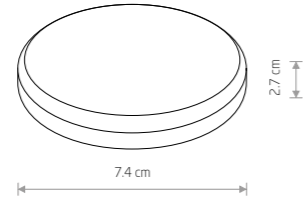

BULB LED GX53, 8W

plastic PC

8377 3000K 8378 4000K

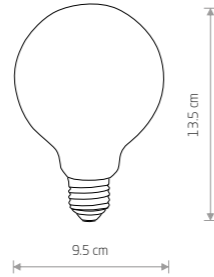

BULB GLASS BALL LED, E27, 8W

glass

9177



5 PC SET

BULB LED E27, A60 2W, 5 PC SET

glass

7487

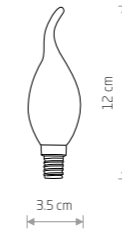

BULB VINTAGE LED E14, 4W

glass

9793

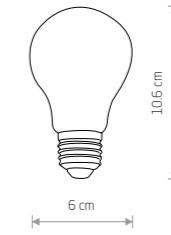

BULB VINTAGE LED E27, 4W

glass

9794

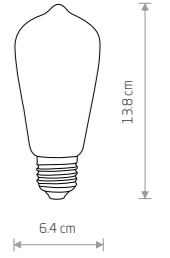

BULB VINTAGE LED E27, 4W

glass

9796

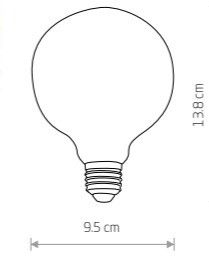

BULB VINTAGE LED E27, 4W

glass

9797

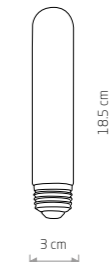

BULB VINTAGE LED E27, 4W

glass

9795

Item No.	Power	Colour temp.	Luminous flux	Beam angle	Colour Rendering Index (CRI)	Input	Power factor	Lifetime
9180	7W LED	3000K	600 lm	39°	≥ 80	~220-230 V, 50/60 Hz	>0.5	25000h
9178	7W LED	4000K	620 lm	50°	≥ 80	~220-230 V, 50/60 Hz	>0.5	25000h
8348	7W LED	3000K	560 lm	41°	≥ 80	~220-230 V, 50/60 Hz	>0.5	25000h
8347	7W LED	4000K	570 lm	40°	≥ 80	~220-230 V, 50/60 Hz	>0.5	25000h
8377	8W LED	3000K	610 lm	100°	>80	~220-230 V, 50/60 Hz	>0.5	25000h
8378	8W LED	4000K	650 lm	100°	>80	~220-230 V, 50/60 Hz	>0.5	25000h
9177	8W LED	3000K	840 lm	360°	≥ 80	~220-230 V, 50/60 Hz	>0.5	25000h
7487	2W LED	2200K	160 lm	360°	≥ 80	~220-230 V, 50/60 Hz	>0.4	15000h

Item No.	Power	Colour temp.	Luminous flux	Beam angle	Colour Rendering Index (CRI)	Input	Replacement	Switch cycles on/off	Lifetime
9793	4W LED	2200K	440 lm	360°	≥ 80	~220-230 V, 50/60 Hz	4W LED=35W	x 15 000	15000h
9794	4W LED	2200K	400 lm	360°	≥ 80	~220-230 V, 50/60 Hz	4W LED=35W	x 15 000	15000h
9796	4W LED	2200K	360 lm	360°	≥ 80	~220-230 V, 50/60 Hz	4W LED=35W	x 15 000	15000h
9797	4W LED	2200K	390 lm	360°	≥ 80	~220-230 V, 50/60 Hz	4W LED=35W	x 15 000	15000h
9795	4W LED	2200K	370 lm	360°	≥ 80	~220-230 V, 50/60 Hz	4W LED=35W	x 15 000	15000h



TUBE LED T8, 11W

glass

7500



TUBE LED T8, 16W

glass

7501



TUBE LED T8, 22W

glass

7502

Item No.	Power	Colour temp.	Leds	Luminous flux	Beam angle	Colour Rendering Index (CRI 2)	Input	Power factor	Lifetime
7500	11W LED	3000K	SMD2835	1700 lm	120°	≥80	~220-230 V, 50/60 Hz	>0,5	30000h
7501	16W LED	3000K	SMD2835	2300 lm	120°	≥80	~220-230 V, 50/60 Hz	>0,5	30000h
7502	22W LED	3000K	SMD2835	3200 lm	120°	≥80	~220-230 V, 50/60 Hz	>0,5	30000h

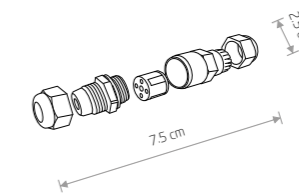

WATERPROOF CONNECTOR IP68

plastic PA

8845

IP68

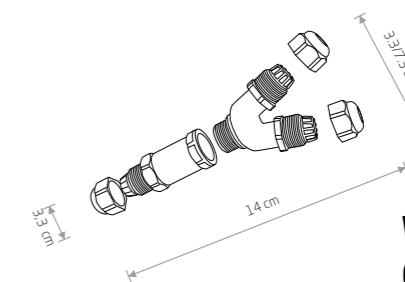

WATERPROOF „Y” CONNECTOR IP68

plastic PA

8846

IP68

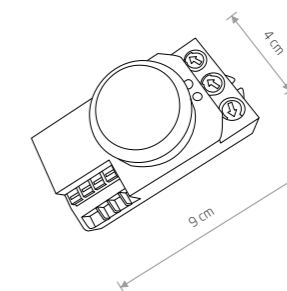

MICROWAVE SENSOR

plastic

8821



DUPLEX

plastic PC

9341

2xE27, max 40W

INFORMACJE DLA KLIENTA / CUSTOMER INFORMATION / ИНФОРМАЦИЯ ДЛЯ КЛИЕНТОВ

Informacje ogólne / General information / Главная Информация

Rzeczywiste parametry produktów mogą się różnić od wartości deklarowanych w katalogu o +/- 10%.
The actual product parameters may differ from the values declared in the catalogue by +/- 10%.
Фактические параметры товаров могут отличаться от заявленных в каталоге значений на +/- 10%.

Zdjęcia prezentowanego asortymentu w niniejszym katalogu mają charakter poglądowy.
Rzeczywisty kolor produktów może nieznacznie odbiegać od prezentowanego na zdjęciach, ze względu na technologię druku.

Photos in this catalogue are for illustrative purposes only.
The actual color of the products may slightly differ from that shown in the photos, due to the printing technology.

Фотографии представленного ассортимента в этом каталоге в качестве иллюстрации.
Фактический цвет продуктов может незначительно отличаться от представленного на фотографиях из-за технологии печати.

Informacje techniczne / Technical information / Техническая информация

Temperatura barwowa (K) - w potocznym rozumieniu, to „kolor” światła białego emitowanego przez źródło, np. źródło LED.
W uproszczeniu możemy podzielić je na światło o:

- barwie ciepłej
- barwie neutralnej
- barwie zimnej

Colour temperature (K) in common understanding is the colour of white light emitted by a source, for example such as an LED source.

In simple terms, we can divide them into:

- Warm white
- White
- Cool white

Цветовая температура (K) в общепринятом понимании - это «цвет» белого света, излучаемого источником, например светодиодом.

Проще говоря, мы можем разделить их на:

- Теплый белый
- Белый
- Холодный белый

2700-3300K

Barwa ciepła
Warm white
Теплый белый

3400-5300K

Barwa neutralna
White
Белый

5400-7000K

Barwa zimna
Cool white
Холодный белый

Strumień świetlny (lm/lumen) - w potocznym rozumieniu, to całkowita moc światła emitowanego z danego źródła światła.

Lumen (lm) - jednostka miary strumienia świetlnego w układzie SI

1 lm = 1 cd·sr

Luminous flux (lm / lumen) - the total power of light emitted from a light source.

Lumen (symbol: lm) - the unit of luminous flux in SI system.

1 lm = 1 cd·sr

Световой поток (лм / люмен) - общая мощность света, излучаемого данным источником света.

Люмен (лм) - единица светового потока в системе SI.

1 lm = 1 cd·sr

Natężenie oświetlenia (lx/luks) - w potocznym rozumieniu, to gęstość strumienia świetlnego padającego na daną powierzchnię.

Luks (lx) - jednostka natężenia oświetlenia w układzie SI.

1 lx = 1 cd·sr / m²

Illuminance (lx / lux) - in common understanding, it is the density of the luminous flux incident on a given surface.

Lux (lx) - a unit of illuminance in the SI system.

1 lx = 1 cd sr / m²

Освещенность (лк / люкс) - плотность светового потока на заданную площадь.

Единица освещенности в системе SI.

1 lx = 1 cd·sr / m²

CRI (od ang. colour rendering index), Ra - wskaźnik oddawania barw charakteryzujący źródło światła, który określa, jak dobrze postrzegane są barwy oświetlonych przedmiotów.

Im wskaźnik ten jest wyższy, tym barwy są lepiej oddawane, a oświetlane przedmioty wyglądają naturalniej.

Wyrażony jest liczbą z przedziału od 0 do 100, gdzie 100 to światło słoneczne.

Minimum wg przepisów w UE dla opraw wewnętrznych to 80.

CRI- is an index of a light source's ability to reveal colours. It determines how well illuminated colours are perceived.

The higher index, the better colour rendering and the illuminated objects look more natural.

It is expressed with a number from 0 to 100, where 100 is a sunlight.

The minimum according to EU regulations for indoor luminaires is 80.

CRI (colour rendering index) Индекс цветопередачи, характеризующий источник света, который определяет, насколько хорошо воспринимаются цвета освещенных объектов. Чем выше этот индекс, тем лучше передаются цвета и освещенные объекты выглядят естественнее.

Он выражается числом от 0 до 100, где 100 - солнечный свет.

Минимальное требование ЕС для светильников для внутреннего освещения - 80.

Stopień ochrony IP / Degree of protection IP / Степень защиты IP

Stopień ochrony jest wyrażony dwoma cyframi. Pierwsza oznacza ochronę przed ciałami stałymi. Druga to ochrona przed cieczami.













Degree of protection is expressed by two figures. The first one stands for protection against solid particles. The second one stands for protection against liquids.

Степень защиты выражается двумя цифрами. Первая цифра относится к защите от твердых веществ, вторая, к защите от жидкостей.

1 cyfra / 1st figure / 1-ая цифра	
IP0...	Brak ochrony / Not protected / Нет защиты
IP1...	Ochrona przed ciałami stałymi większymi niż 50 mm / Protected against solid objects greater than 50 mm / Защита от попадания твердых веществ \varnothing 50 мм
IP2...	Ochrona przed ciałami stałymi większymi niż 12 mm / Protected against solid objects greater than 12 mm / Защита от попадания твердых веществ \varnothing 12 мм
IP3...	Ochrona przed ciałami stałymi większymi niż 2,5 mm / Protected against solid objects greater than 2,5 mm / Защита от попадания твердых веществ \varnothing 2,5 мм
IP4...	Ochrona przed ciałami stałymi większymi niż 1 mm / Protected against solid objects greater than 1 mm / Защита от попадания твердых веществ \varnothing 1 мм
IP5...	Ochrona przed pyłem / Protected against dust infiltration / Защита от попадания пыли
IP6...	Ochrona ryłuszczelna / Totally protected against dust infiltration / Полная защита от попадания пыли

2 cyfra / 2nd figure / 2-ая цифра	
IP...0	Brak ochrony / Not protected / Нет защиты
IP...1	Ochrona przed padającymi kroplami wody / Protected against vertically falling water drops / Защита от попадания капель воды в вертикальном падении
IP...2	Ochrona przed padającymi kroplami wody przy wychyleniu do 15° / Protected against falling water drops up to 15° from the vertical / Защита от попадания капель воды под углом не более 15°
IP...3	Ochrona przed natryskiwaną wodą / Protected against rain / Защита от дождя
IP...4	Ochrona przed bryzgami wody / Protected against splashing water / Защита от брызг воды
IP...5	Ochrona przed strugami wody / Protected against water jets / Защита от струи воды
IP...6	Ochrona przed falami / Protected against powered water jets / Защита от сильной струи воды
IP...7	Ochrona przed zanurzeniem / Protected against temporary immersion / Защита от временного погружения
IP...8	Ochrona przed głębokim zanurzeniem / Protected against continuous immersion / Защита от продолжительного погружения

IKONY / ICONS / ИЗОБРАЖЕНИЯ

 Lampa wisząca / Pendant lamp / Подвесные светильники	 Kinkiet / Wall lamp / Настенные светильники	 Kinkiet podtynkowy / Recessed wall lamp / Встраиваемые настенные светильники
 Lampa sufitowa / Ceiling lamp / Потолочные светильники	 Oświetlenie punktowe / Spotlight / Точечные светильники	 Źródło światła / Light source / Источник света
 Lampa biurkowa / Table lamp / Настольные лампы	 Podtynkowa lampa sufitowa / Recessed ceiling lamp / Встраиваемые потолочные светильники	 Tuba ledowa / Led tube / Светодиодная лампа
 Lampa podłogowa / Floor lamp / Торшеры	 Lampa najazdowa / Overrun lamp / Встраиваемые дорожные светильники	 Wyciąć / Cut out / Вырезать

 Oprawy oznaczone tym symbolem nie wolno okrywać materiałem termoizolacyjnym. Fittings marked with this symbol must not be covered with thermal insulation materials. Светильники, обозначенные этим символом, нельзя покрывать термоизоляционным материалом.

 Klasa ochronna druga oznacza, że oprawa posiada podwójną izolację ochronną, a przewód ochronny (żyła żółto-zielona) nie może być podłączony do oprawy oświetleniowej. Protection class II means that the fittings are equipped with a double protective insulation, and the green and yellow protective conductor must not be connected to the fitting. Второй защитный класс обозначает светильник с двойной защитной изоляцией, а защитный желто-зеленый провод не должен подключаться к светильнику.

 Klasa ochronna pierwsza oznacza, że oprawa musi być podłączona za pomocą przewodu ochronnego (żyła żółto-zielona) do przewodu lub zacisku uziemiającego. Protection class I means that the fitting must be connected with the yellow and green protective conductor to the grounding wire or terminal. Первый защитный класс обозначает, что светильник должен быть подключен с помощью защитного желто-зеленого провода к заземленному проводу или зажиму.

 Klasa ochronna III oznacza, bezpieczeństwo elektryczne gwarantowane przez bardzo niskie zasilanie (poniżej 50 V). Bez uziemienia. Protection class III means, that electrical safety is guaranteed by a very low power supply (less than 50 Volt). No grounding. Класс III электрическая безопасность гарантирована подачей электроэнергии низкого напряжения (меньше чем 50 вольт).

 Oprawy oznaczone tym symbolem wolno instalować wyłącznie na podłożach niepalnych. Fittings marked with this symbol are suitable for installation only on nonflammable surfaces. Светильники, обозначенные этим символом, можно устанавливать только на негорючих поверхностях.

 Zgodność produktów z ukraińskimi normami. Ukrainian standards compliant. Соответствие продукции украинским стандартам.

 Zgodność z normami Unii Europejskiej. EU standards compliant. Соответствие стандартам Европейского Союза.

 Zgodność produktów z normami Euroazjatyckiej Unii Gospodarczej. EAEU standards compliant. Соответствие продукции стандартам Евразийского экономического союза.

 Do użytku zewnętrznego. Interior use only. Для внешнего использования.

 Do wewnętrznego użytku. Exterior use only. Для внутреннего использования.

 Do stosowania wewnątrz i na zewnątrz. Interior and exterior use. Для внутреннего и внешнего использования.

 Zużyte oprawy oświetleniowe są surowcami wtórnymi - nie wolno wyrzucać ich do pojemników na odpady domowe, mogą zawierać substancje niebezpieczne dla zdrowia i życia ludzkiego oraz środowiska. Zgodnie z dyrektywą WEEE 2012/19/UE użytkownik zobowiązany jest do oddania opraw do punktu zbierania zużytego sprzętu, co przyczyni się do ochrony środowiska naturalnego. Used lighting fixtures are recyclable materials - they must not be disposed of in household waste containers as they may contain substances hazardous to human health or life as well as to the natural environment. In accordance with Regulation WEEE 2012/19 /EU, luminaire user is obliged to return a used lighting fixture to a waste appliance collection point, which will contribute to the protection of the natural environment. Исползованные осветительные приборы являются вторсырьем, их нельзя выбрасывать в контейнеры с хозяйственными отходами, потому что они могут содержать в себе вещества, опасные для здоровья и жизни человека, и вредные для окружающей среды. Согласно директиве WEEE 2012/19/UE, потребитель обязан сдать осветительные приборы в пункт сбора использованного оборудования, что положительно влияет на окружающую среду.

Material	Materiał	Материал
Acrylic crystals	Kryształki akrylowe	Акриловые кристаллы
Aluminum	Aluminium	Алюминий
Braided cable	Przewód w oplocie	Плетеный кабель
Brass plated steel	Stal mosiądzowana	Сталь с латунным покрытием
Brushed stainless steel	Stal nierdzewna szczotkowana	Матовая нержавеющая сталь
Ceramic housing	Ceramiczna oprawka	Керамический патрон
Chrome	Chrom	Хром
Chrome plated steel	Stal chromowana	Хромистая сталь
Composite	Kompozyt	Композитный материал
Concrete	Beton architektoniczny	Архитектурный бетон
Copper plated steel	Stal miedziana	Сталь плакированная медью
Crystal	Kryształ	Кристаллы
Fabric	Tkanina	Ткань
Flexible stem	Peszel	Пешель
Glass	Szkło	Стекло
Gypsum	Gips	Гипс
Metallized glass	Szkło metalizowane	Металлизированное стекло
Painted aluminum	Aluminium lakierowane	Окрашенный алюминий
Painted steel	Stal lakierowana	Лакированная сталь
Plastic	Tworzywo sztuczne	Пластик
Plastic ABS	Tworzywo sztuczne ABS	АБС-пластик
Plastic PA	Tworzywo sztuczne PA	РА-пластик
Plastic PC	Tworzywo sztuczne PC	РС-пластик
Plastic PP	Tworzywo sztuczne PP	РР-пластик
Plastic PS	Tworzywo sztuczne PS	РС-пластик
Plastic PC/ABS	Tworzywo sztuczne PC/ABS	РС-АБС-пластик
Plastic PE	Tworzywo sztuczne PE	ПЭ-пластик
Plastic PMMA	Tworzywo sztuczne PMMA	РММА-пластик
Plywood	Sklejka	Фанера
Rubber cable	Przewód gumowy	Резиновый кабель
Silicone	Silikon	Силикон
Solid brass	Lity mosiądz	Твердой латуни
Steel	Stal	Сталь
Velvet	Aksamit	Бархат
Wood	Drewno	Древесина

KODY KOLORÓW / COLOUR CODES / ЦВЕТОВЫЕ КОДЫ



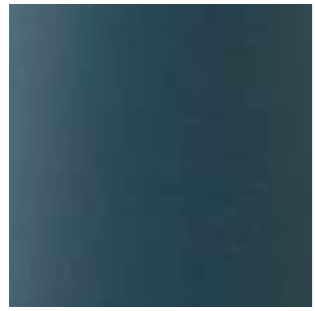

P022



T001

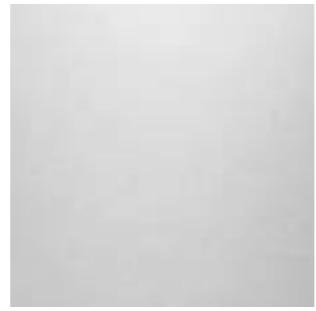

T002



T003

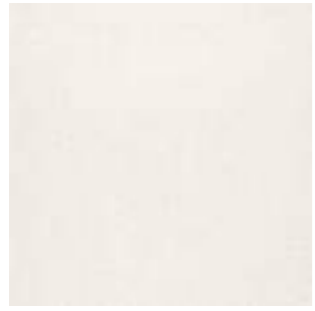

T004



T005



T006



T007



T008



T009



T010



T011



T012



T013



T014



T015



T017



T018



T019



T020

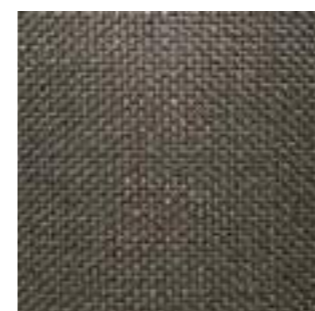

T021



T022



T023



T024

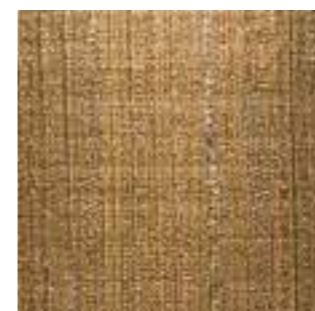

T025

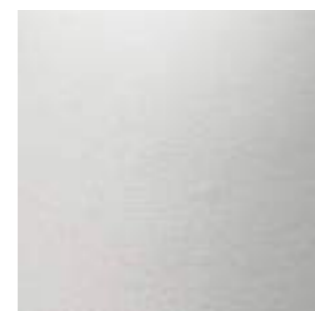

T026



T027



T028



T029



T030



T031

A	CHARLIE.....	392
ABI.....	CHIC LED.....	273
ACROSS.....	CHILLIN.....	124
AGNES LED.....	CIRCLLET LED.....	465
ALICE.....	CL KOS LED.....	337
ALLAN.....	COBA ANTIQUE.....	155
ALPHA.....	COBBLE.....	318
AMALFI.....	CONE.....	101
AMUR.....	COSMO.....	276
ARENA.....	CRAFT.....	211
ARES.....	CRANE.....	64
ARRIS.....	CRATE.....	196
ASSAM.....	CRISTAL.....	88
ASSOS.....	CROCO.....	99
AVEIRO.....	CROSS.....	314
AWINION.....	CUBE.....	258
AXIS.....	CUMULUS CUBE.....	404
	CUMULUS.....	400
	CYLINDER.....	58
B	D	
BALI.....	DALE.....	330
BARREL.....	DELTA.....	392
BASALT.....	DISK.....	151
BASSA LED.....	DON.....	434
BATON.....	DOT.....	335
BAY LED.....	DOVER.....	158
BERGEN.....	DOWNLIGHT ES111.....	331
BIO.....	DRAS LED.....	458
BIT.....	DUPLEX.....	479
BOLD.....	E	
BORDE.....	ECHO.....	393
BOSTON.....	EDESA LED.....	447
BOX ES111.....	EGG.....	223
BRAVO.....	ELLIPSES LED.....	454
BRAZOS.....	EOL LED.....	395
BRICK.....	EXE.....	425
BULB GLASS BALL LED, E27, 8W.....	EYE FIT.....	312
BULB LED, E27, A60, 2W, 5 PC SET.....	EYE FLEX.....	36
BULB LED, G9, 4W.....	EYE.....	28
BULB LED, G9, 7W.....	EYE MOD.....	334
BULB LED, GX53 8W.....	EYE SPOT.....	310
BULB LENS LED, G9, 3W.....	EYE SUPER.....	38
BULB VINTAGE LED.....	EYE TONE.....	325
BULLET.....	EYE WALL.....	34
BUSH.....	F	
C	FALCON.....	108
CABLE.....	FALLON.....	459
CADILAC.....	FARO.....	128
CAGE.....	FESTOON LIGHTS.....	471
CAMERON.....	FIORD.....	184
CAMILLA.....	FLEA.....	322
CANOE.....		
CAYO.....		
CELTIC.....		

FLEX SHADE.....	116
FLEX.....	117
FLOWERPOT.....	402
FOG.....	423
FORM.....	103
FOXTROT.....	394

G	
GALAXY.....	405
GAP.....	318
GARRET.....	215
GEOMETRIC.....	190
GESS LED.....	259
GIOTTO LED.....	245
GIPSY.....	192
GLOBE PLUS.....	72
GOLF.....	393
GROOVE.....	319
GSTAR.....	232

H	
H LED.....	251
HAGA.....	260
HALO.....	320
HAMPTON.....	87
HANGING SET FOR PICNIC LED.....	466
HARMONY.....	212
HAWK.....	109
HELIOS LED.....	395
HEMISPHERE HIT.....	219
HEMISPHERE.....	220
HEMISPHERE RUST.....	216
HERMANOS.....	202
HEXA.....	443
HIGH-BAY.....	213
HORN.....	438
HOTEL.....	120
HOTEL PLUS.....	123

I	
ICE BALL.....	383
ICE EGG.....	364
ICE TUBE LED.....	380
IKA.....	156
IMBRIA.....	49
IMPULSE LED.....	246
INA.....	462
INDIA.....	323
INDUS.....	435
ION LED.....	257
IRIS LED.....	313

J	
JULIET.....	395

K	
KAGERA LED.....	371
KAREN.....	234
KASAI.....	267
KATERINA.....	90
KHUMBU.....	455

L	
LAGUNA.....	92
LANTERN.....	434
LASER.....	22
LATH LED.....	370
LAVA.....	191
LENS LED.....	446
LHOTSE LED.....	436
LIA LED.....	259
LIMA LED.....	455
LUKSOR.....	228

M	
MAHE LED.....	469
MALAKKA LED.....	385
MALMO.....	261
MALWI.....	282
MANUFACTURE.....	180
MARGARET.....	238
MEKNES.....	236
MEKONG.....	428
MERIDA LED.....	442
MERSEY.....	236
MICROWAVE SENSOR.....	479
MIKE.....	323
MILL.....	179
MINIMAL.....	150
MIST.....	102
MISTRAL.....	429
MOD PLUS.....	333
MOD.....	333
MODENA.....	91
MON LED.....	465
MONACO.....	64
MONO.....	288
MONO CORNER.....	293
MONO LONG.....	296
MONO SURFACE.....	300
MONTERREY LED.....	437
MORE EYE.....	46
MORE TONE.....	47
MOSS.....	119
MUNO LED.....	453

N

NARWIK	261
NEGRO	424
NESS	235
NEWPORT	82
NICO	457
NOOK	450
NORIN	438
NUAGE	76
NUNTUCET	81

O

OIA LED	463
OIR	439
ORBIT	162
ORGANIC	265
ORINOKO	427
OSLO LED	152
OTTAWA	410
OVAL	319

P

PAG	318
PAN LED	373
PANTOGRAPH	210
PAOLI	465
PAT LED	465
PATHWAY FOUNDATION KIT	440
PATHWAY LED	441
PATRAS LED	453
PEAK LED	458
PEAR	56
PERM	207
PETIT	132
PICASSO LED	370
PICCO LED	464
PICNIC LED	466
PICO	231
PILE	178
PILLS	164
PIN LED	366
PLANE	281
PLANT	199
POCATELLO	275
POINT	329
POINT PLEXI	328
POINT TONE	322
POLARIS	70
POLE LED	436
POLY	52
POWER CORD FOR FESTOON LIGHTS	471
PRIMM	459
PROFILE BIT PLUS	353

PROFILE BIT	351
PROFILE DEAD END CAP	357
PROFILE EYE FLEX	350
PROFILE EYE SPOT	353
PROFILE EYE SUPER	350
PROFILE EYE	351
PROFILE FLEX CONNECTOR	356
PROFILE FOCUS LED	346
PROFILE INDIA	346
PROFILE IRIS LED	342
PROFILE L CONNECTOR	357
PROFILE MIKE	346
PROFILE POWER END CAP	357
PROFILE POWER SUPPLY KIT	354
PROFILE RECESSED DEAD END CAP	361
PROFILE RECESSED FIXING SET	361
PROFILE RECESSED FLEX CONNECTOR	360
PROFILE RECESSED L CONNECTOR	361
PROFILE RECESSED POWER END CAP	361
PROFILE RECESSED STRAIGHT CONNECTOR	360
PROFILE RECESSED T CONNECTOR	361
PROFILE RECESSED TRACK	358
PROFILE RECESSED X CONNECTOR	361
PROFILE STORE PRO LED	344
PROFILE STRAIGHT CONNECTOR	356
PROFILE SUSPENSION KIT	354
ROFILE T CONNECTOR	357
PROFILE TRACK	354
PROFILE VESPA	353
PROFILE WORKSHOP	351
PROFILE X CONNECTOR	357
PROFILE ZOOM LED	347
PUEBLA LED	442
PUZZLE	280

Q

QUARTZ	435
QUEBECK	53

R

RADIUS	166
REFLECTOR COB LED, GU10 ES111, 15W	474
REFLECTOR LED, GU10, R50, 7W	475
REFLECTOR DIFFUSER LED, GU10, ES111, 9W	474
REFLECTOR LENS LED, GU10, ES111, 9W	474
REMBRANT LED	244
RETTO C	118
RING LED	263
RIO	420
ROCK	422
ROCKET	138
ROD	176
ROTOR	170

S

SALVA	74
SEMI LED	458
SET	324
SHY	195
SHY	190
SIDEWALK LED	461
SIERRA	426
SILICONE	189
SIMI	379
SINUS	453
SIROCCO	439
SIS	375
SMART LED	272
SOFT LED	253
SOLID	194
SOUL	411
SPEY	433
SPHERE	60
SPIDER	186
SPIKE LED	416
STALACTITE	27
STAR	405
STEP LED	463
STICKS	172
STRAIGHT CEILING LED	248
STRAIGHT WALL LED	250
STRUCTURE LED	406
STYLE LED	270
SUN LED	145
SUNRISE LED	142
SUNSET	143
SYMMETRY LED	409

T

TAHOE	451
TAY	432
TECHNO	208
TEPIC LED	437
TESALLI	83
THIKA LED	419
TORCH	383
TOSCANA	91
TRIANGLES LED	454
TRIFLE	136
TUBE LED T8	478
TUBE	259
TUBINGS	415
TULUM	189
TURDA	94
TWIG	185
TWIST	240
TYBR	431

U

UMBRELLA	234
UNIT LED	427

V

VAN GOGH LED	368
VELERO	128
VESPA	315
VETRO	66
VIOLET	107
VIPER	110
VISTA	372
VIVIANE	106
VOLCANO	191

W

WATERPROOF CONNECTOR IP68	479
WAVE	229
WHEEL LUX	149
WHEEL	148
WING LED	256
WORKS	218
WORKSHOP	182

Z

ZELDA	137
ZENITH	204
ZOA LED	452

INDEKS LAMP / PROGRESSIVE CODE INDEX / ИНДЕКС СВЕТИЛЬНИКОВ

INDEX	STRONA PAGE СТРАНИЦА	INDEX	STRONA PAGE СТРАНИЦА	INDEX	STRONA PAGE СТРАНИЦА	INDEX	STRONA PAGE СТРАНИЦА
202	239	3412	462	4653	83	5210	90
203	239	3457	113	4684	431	5211	90
204	239	3458	113	4685	431	5255	32
205	239	3464	113	4686	431	5256	32
206	239	3466	113	4687	434	5257	32
2206	192	4013	91	4692	430	5266	258
2207	192	4014	91	4693	430	5267	258
2208	192	4171	156	4694	430	5272	258
2410	193	4173	156	4698	428	5290	433
2411	193	4174	156	4730	121	5291	433
2763	241	4387	427	4731	121	5292	432
2764	241	4390	429	4838	220	5293	432
2766	241	4418	428	4840	220	5294	432
2767	240	4420	428	4841	221	5295	236
3118	451	4421	426	4842	220	5296	236
3240	451	4422	426	4843	220	5297	236
3242	451	4423	420	4844	220	5298	236
3250	451	4424	420	4856	221	5383	115
3251	451	4425	424	4893	220	5384	115
3346	377	4426	424	4906	438	5386	115
3347	377	4440	435	4907	462	5397	28
3382	276	4441	458	4917	276	5398	28
3393	429	4442	458	4961	112	5400	28
3394	429	4443	455	4962	112	5403	53
3396	439	4446	438	4963	112	5404	53
3401	417	4448	436	4966	462	5405	53
3402	423	4453	462	4981	241	5406	53
3403	423	4454	465	4983	241	5410	237
3404	423	4607	234	4984	241	5411	237
3405	422	4610	234	4985	240	5422	74
3406	422	4611	234	5067	213	5424	74
3407	422	4650	83	5125	237	5428	74
3408	427	4651	83	5126	237	5455	28
3411	435	4652	83	5208	90	5456	28

INDEKS LAMP / PROGRESSIVE CODE INDEX / ИНДЕКС СВЕТИЛЬНИКОВ

INDEX	STRONA PAGE СТРАНИЦА	INDEX	STRONA PAGE СТРАНИЦА	INDEX	STRONA PAGE СТРАНИЦА	INDEX	STRONA PAGE СТРАНИЦА
5463	32	6141	311	6498	42	6770	386
5464	32	6267	172	6500	38	6771	386
5471	32	6268	172	6501	41	6772	106
5472	32	6270	172	6502	41	6773	106
5654	37	6327	282	6503	41	6774	106
5655	37	6330	238	6504	42	6775	458
5663	113	6333	157	6505	42	6776	453
5723	115	6335	182	6506	38	6777	219
5794	275	6336	182	6510	218	6778	219
5795	275	6337	182	6512	110	6785	186
5796	275	6345	250	6513	110	6788	186
5797	275	6350	250	6525	328	6792	186
5798	275	6354	250	6526	328	6800	121
5828	275	6367	216	6527	328	6812	115
5844	311	6368	216	6528	328	6815	115
6000	329	6384	280	6530	328	6816	115
6001	329	6390	106	6532	106	6817	114
6006	329	6391	106	6541	109	6818	115
6007	329	6403	189	6605	182	6820	118
6010	137	6404	189	6606	182	6836	32
6014	310	6442	215	6607	311	6837	32
6015	310	6443	215	6608	311	6838	32
6016	311	6444	215	6610	311	6840	28
6017	311	6481	29	6611	311	6841	28
6018	310	6487	41	6612	218	6842	37
6020	310	6488	41	6613	218	6844	235
6021	311	6490	41	6640	110	6845	75
6022	311	6491	42	6641	110	6846	75
6134	310	6492	42	6724	386	6852	191
6135	310	6493	38	6725	386	6853	191
6136	311	6494	41	6726	386	6855	191
6137	311	6495	41	6727	386	6868	212
6138	310	6496	41	6767	235	6902	281
6140	310	6497	42	6768	235	6903	281

INDEKS LAMP / PROGRESSIVE CODE INDEX / ИНДЕКС СВЕТИЛЬНИКОВ

INDEX	STRONA PAGE СТРАНИЦА	INDEX	STRONA PAGE СТРАНИЦА	INDEX	STRONA PAGE СТРАНИЦА	INDEX	STRONA PAGE СТРАНИЦА
6904	281	7524	254	7564	250	7633	88
6907	463	7525	253	7565	250	7634	263
6908	463	7526	254	7566	250	7635	263
6911	434	7527	254	7567	250	7636	263
6912	259	7528	255	7568	250	7637	263
6913	259	7530	254	7594	250	7638	263
6927	139	7531	254	7595	250	7640	263
6941	235	7532	253	7596	250	7641	66
6948	378	7533	254	7602	329	7642	66
6950	378	7534	255	7603	329	7643	151
6951	378	7535	253	7605	72	7644	151
6976	400	7536	254	7606	72	7645	151
6977	400	7537	253	7607	72	7646	149
6978	400	7538	254	7610	46	7647	145
7016	435	7540	254	7611	451	7648	331
7017	420	7541	255	7612	330	7650	331
7021	78	7542	254	7613	330	7651	145
7022	78	7543	256	7614	89	7652	142
7024	76	7544	254	7615	89	7653	143
7025	76	7545	253	7616	88	7654	143
7026	76	7546	254	7617	88	7655	143
7027	77	7547	253	7618	346	7656	346
7487	476	7548	255	7620	346	7657	346
7487	471	7550	256	7621	346	7658	323
7500	478	7551	248	7622	346	7660	323
7501	478	7552	248	7623	347	7661	346
7502	478	7553	248	7624	347	7662	346
7503	475	7556	248	7625	347	7663	395
7504	475	7557	248	7626	347	7664	395
7517	152	7558	248	7627	88	7665	326
7518	152	7560	250	7628	88	7666	326
7520	153	7561	250	7630	89	7667	23
7521	152	7562	250	7631	89	7668	23
7522	153	7563	250	7632	88	7670	296

INDEKS LAMP / PROGRESSIVE CODE INDEX / ИНДЕКС СВЕТИЛЬНИКОВ

INDEX	STRONA PAGE СТРАНИЦА	INDEX	STRONA PAGE СТРАНИЦА	INDEX	STRONA PAGE СТРАНИЦА	INDEX	STRONA PAGE СТРАНИЦА
7671	296	7708	306	7746	303	7784	289
7672	296	7710	307	7747	303	7785	292
7673	296	7711	307	7748	303	7786	299
7674	296	7712	306	7750	292	7787	299
7675	296	7713	307	7751	293	7788	61
7676	304	7714	307	7752	292	7790	318
7677	304	7715	306	7753	293	7791	318
7678	304	7716	307	7754	292	7792	318
7680	304	7717	307	7755	293	7793	318
7681	304	7718	306	7756	292	7794	57
7682	304	7720	292	7757	293	7795	232
7683	300	7721	293	7758	136	7796	232
7684	300	7722	292	7760	136	7797	56
7685	303	7723	293	7761	136	7798	56
7686	303	7724	296	7762	166	7800	56
7687	303	7725	296	7763	288	7801	162
7688	300	7726	296	7764	299	7802	162
7690	300	7727	296	7765	299	7803	162
7691	303	7728	296	7766	288	7804	162
7692	303	7730	296	7767	289	7805	162
7693	303	7731	296	7768	289	7806	162
7694	292	7732	296	7770	292	7807	288
7695	293	7733	296	7771	288	7808	299
7696	292	7734	304	7772	299	7810	288
7697	293	7735	304	7773	299	7811	289
7698	292	7736	304	7774	288	7812	289
7700	293	7737	304	7775	289	7813	292
7701	292	7738	304	7776	289	7814	47
7702	293	7740	304	7777	292	7816	47
7703	307	7741	304	7778	288	7817	47
7704	307	7742	304	7780	299	7821	47
7705	306	7743	304	7781	299	7822	46
7706	307	7744	300	7782	288	7824	46
7707	307	7745	300	7783	289	7825	46

INDEKS LAMP / PROGRESSIVE CODE INDEX / ИНДЕКС СВЕТИЛЬНИКОВ

INDEX	STRONA PAGE СТРАНИЦА	INDEX	STRONA PAGE СТРАНИЦА	INDEX	STRONA PAGE СТРАНИЦА	INDEX	STRONA PAGE СТРАНИЦА
7826	46	7866	58	7960	107	8030	203
7827	300	7867	58	7961	107	8031	203
7828	300	7868	58	7964	450	8032	203
7830	303	7870	58	7965	450	8033	203
7831	303	7871	471	7968	450	8037	202
7832	303	7872	471	7970	450	8038	202
7833	300	7873	471	7971	450	8040	202
7834	300	7926	224	7972	450	8041	128
7835	303	7927	224	7975	450	8042	128
7836	303	7928	166	7976	450	8043	128
7837	303	7930	166	7977	450	8044	127
7838	288	7931	167	7978	450	8045	127
7840	299	7932	167	7982	128	8046	127
7841	288	7933	170	7983	128	8047	26
7842	289	7934	170	7984	128	8048	26
7843	289	7935	171	7985	127	8050	372
7844	292	7936	170	7986	127	8051	372
7846	60	7937	171	7987	127	8052	379
7847	60	7938	162	7988	134	8053	376
7848	60	7941	163	7990	134	8054	375
7850	60	7942	163	7991	135	8055	374
7851	50	7943	162	7992	135	8056	379
7852	50	7945	163	7993	35	8057	379
7853	51	7946	163	7994	35	8072	34
7854	51	7948	108	7995	35	8073	34
7855	50	7950	108	7996	204	8074	34
7856	50	7951	108	7997	204	8075	136
7857	353	7952	267	7998	204	8076	136
7858	323	7953	386	8001	204	8077	136
7860	323	7954	49	8002	204	8078	136
7862	29	7955	49	8003	204	8080	136
7863	29	7956	49	8005	204	8086	326
7864	58	7957	49	8006	204	8087	326
7865	58	7958	107	8007	204	8088	326

INDEKS LAMP / PROGRESSIVE CODE INDEX / ИНДЕКС СВЕТИЛЬНИКОВ

INDEX	STRONA PAGE СТРАНИЦА	INDEX	STRONA PAGE СТРАНИЦА	INDEX	STRONA PAGE СТРАНИЦА	INDEX	STRONA PAGE СТРАНИЦА
8091	326	8138	269	8176	409	8221	322
8092	326	8140	454	8177	466	8222	322
8093	326	8141	454	8180	409	8223	322
8100	202	8142	454	8181	454	8224	322
8103	202	8143	454	8182	454	8225	322
8106	466	8144	453	8183	268	8226	133
8107	466	8145	406	8184	268	8262	165
8108	269	8146	406	8185	268	8263	165
8110	269	8147	461	8186	268	8264	164
8111	269	8148	461	8187	268	8265	164
8112	269	8150	81	8188	268	8266	164
8113	269	8151	81	8190	134	8267	165
8114	269	8152	86	8191	135	8268	165
8115	247	8153	86	8194	202	8270	164
8116	246	8154	87	8195	320	8271	164
8117	246	8155	87	8196	320	8272	164
8118	381	8156	82	8197	124	8273	386
8120	381	8157	82	8198	124	8274	386
8121	380	8158	415	8200	124	8285	232
8122	380	8160	415	8201	124	8302	265
8123	383	8161	415	8202	322	8303	265
8124	364	8162	465	8203	322	8304	265
8125	364	8163	465	8204	268	8305	265
8126	383	8164	460	8205	268	8308	26
8127	366	8165	460	8206	268	8315	344
8128	367	8166	244	8207	268	8316	344
8130	367	8167	244	8208	268	8317	344
8131	370	8168	245	8210	268	8318	344
8132	364	8170	245	8211	124	8320	344
8133	269	8171	257	8213	124	8321	344
8134	269	8172	257	8214	124	8322	344
8135	269	8173	373	8215	124	8323	344
8136	269	8174	373	8216	124	8324	345
8137	269	8175	370	8220	322	8325	345

INDEKS LAMP / PROGRESSIVE CODE INDEX / ИНДЕКС СВЕТИЛЬНИКОВ

INDEX	STRONA PAGE СТРАНИЦА	INDEX	STRONA PAGE СТРАНИЦА	INDEX	STRONA PAGE СТРАНИЦА	INDEX	STRONA PAGE СТРАНИЦА
8326	345	8367	392	8443	101	8825	353
8327	345	8368	392	8444	100	8826	335
8330	425	8370	392	8445	100	8827	267
8331	425	8371	393	8446	100	8828	267
8332	133	8372	393	8447	475	8830	451
8333	133	8373	394	8448	138	8831	451
8334	133	8374	394	8490	138	8832	386
8335	133	8375	393	8671	56	8833	386
8336	133	8376	393	8672	56	8834	361
8337	133	8377	476	8673	56	8835	361
8338	133	8378	476	8774	337	8836	361
8340	133	8380	69	8775	337	8837	361
8341	133	8381	69	8776	337	8838	315
8342	133	8382	356	8777	337	8840	315
8343	133	8383	356	8778	337	8841	315
8344	133	8384	360	8780	337	8842	315
8345	132	8385	360	8781	337	8843	109
8346	132	8397	469	8782	337	8845	479
8347	475	8398	469	8794	65	8846	479
8348	475	8404	270	8795	440	8847	228
8350	27	8427	149	8796	25	8850	228
8351	27	8428	149	8797	25	8851	228
8352	27	8430	149	8798	25	8853	228
8353	27	8431	25	8800	28	8854	232
8354	27	8432	25	8802	97	8856	229
8355	27	8433	25	8805	361	8857	229
8356	27	8434	25	8816	310	8858	229
8357	273	8435	25	8817	310	8860	229
8358	272	8436	25	8818	311	8861	229
8362	388	8437	101	8819	311	8862	231
8363	388	8438	101	8820	311	8863	231
8364	388	8440	101	8821	479	8864	230
8365	388	8441	101	8823	351	8865	230
8366	392	8442	101	8824	353	8866	230

INDEKS LAMP / PROGRESSIVE CODE INDEX / ИНДЕКС СВЕТИЛЬНИКОВ

INDEX	STRONA PAGE СТРАНИЦА	INDEX	STRONA PAGE СТРАНИЦА	INDEX	STRONA PAGE СТРАНИЦА	INDEX	STRONA PAGE СТРАНИЦА
8870	230	8934	36	8975	361	9027	176
8873	234	8935	36	8980	122	9028	148
8874	234	8936	334	8981	122	9032	148
8884	52	8937	334	8982	122	9033	148
8885	52	8938	334	8988	395	9042	155
8895	324	8940	334	8990	395	9043	155
8896	324	8942	102	8991	395	9044	155
8897	324	8943	102	8992	395	9045	196
8898	324	8944	102	8993	313	9046	196
8900	324	8945	96	8994	313	9047	196
8901	324	8946	94	8995	342	9054	27
8902	324	8947	94	8996	342	9055	27
8903	324	8948	99	8997	342	9056	70
8908	251	8950	97	8998	342	9057	70
8910	251	8951	93	9000	342	9058	70
8911	32	8952	96	9001	342	9060	70
8912	32	8953	94	9002	342	9061	233
8913	32	8954	92	9003	342	9067	36
8914	28	8955	97	9004	343	9068	36
8915	31	8956	99	9005	343	9070	36
8916	31	8957	92	9006	343	9071	123
8917	31	8958	96	9007	343	9072	123
8918	23	8960	94	9012	358	9073	123
8920	23	8961	99	9013	358	9074	123
8921	23	8962	93	9014	358	9076	172
8922	22	8965	404	9015	358	9077	172
8923	22	8966	404	9018	353	9083	114
8924	22	8967	360	9020	353	9084	112
8925	325	8968	360	9021	223	9090	114
8926	325	8970	361	9022	223	9091	112
8928	325	8971	361	9023	223	9097	420
8930	325	8972	361	9024	223	9100	416
8931	325	8973	361	9025	223	9101	416
8932	325	8974	361	9026	223	9102	463

INDEKS LAMP / PROGRESSIVE CODE INDEX / ИНДЕКС СВЕТИЛЬНИКОВ

INDEX	STRONA PAGE СТРАНИЦА	INDEX	STRONA PAGE СТРАНИЦА	INDEX	STRONA PAGE СТРАНИЦА	INDEX	STRONA PAGE СТРАНИЦА
9103	463	9147	207	9245	350	9338	351
9104	464	9148	207	9246	405	9341	479
9105	464	9150	211	9247	215	9342	474
9106	464	9151	211	9252	441	9343	474
9107	447	9152	69	9260	159	9344	474
9108	447	9153	69	9261	159	9345	474
9110	447	9154	69	9263	158	9346	368
9111	447	9155	69	9264	158	9347	368
9112	446	9158	439	9266	159	9348	368
9113	446	9173	475	9272	79	9350	368
9115	453	9174	368	9273	117	9351	368
9118	419	9175	368	9274	117	9352	368
9120	419	9176	368	9277	116	9353	376
9121	419	9177	476	9278	116	9362	64
9122	427	9178	475	9294	175	9363	64
9123	456	9180	475	9296	174	9364	65
9124	456	9185	436	9297	175	9374	64
9125	441	9186	357	9298	120	9375	150
9126	210	9187	357	9300	122	9377	150
9127	178	9188	357	9301	122	9378	335
9128	178	9190	357	9302	121	9381	199
9130	176	9191	49	9303	122	9382	199
9131	67	9192	49	9304	121	9383	319
9132	67	9197	475	9308	65	9384	318
9135	179	9211	474	9316	319	9385	318
9136	179	9212	474	9317	259	9386	318
9138	185	9213	474	9318	259	9387	318
9140	185	9214	474	9320	259	9388	195
9141	185	9218	121	9321	353	9390	195
9142	209	9237	354	9322	353	9391	190
9143	209	9238	354	9324	350	9392	195
9144	208	9240	319	9325	350	9393	195
9145	208	9241	319	9332	350	9395	312
9146	207	9244	350	9337	351	9396	312

INDEKS LAMP / PROGRESSIVE CODE INDEX / ИНДЕКС СВЕТИЛЬНИКОВ

INDEX	STRONA PAGE СТРАНИЦА	INDEX	STRONA PAGE СТРАНИЦА	INDEX	STRONA PAGE СТРАНИЦА	INDEX	STRONA PAGE СТРАНИЦА
9398	312	9490	267	9593	315	9700	152
9400	312	9491	267	9594	315	9702	261
9403	333	9495	331	9595	315	9703	261
9404	333	9497	331	9596	314	9704	261
9407	333	9500	385	9597	314	9705	261
9408	333	9501	385	9598	314	9706	260
9412	333	9502	371	9600	314	9707	260
9413	333	9503	371	9601	314	9708	260
9416	333	9505	374	9602	314	9710	260
9417	333	9506	375	9603	314	9711	402
9420	441	9507	437	9604	314	9712	402
9421	452	9508	437	9605	104	9713	402
9426	405	9510	455	9606	104	9714	400
9427	351	9513	442	9607	401	9715	401
9448	354	9514	442	9631	183	9716	154
9450	354	9515	457	9665	184	9717	154
9451	354	9516	457	9666	184	9718	154
9452	354	9517	457	9668	184	9721	194
9453	356	9518	457	9670	184	9728	280
9454	356	9551	459	9672	103	9733	176
9455	357	9552	459	9673	103	9734	176
9456	357	9554	465	9674	49	9735	172
9457	357	9555	411	9675	49	9736	119
9458	357	9557	411	9676	49	9737	119
9460	354	9561	410	9677	49	9738	181
9461	354	9562	410	9680	49	9740	180
9462	357	9563	410	9682	105	9741	180
9463	357	9564	443	9683	105	9742	180
9470	331	9565	443	9684	104	9743	186
9472	331	9570	331	9685	104	9744	186
9481	328	9571	331	9687	105	9745	186
9482	328	9574	331	9691	189	9746	188
9485	328	9575	331	9695	190	9747	188
9486	328	9592	315	9696	190	9751	401



MIMAX LIGHTING, S.L.
C/Gran Bretanya, 43
08700 Igualada (Barcelona)
Tel./Fax +34 938 044 621
info@mimaxlighting.com

mimaxlighting.com