

URBAN
L I G H T I N G

N.13

URBAN
LIGHTING

Index

LINEA	12
TECHNICAL DATA	22-32-36-44
PRICE LIST	268
AKI	48
TECHNICAL DATA	71
PRICE LIST	280
OLO	72
TECHNICAL DATA	95
PRICE LIST	282
ANELLO	96
TECHNICAL DATA	107
PRICE LIST	283
LAMOI	108
TECHNICAL DATA	119-125-129
PRICE LIST	287
TESA MINI	130
TECHNICAL DATA	141
PRICE LIST	291
TESA	142
TECHNICAL DATA	149
PRICE LIST	292
LAFRA	150
TECHNICAL DATA	155-165-171-177
PRICE LIST	293
CAOS CONTRACT	178
TECHNICAL DATA	195
PRICE LIST	302
CAOS	196
TECHNICAL DATA	205-211
PRICE LIST	303
AREA	212
TECHNICAL DATA	225
PRICE LIST	305
HONEY BLACK	226
TECHNICAL DATA	245
PRICE LIST	306
BEBA	246
TECHNICAL DATA	265
PRICE LIST	308

INDICE PER TIPOLOGIA

TABLE OF CONTENT BY TYPE / INHALT NACH TYPOLOGIE / ÍNDICE POR TIPO / СПИСОК ПО ТИПОЛОГИИ

**LAMPADE
A SOSPENSIONE**

Suspension lights
Pendelleuchte
Lámparas colgantes
Подвесные светильники

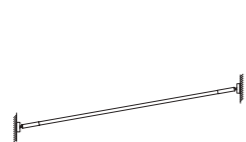

LINEA
1795-1810-1811



p 12 / 23

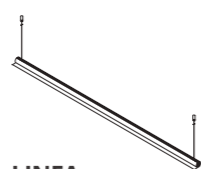

LINEA
1795-1810-1811



p 38 / 47

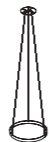

ANELLO
1790-1799
1800-1801



p 96 / 107



LAMOI
1812-1815
1816-1817



p 108 / 119



TESA MINI
1760-1761-1769



p 130 / 141



TESA
1760-1761-1769



p 142 / 149

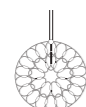

LAFRA
1735-1748-1739



p 150 / 155



LAFRA
1735-1748-1739



p 156 / 165



CAOS CONTRACT
1818-1819



p 178 / 195



CAOS
1818-1819



p 196 / 207



AREA
1737



p 212 / 225



**HONEY
BLACK**
1802



p 226 / 165



BEBA
1730



p 246 / 265

INDICE PER TIPOLOGIA

TABLE OF CONTENT BY TYPE / INHALT NACH TYPOLOGIE / ÍNDICE POR TIPO / СПИСОК ПО ТИПОЛОГИИ

**LAMPADE
A SOFFITTO**

Ceiling lights
Deckenleuchte
Lámparas de techo
Потолочные светильники



LINEA
1795-1810-1811



p 24 / 33



LAMOI
1812-1815
1816-1817



p 120 / 125



TESA MINI
1760-1761-1769



p 136 / 141



LAFRA
1735-1748
1739-1773



p 166 / 171



CAOS
1818-1819



p 208 / 211

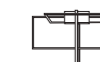

AREA
1737



p 212 / 225

INDICE PER TIPOLOGIA

TABLE OF CONTENT BY TYPE / INHALT NACH TYPOLOGIE / ÍNDICE POR TIPO / СПИСОК ПО ТИПОЛОГИИ

LAMPADE DA PARETE

Wall lights
Wandleuchte
Lámparas de pared
Настенные светильники



LINEA
1795-1810-1811



p 24 / 33



AKI
1796-1797-1798
1803-1804



p 48 / 71

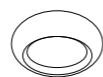

OLO
1776-1785-1791
1792-1793-1794



p 72 / 95



LAFRA
1735-1748
1739-1773



p 172 / 177



LINEA
1795-1810-1811



p 12 / 47



LAMOI
1812-1815
1816-1817



p 126 / 129

LAMPADE DA TERRA

Floor lamps
Stehleuchten
Lámparas de pie
Напольные светильники

INDICE PER CODICE

TABLE OF CONTENTS BY CODE / INHALT NACH ARTIKELNUMMER / ÍNDICE POR REFERENCIA / СПИСОК ПО КОДУ

CODE	ART.	PAG.
1730	BEBA	246
1735	LAFRA	150
1737	AREA	212
1739	LAFRA	150
1748	LAFRA	150
1760	TESA MINI	130
1761	TESA MINI	130
1769	TESA MINI	130
1760	TESA	142
1761	TESA	142
1769	TESA	142
1776	OLO	72
1785	OLO	72
1790	ANELLO	96
1791	OLO	72
1792	OLO	72
1793	OLO	72
1794	OLO	72
1795	LINEA	12
1796	AKI	48
1797	AKI	48
1798	AKI	48
1799	ANELLO	96
1800	ANELLO	96
1801	ANELLO	96
1802	HONEY BLACK EDITION	226
1803	AKI	48
1804	AKI	48
1810	LINEA	12
1811	LINEA	12
1812	LAMOI GOLD EDITION	108
1815	LAMOI	108
1816	LAMOI	108
1817	LAMOI	108
1818	CAOS GOLD EDITION	196
1819	CAOS CONTRACT BLACK EDITION	196

OMOLOGAZIONI E SIMBOLI

TYPE APPROVALS & SYMBOLS / ZULASSUNGEN & SYMBOLE / HOMOLOGACIONES Y SÍMBOLOS / ОМОЛОГАЦИИ И УСЛОВНЫЕ ОБОЗНАЧЕНИЯ



APPARATO CONFORME ALLE DIRETTIVE DELLA COMUNITÀ EUROPEA

The appliance conforms to European Community Directives.

Gerät ist konform mit den Richtlinien der Europäischen Gemeinschaft.

Aparato conforme con las Directivas Comunitarias Europeas.

Прибор соответствует требованиям Директив Европейского Сообщества.



APPARATO DOTATO DI ISOLAMENTO PRINCIPALE

The appliance is fitted with basic insulation.

Gerät ist mit der Basisisolierung ausgestattet.

Aparato dotado de aislamiento básico.

Прибор снабжен главной изоляцией.



APPARATO IDONEO PER ESSERE INSTALLATO SU SUPERFICI INFIAMMABILI

Suited for assembly on flammable surfaces.

Geeignet für die montage auf entflammaren oberflächen.

Adecuado para montaje en superficies inflamables.

Прибор годен для установки на пожароопасных поверхностях.



APPARATO DOTATO DI DOPPIO ISOLAMENTO

The appliance is fitted with double insulation.

Gerät ist mit zwei isolierungen ausgestattet.

Aparato dotado de doble aislamiento.

Прибор снабжен двойной изоляцией.



BASSISSIMA TENSIONE

Very low voltage.

Niederwolt.

Muy baja tensión.

низковольтные.



APPARECCHIO DOTATO DI MODULO LED

Unit equipped with LED module.

Gerät mit LED Modul.

Aparato con módulo LED.

Прибор снабжен светодиодным модулем.



GRADI KELVIN UNITÀ DI MISURA DELLA TEMPERATURA DI COLORE

KELVIN DEGREES - Unit of temperature measurement.

GRAD KELVIN - Maßeinheit der Farbtemperatur.

GRADOS KELVIN - Unidad de medida de la temperatura de color.

ГРАДУСЫ КЕЛЬВИНА GRADI KELVIN
Единица измерения цветовой температуры.

2700°K 3000°K 3500°K 4000°K 4500°K

CALDO - WARM
WARM - CALIENTE
ТЕПЛЫЙ СВЕТ

FREDDO - COLD
KALT - FRÍO
ХОЛОДНЫЙ СВЕТ

Lumen

UNITÀ DI MISURA DEL FLUSSO LUMINOSO

Unit of measurement of luminous flux.

Maßeinheit des Lichtstroms.

Unidad de medida del flujo luminoso.

Единица измерения светового потока.

mA

INTENSITÀ DI CORRENTE ELETTRICA

The appliance is fitted with double insulation. Intensità des elektrischen Stroms.

Intensidad de corriente eléctrica.

Сила электрического тока.

DESIGNERS



Andrea Barra



_blank design studio



Extravergine



Gerardo Mari



Marco Spatti



Studio O.i.l.

LINEA

design _blank design studio + Gerardo Mari

REGISTERED TRADEMARK_MODELLO REGISTRATO
GESCH TZTES MUSTER_MODELO REGISTRADO
ЗАРЕГИСТРИРОВАННАЯ МОДЕЛЬ

LINEA COLLECTION

Linea is a system made of flexible LED linear lighting elements. Made with a harmonic steel core, Linea can be stretched between two walls, not necessarily parallel, thanks to the tensile joints at the ends of the system. It can also be ceiling-mounted and turned into free geometric shapes thanks to the brackets that manage the core of the lamp. A silicone cover allows a consistent diffusion of the light generated by two opposing LED strips with a combined power up to 1,900 lumens/meter.

WINNER



LINEA

Linea è un sistema di elementi illuminanti lineari flessibili a led. Realizzati con un'anima in acciaio armonico, Linea può essere tesa tra due pareti, non necessariamente parallele, grazie agli snodi tensori alle estremità del sistema, ma può anche essere installata a soffitto e composta in forme geometriche libere grazie ai supporti che vanno a guidare l'anima interna della lampada. Una copertura silconica permette una diffusione uniforme della luce generata da due strip led contrapposte con potenza combinata fino a 1900 lumen/metro.

LINEA

Linea ist ein System aus flexiblen, linearen LED-Beleuchtungselementen. Linea besteht aus einem harmonischen Stahlkern und kann dank der an den Enden des Systems befindlichen Zugverbindungen zwischen zwei Wänden gespannt werden, was nicht unbedingt parallel geschehen muss, kann aber auch an der Decke installiert und nach Belieben geometrisch angeordnet werden, und zwar dank der Halterungen, die den inneren Kern der Lampe führen. Eine Silikonabdeckung ermöglicht eine gleichmäßige Streuung des Lichts, das von zwei gegenüberliegenden LED-Streifen mit einer kombinierten Leistung von bis zu 1900 Lumen/Meter erzeugt wird.

LINEA

Linea es un sistema de elementos lineales flexibles de iluminación con led. Fabricados con un núcleo de acero armónico, Linea se puede tender entre dos paredes, no necesariamente paralelas, gracias a las articulaciones tensoras en los extremos del sistema, pero también se puede instalar en el techo y permite realizar formas geométricas libres gracias a los soportes que guían el núcleo interno de la lámpara. Una cobertura de silicona permite difundir de manera uniforme la luz generada por dos tiras de led contrapuestas que ofrecen una potencia combinada de hasta 1900 lúmenes/metro.

LINEA

Linea - это система гибких светодиодных линейных световых элементов. Реализованная с гармоническим стальным сердечником, Linea может быть натянута между двумя стенами, не обязательно параллельно, благодаря шарнирным растяжкам на концах системы, а также может быть установлена на потолке и составлена в свободной геометрической форме, благодаря системе опор, которые направляют внутренний стержень лампы. Siliconовый кожух позволяет равномерно рассеивать свет, генерируемый двумя противоположными светодиодными полосами с суммарной мощностью до 1900 люмен/метр.





LINEA WALL-WALL





LINEA WALL-WALL



LINEA

Wall-wall assembly

Installazione parete/parete / Wand/Wand Installation / Instalación pared/pared / Установка от стены до стены

Remote driver options

Opzioni con driver remoto
Optionen mit entfernt liegendem Driver
Opciones con driver remoto
Вариант с удаленным устройством управления

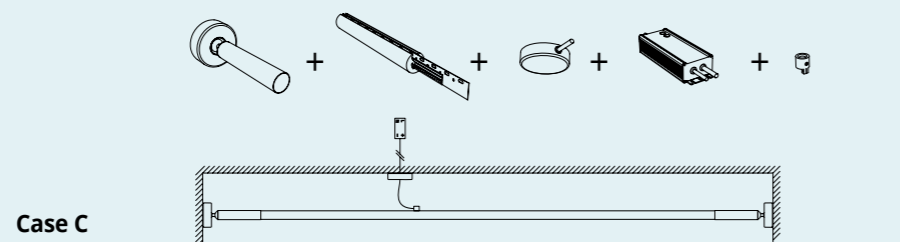
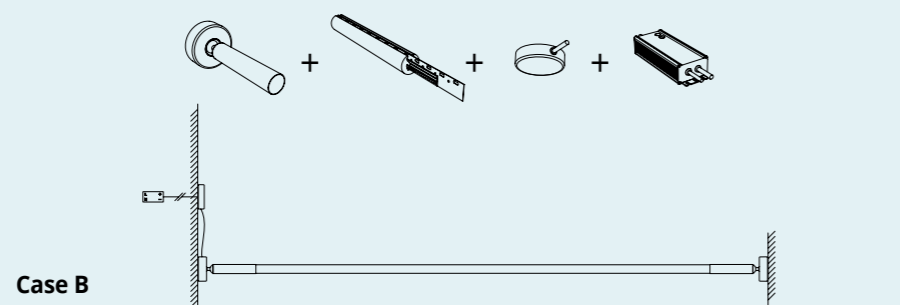
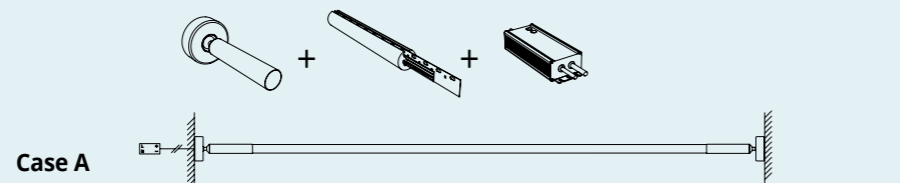

On-board driver options

Opzioni con driver a bordo
Optionen mit an der Einheit befindlichem Driver
Opciones con driver a bordo
Вариант со встроенным устройством управления

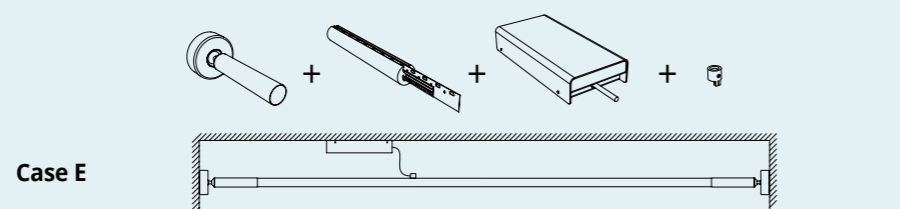
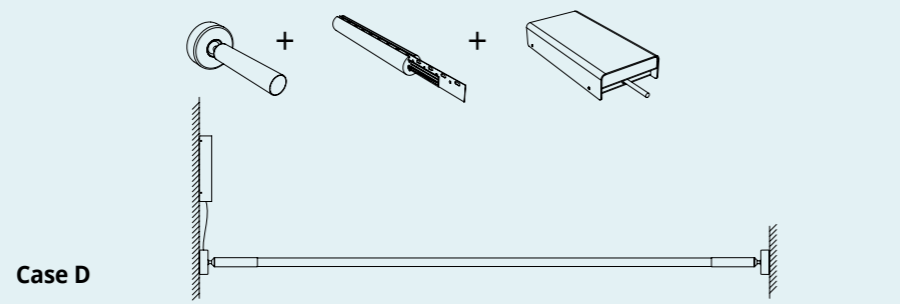

WALL-WALL / FLOOR-CEILING DIMENSIONS

Dimensione parete-parete / terra-soffitto
Abmessungen wand-wand / boden-decke
Medida pared-pared / suelo-techo
Версия от стены до стены / от пола до потолка

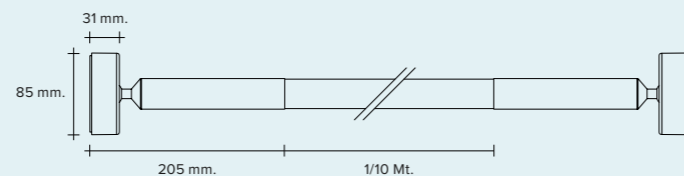

LINEA

System

LED linear lighting system
Sistema di illuminazione lineare a Led
Lineares LED-Beleuchtungssystem
El sistema de iluminación lineal de led
Линейная светодиодная осветительная система

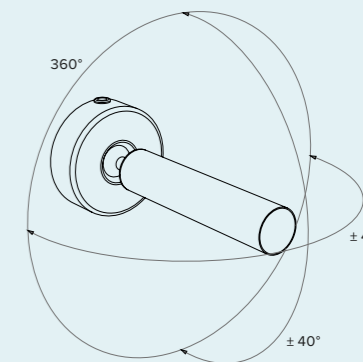

FINISHES / FINITURE / FARBE / ACABADOS / ОТДЕЛКИ

FRAME - CANOPIES - DRIVER BOX

Montatura - Rosoni - Driver Box / Gestell - Baldachin - Driver Box / Estructura - Florones - Driver Box
Отделка - Основания светильника - светодиодные драйверы

- Brushed aluminium / Alluminio spazzolato / Gebürstetes Aluminium / Aluminio cepillado / Крацованный алюминий
- Black / Nero / Schwarz / Negro / Чёрный цвет
- Sand / Sabbia / Sandfarben / Arena / Песочный цвет

DIFFUSER

Diffusore / Diffusorabdeckung / Difusor / Рассеиватель

- White opaline silicone / Silicone bianco opalino / Weiß opalfarben silikon / Silicona blanca opalin / Белый молочный силикон

LIGHT SOURCE / SORGENTE / LICHTQUELLE / FUENTE LUMINOSA / ИСТОЧНИК СВЕТА

1 m.	LED 20W	48V	2700°K / 1700 Lumen	CRI 90	6 m.	LED 120W	48V	2700°K / 10200 Lumen	CRI 90
			3000°K / 1900 Lumen	CRI 90				3000°K / 11400 Lumen	CRI 90
2 m.	LED 40W	48V	2700°K / 3400 Lumen	CRI 90	7 m.	LED 140W	48V	2700°K / 11900 Lumen	CRI 90
			3000°K / 3800 Lumen	CRI 90				3000°K / 13300 Lumen	CRI 90
3 m.	LED 60W	48V	2700°K / 5100 Lumen	CRI 90	8 m.	LED 160W	48V	2700°K / 13600 Lumen	CRI 90
			3000°K / 5700 Lumen	CRI 90				3000°K / 15200 Lumen	CRI 90
4 m.	LED 80W	48V	2700°K / 6800 Lumen	CRI 90	9 m.	LED 180W	48V	2700°K / 15300 Lumen	CRI 90
			3000°K / 7600 Lumen	CRI 90				3000°K / 17100 Lumen	CRI 90
5 m.	LED 100W	48V	2700°K / 8500 Lumen	CRI 90	10 m.	LED 200W	48V	2700°K / 17000 Lumen	CRI 90
			3000°K / 9500 Lumen	CRI 90				3000°K / 19000 Lumen	CRI 90

DRIVER BOX L

xxxx.B3
xxxx.B5
xxxx.B6

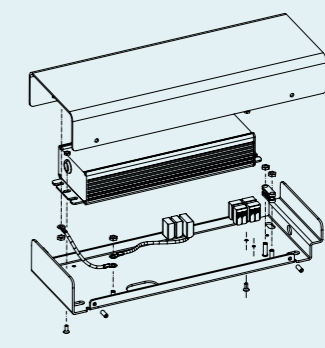
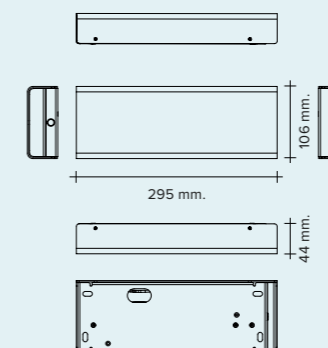

DRIVER BOX S

xxxx.B1
xxxx.B2
xxxx.B4

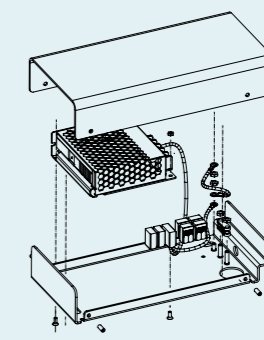
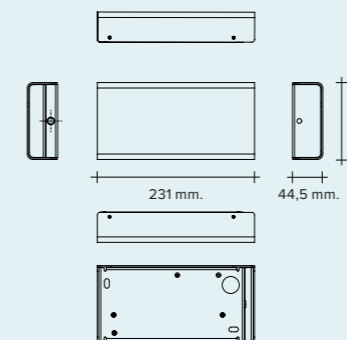

CANOPIE

xxxx.M4



* Power cable: 1,2 m.
Cavo di alimentazione: 1,2 m. / Stromversorgungskabel: 1,2 m. / Cable de alimentación: 1,2 m. / Шнур питания: 1,2 m.

See codes and prices from page to page / Vedi codici e prezzi da pag a pag. / Artikelnummern und Preise siehe Seite bis Seite
Véanse códigos y precios desde pág. hasta pág. / См. коды и цены от страницы до страницы



LINEA

SURFACE MOUNTING





LINEA SURFACE MOUNTING

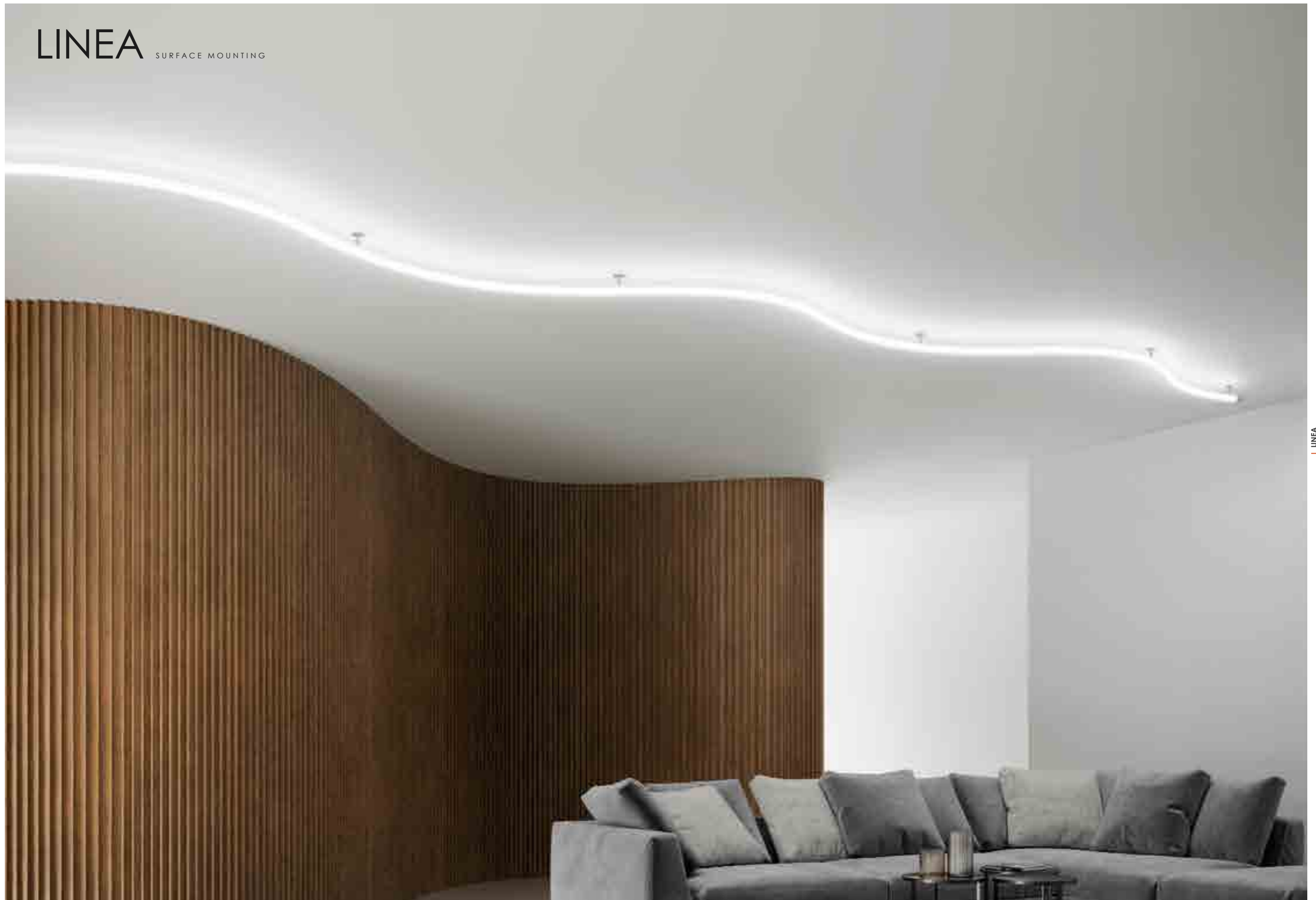

LINEA

SURFACE MOUNTING



Surface mounting

Installazione superficiale / Aufputz-Installation / Instalación en superficie / Установка на поверхность стены или потолка

Remote driver options

Opzioni con driver remoto
Optionen mit entfernt liegendem Driver
Opciones con driver remoto
Вариант с удаленным устройством управления

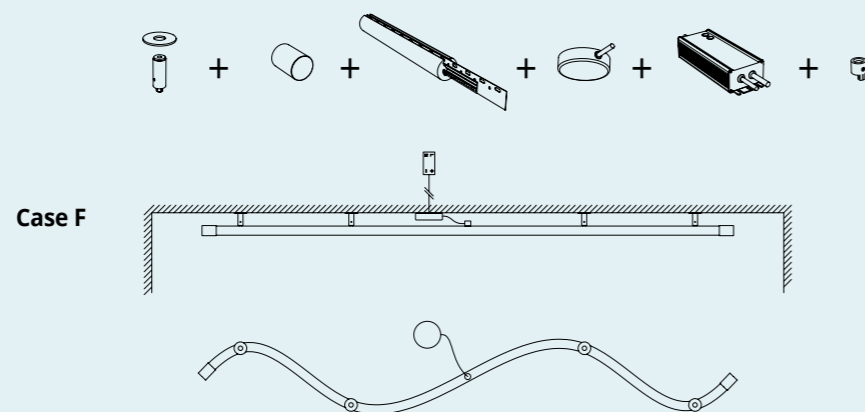

On-board driver options

Opzioni con driver a bordo
Optionen mit an der Einheit befindlichem Driver
Opciones con driver a bordo
Вариант со встроенным устройством управления

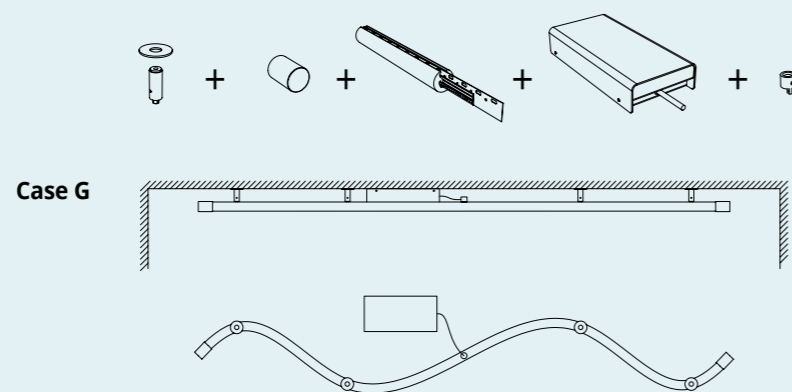

WALL / CEILING DIMENSIONS

Dimensione parete / soffitto
Abmessungen wand/decke
Medidas pared / techo
Версия стена / потолок

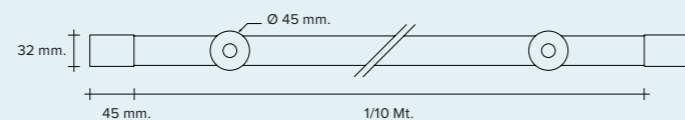

* Power cable: 1,5 m.

Cavo di alimentazione: 1,5 m. / Stromversorgungskabel: 1,5 m. / Cable de alimentación: 1,5 m. / Шнур питания: 1,5 m.

IF YOU NEED THE FOLLOWING TYPES OF INSTALLATIONS PLEASE SHARE WITH US SIZE A WHEN ORDERING

Nei seguenti casi di installazione comunicare la misura A al momento dell'ordine / In den folgenden Installationssituationen bitte bei der Bestellung das Maß A mitteilen / En los siguientes casos de instalación al hacer el pedido es necesario comunicar la medida A / В следующих случаях при размещении заказа следует сообщить размер A

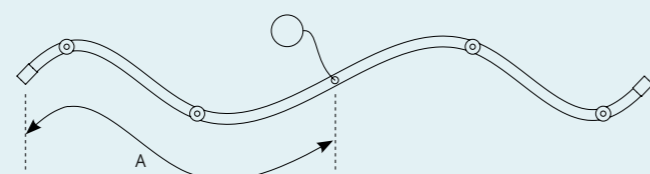

LINEA

System

LED linear lighting system
Sistema di illuminazione lineare a Led
Lineares LED-Beleuchtungssystem
El sistema de iluminación lineal de led
Линейная светодиодная осветительная система



FINISHES / FINITURE / FARBE / ACABADOS / ОТДЕЛКИ

FRAME - CANOPIES - DRIVER BOX

Montatura - Rosoni - Driver Box / Gestell - Baldachin - Driver Box / Estructura - Florones - Driver Box
Отделка - Основания светильника - светодиодные драйверы

- Brushed aluminium / Alluminio spazzolato / Gebürstetes Aluminium / Aluminio cepillado / Крацованный алюминий
- Black / Nero / Schwarz / Negro / Чёрный цвет
- Sand / Sabbia / Sandfarben / Arena / Песочный цвет

DIFFUSER

Diffusore / Diffusorabdeckung / Difusor / Рассеиватель

- White opaline silicone / Silicone bianco opalino / Weiß opalfarben silikon / Silicona blanca opalin / Белый молочный силикон

LIGHT SOURCE / SORGENTE / LICHTQUELLE / FUENTE LUMINOSA / ИСТОЧНИК СВЕТА

1 m.	LED 20W	48V	2700°K / 1700 Lumen	CRI 90	6 m.	LED 120W	48V	2700°K / 10200 Lumen	CRI 90
			3000°K / 1900 Lumen	CRI 90				3000°K / 11400 Lumen	CRI 90
2 m.	LED 40W	48V	2700°K / 3400 Lumen	CRI 90	7 m.	LED 140W	48V	2700°K / 11900 Lumen	CRI 90
			3000°K / 3800 Lumen	CRI 90				3000°K / 13300 Lumen	CRI 90
3 m.	LED 60W	48V	2700°K / 5100 Lumen	CRI 90	8 m.	LED 160W	48V	2700°K / 13600 Lumen	CRI 90
			3000°K / 5700 Lumen	CRI 90				3000°K / 15200 Lumen	CRI 90
4 m.	LED 80W	48V	2700°K / 6800 Lumen	CRI 90	9 m.	LED 180W	48V	2700°K / 15300 Lumen	CRI 90
			3000°K / 7600 Lumen	CRI 90				3000°K / 17100 Lumen	CRI 90
5 m.	LED 100W	48V	2700°K / 8500 Lumen	CRI 90	10 m.	LED 200W	48V	2700°K / 17000 Lumen	CRI 90
			3000°K / 9500 Lumen	CRI 90				3000°K / 19000 Lumen	CRI 90

DRIVER BOX L

xxxx.B3
xxxx.B5
xxxx.B6

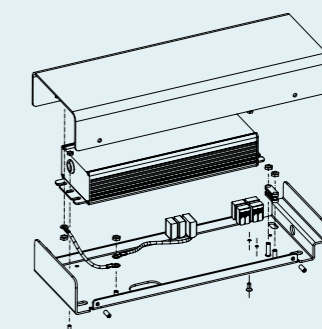
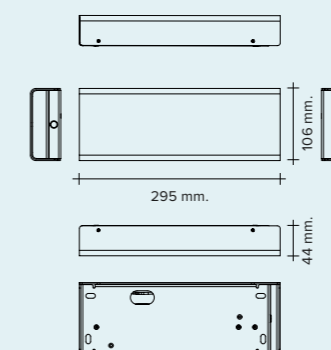

DRIVER BOX S

xxxx.B1
xxxx.B2
xxxx.B4

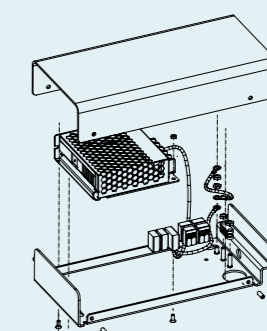
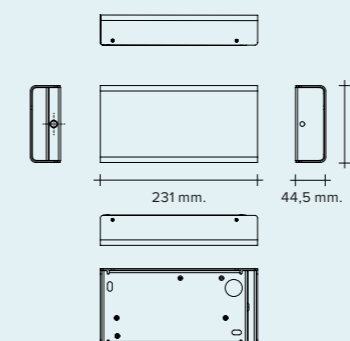

CANOPIE

xxxx.M4



See codes and prices from page to page / Vedi codici e prezzi da pag a pag. / Artikelnummern und Preise siehe Seite bis Seite
Véanse códigos y precios desde pág. hasta pág. / См. коды и цены от страницы до страницы

272 - 273 - 274 - 275

LINEA

VERTICAL SUSPENSION



LINEA

Suspended installation

Installazione a sospensione / Installation als Hängeleuchte / Instalación de suspensión / Подвесная установка

Vertical assembly

Montaggio verticale
Vertikale Montage
Montaje vertical
Вертикальная установка

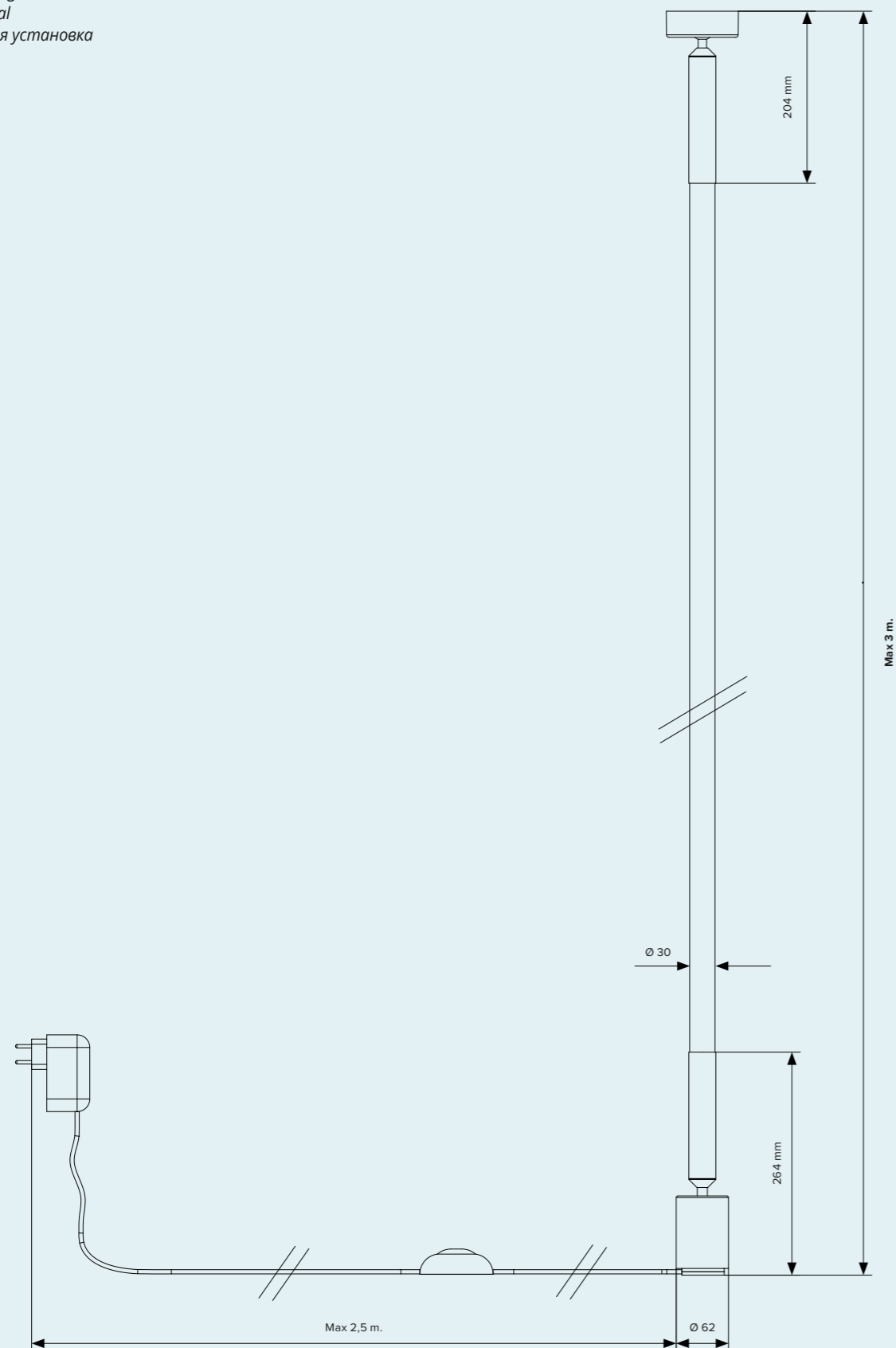

LINEA

System

LED linear lighting system
Sistema di illuminazione lineare a Led
Lineares LED-Beleuchtungssystem
El sistema de iluminación lineal de led
Линейная светодиодная осветительная система



FINISHES / FINITURE / FARBE / ACABADOS / ОТДЕЛКИ

FRAME

Montatura / Gestell / Estructura / Отделка

- Brushed aluminium / Alluminio spazzolato / Gebürstetes Aluminium / Aluminio cepillado / Крацованный алюминий
- Black / Nero / Schwarz / Negro / Чёрный цвет
- Sand / Sabbia / Sandfarben / Arena / Песочный цвет

DIFFUSER

Diffusore / Diffusorabdeckung / Difusor / Рассеиватель

- White opaline silicone / Silicone bianco opalino
Weiß opalfarben silikon / Silicona blanca opalina / Белый молочный силикон

LIGHT SOURCE / SORGENTE / LICHTQUELLE / FUENTE LUMINOSA / ИСТОЧНИК СВЕТА

3 m.	LED 60W	48V *	2700°K / 5100 Lumen	CRI 90
			3000°K / 5700 Lumen	CRI 90

* Dimmable - Foot-dimmable. Plug connector

Dimmerabile. Dimmer a piede. Alimentatore a spina
Dimmbar - Fußdimmer. Steckernetzteil
Atenuable - Regulador de intensidad de pie. Fuente de alimentación con enchufe
С регулируемой яркостью - Педальный диммер. Штепсельный блок питания.



LINEA

HORIZONTAL SUSPENSION





Suspended installation

Installazione a sospensione / Installation als Hängeleuchte / Instalación de suspensión / Подвесная установка

Horizontal assembly

Montaggio orizzontale
Horizontale Montage
Montaje horizontal
Горизонтальный монтаж

S1

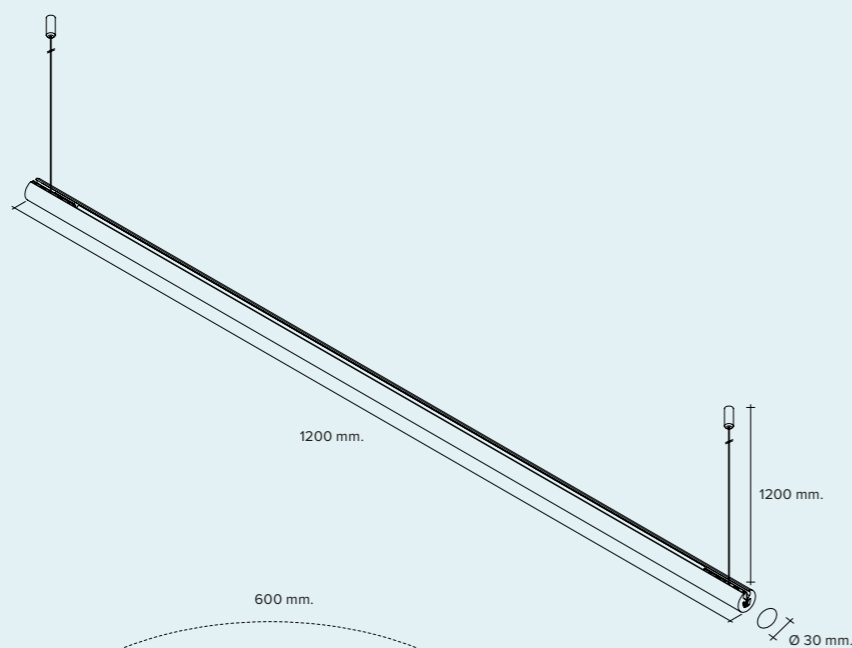

S2

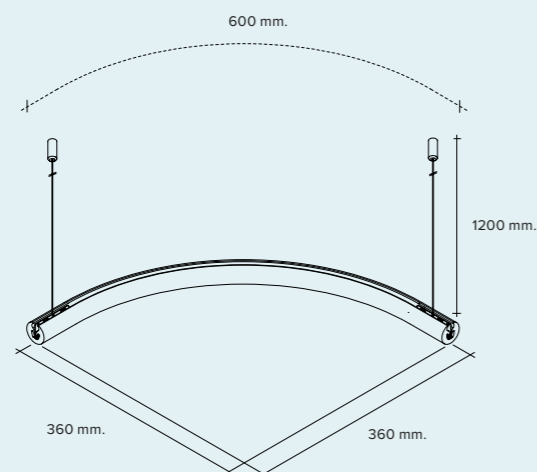

S3

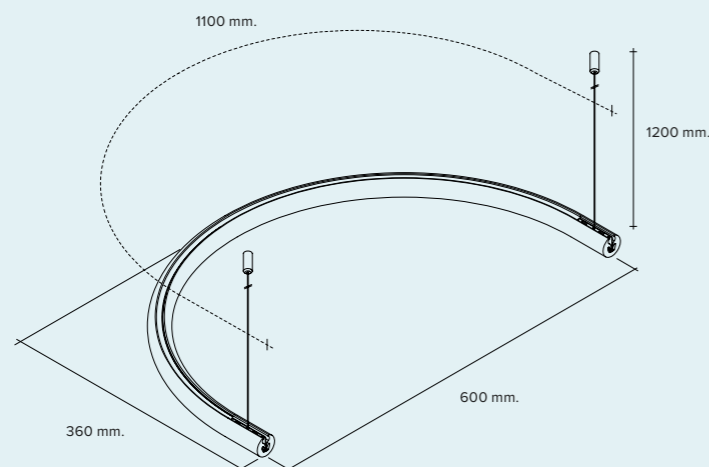

* Power cable: 2 m. Steel core elements cannot be cut to measure

Cavo di alimentazione: 2 m. Elementi con anima in acciaio non sezionabili a misura

Stromversorgungskabel: 2 m. Elemente mit Stahlkern, die nicht auf Maß geschnitten werden können

Cable de alimentación: 2 m. Elementos con núcleo de acero, no pueden cortarse a medida

Шнур питания: 2 м. Элементы со стальным сердечником, резка по индивидуальному размеру невозможна.

LINEA

System

LED linear lighting system

Sistema di illuminazione lineare a Led

Lineares LED-Beleuchtungssystem

El sistema de iluminación lineal de led

Линейная светодиодная осветительная система



FINISHES / FINITURE / FARBE / ACABADOS / ОТДЕЛКИ

FRAME - CANOPIES - DRIVER BOX

Montatura - Rosoni - Driver Box / Gestell - Baldachin - Driver Box / Estructura - Florones - Driver Box

Отделка - Основания светильника - светодиодные драйверы

● Brushed aluminium / Alluminio spazzolato / Gebürstetes Aluminium / Aluminio cepillado / Крацованный алюминий

● Black / Nero / Schwarz / Negro / Чёрный цвет

● Sand / Sabbia / Sandfarben / Arena / Песочный цвет

DIFFUSER

Diffusore / Diffusorabdeckung / Difusor / Рассеиватель

● White opaline silicone / Silicone bianco opalino / Weiß opalfarben silikon / Silicona blanca opalin / Белый молочный силикон

LIGHT SOURCE / SORGENTE / LICHTQUELLE / FUENTE LUMINOSA / ИСТОЧНИК СВЕТА

Model	LED Power	Voltage	Color Temperature	Lumen	CRI
S1	LED 24W	48V	2700°K	2040 Lumen	CRI 90
			3000°K	2280 Lumen	CRI 90
S2	LED 12W	48V	2700°K	1020 Lumen	CRI 90
			3000°K	1140 Lumen	CRI 90
S3	LED 22W	48V	2700°K	1870 Lumen	CRI 90
			3000°K	2090 Lumen	CRI 90

DRIVER BOX L

xxxx.B3
xxxx.B5
xxxx.B6

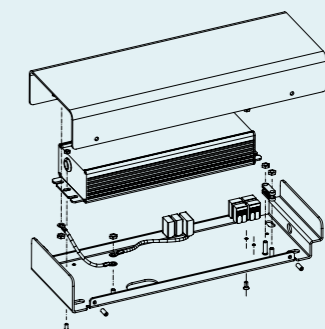
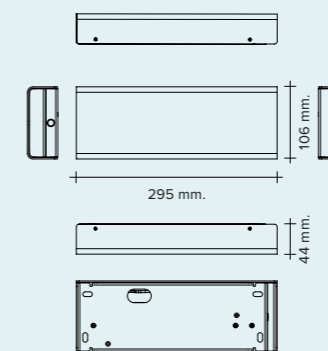

DRIVER BOX S

xxxx.B1
xxxx.B2
xxxx.B4

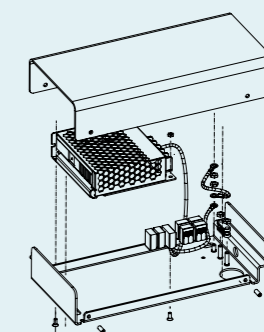
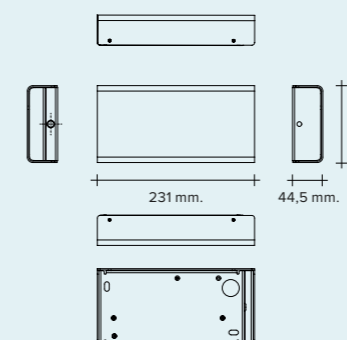

CANOPIE

xxxx.M4



Ø 85

See codes and prices from page to page / Vedi codici e prezzi da pag. a pag. / Artikelnummern und Preise siehe Seite bis Seite
Véanse códigos y precios desde pág. hasta pág. / См. коды и цены от страницы до страницы

277 - 278 - 279

Settings and components

Configurazione e componenti / Konfigurationen und Komponenten / Configuraciones y componentes / Компоновка и детали

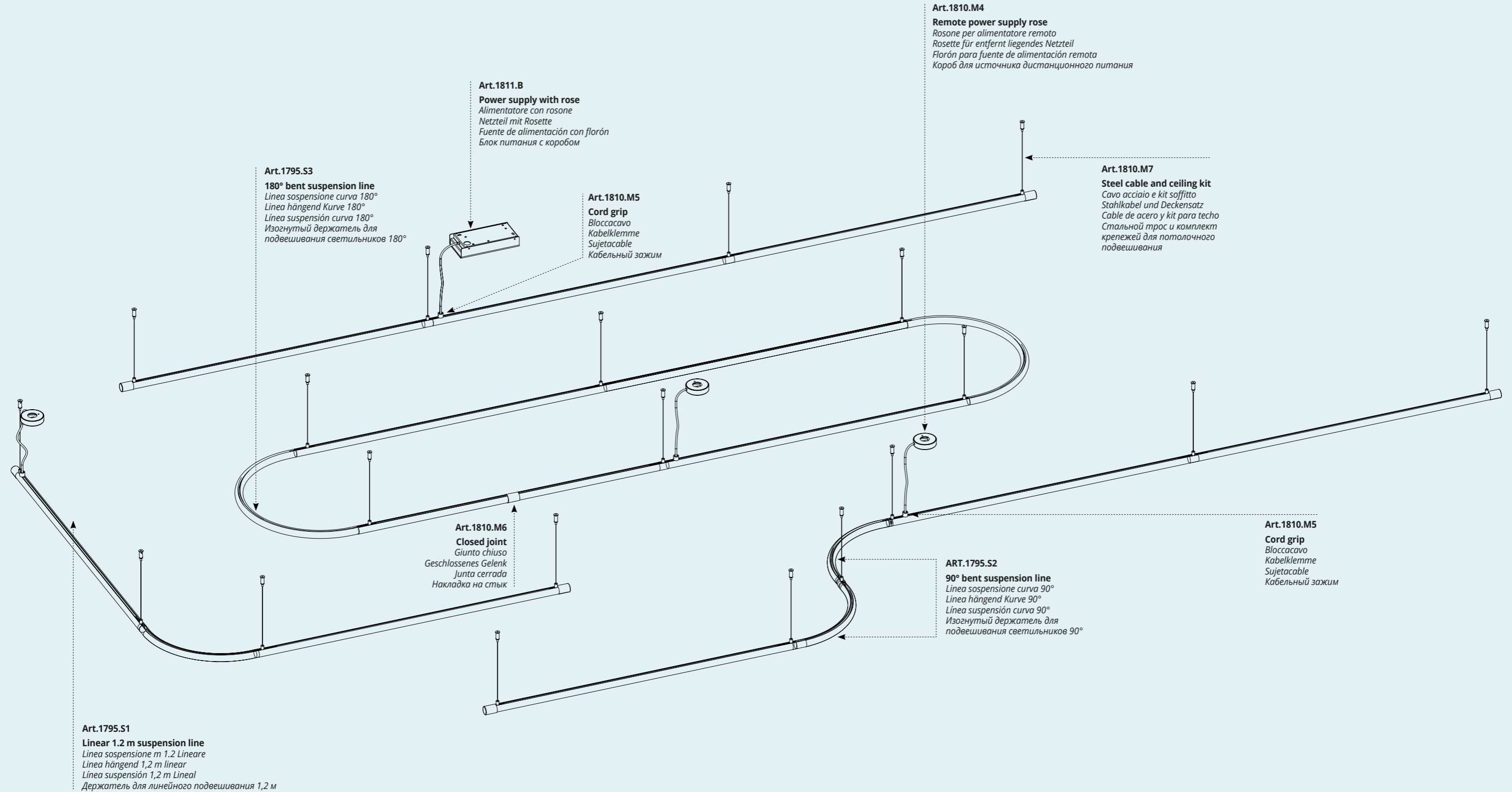

AKI

design Extravergine

AKI

Wall lamp for interiors, with body made of fully recyclable die-cast aluminum. The lamp includes a built-in cooler with an LED that guarantees performance, quality of light and long life. The light is diffused, developing both upwards and downwards.

AKI

Lampada da parete per interni, con corpo realizzato in alluminio pressofuso interamente riciclabile. È una lampada con dissipatore integrato sul quale è alloggiato un LED che garantisce prestazioni, qualità della luce e lunga durata. La luce è diffusa, sviluppandosi sia verso l'alto che verso il basso.

AKI

Wandleuchte für Innenräume, mit Korpus aus Aluminiumdruckguss, vollständig recycelbar. Es handelt sich um eine Leuchte mit integriertem Kühlkörper, auf dem eine LED angebracht ist, die Leistung, Lichtqualität und lange Lebensdauer garantiert. Das diffuse Licht strahlt sowohl nach oben als auch nach unten.

AKI

Lámpara de pared para interiores, con cuerpo de aluminio fundido a presión totalmente reciclable. Se trata de una lámpara con un dissipador de calor integrado en el que se aloja un LED que garantiza rendimiento, calidad de la luz y larga duración. La luz es difusa y va tanto hacia arriba como hacia abajo.

AKI

Настенный светильник для внутреннего освещения с корпусом из алюминия, отлитого под давлением. Материал пригоден для вторичного использования. Это светильник со встроенным рассеивателем, на котором размещен светодиод, обеспечивающий хорошие рабочие характеристики, качество света и долгий срок службы. Свет рассеивается как вверх, так и вниз.



AKI APPLIQUE

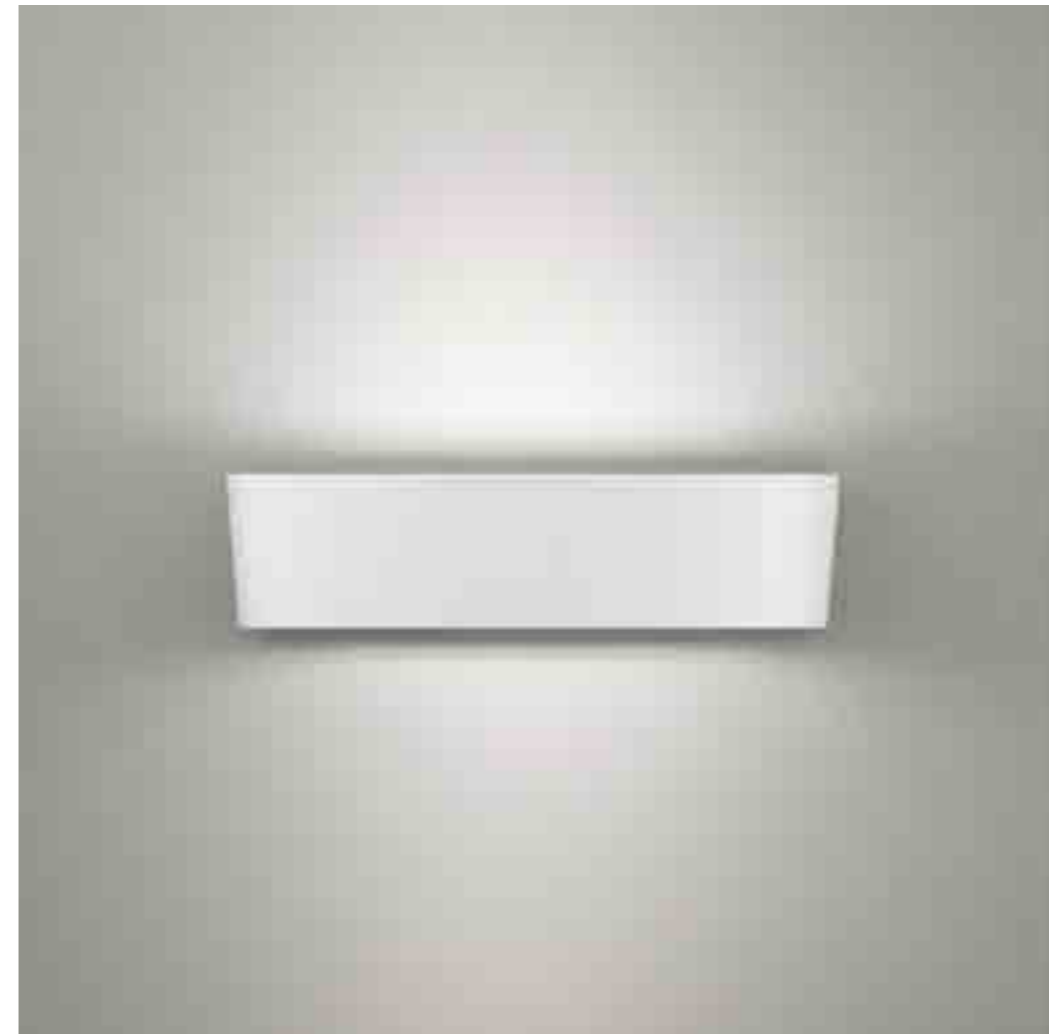



AKI APPLIQUE





AKI APPLIQUE





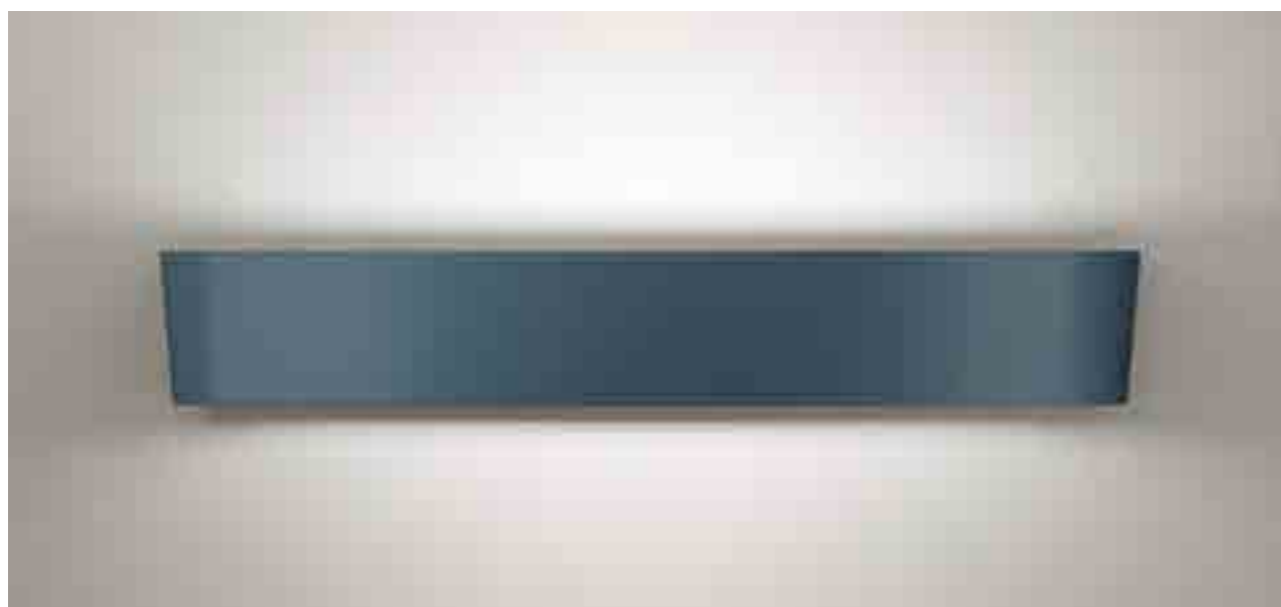



AKI APPLIQUE



AKI APPLIQUE

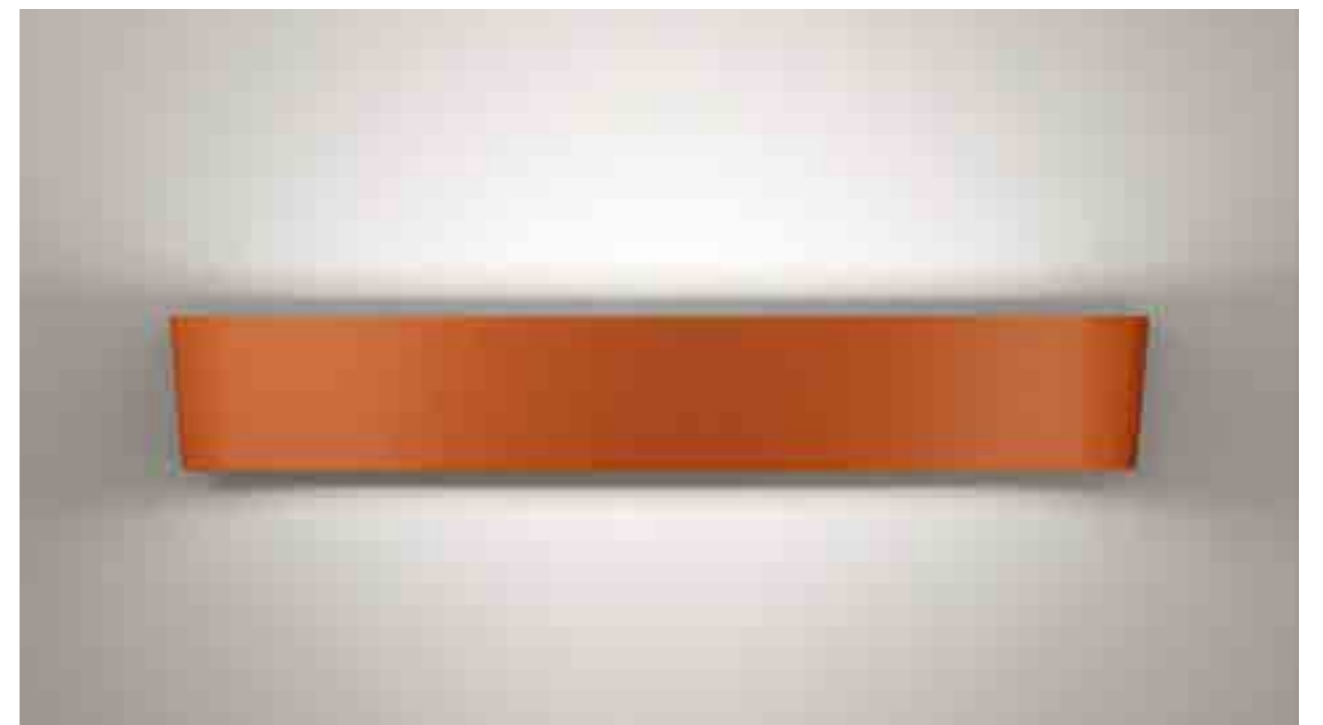

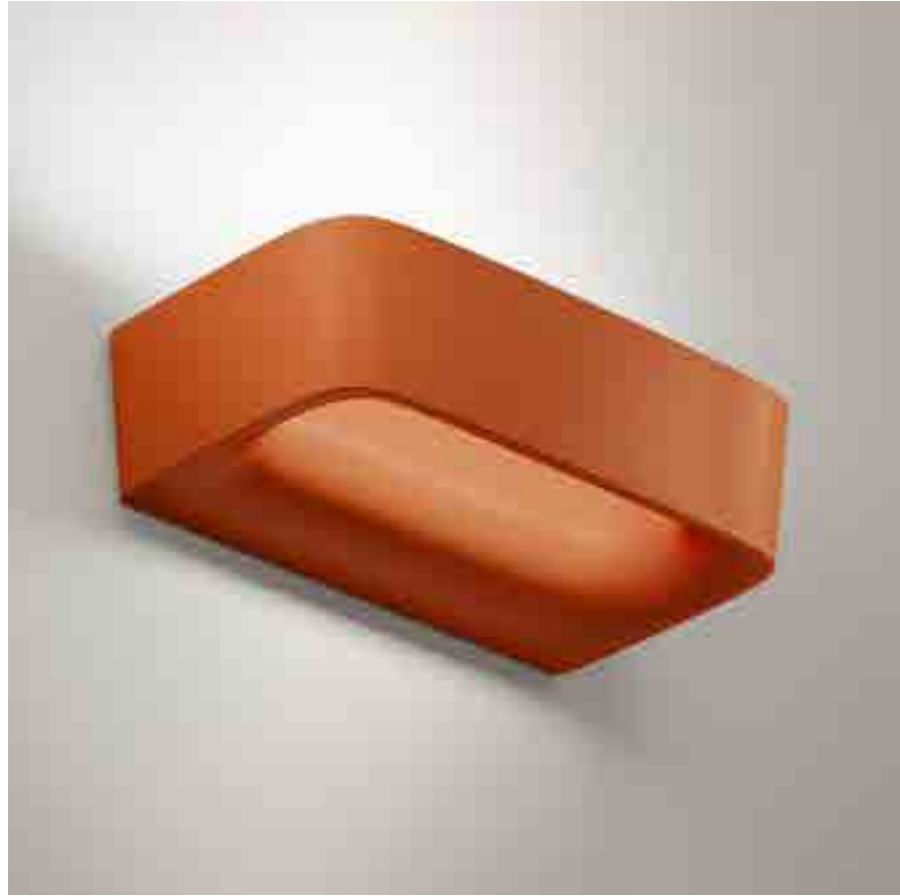

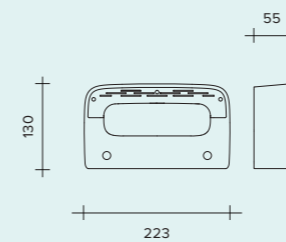

LED 11W
 2700°K / 1567 lumen
 3000°K / 1650 lumen
 4000°K / 1733 lumen
 CRI 90

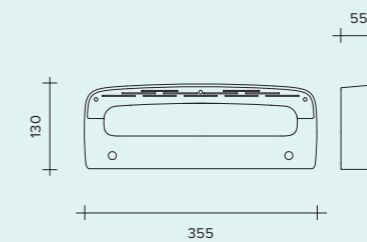

LED 22W
 2700°K / 3054 lumen
 3000°K / 3215 lumen
 4000°K / 3375 lumen
 CRI 90

AKI Applique

Lampada da parete
 Wandleuchte
 Lámpara de pared
 Настенная лампа



FINISHES / FINITURE / FARBE / ACABADOS / ОТДЕЛКИ

- White / Bianco / Weiß / Blanco / Белый цвет
- Sand / Sabbia / Sandfarben / Arena / Песочный цвет
- Brown / Moro / Braun / Marrón oscuro / Тёмно-коричневый цвет
- Petrol Blue / Blu ottanio / Oktanblau / Azul verdoso / Сине-зеленый
- Brick brown / Mattone / Ziegelstein / Ladrillo / Кирпичный цвет

OLO

The Olo wall light features clean geometric shapes and well defined lines.

Designed to enhance environments, whether on or off, it is not intrusive and adapts easily to any interior space.

The rapid section changes and play of solids and voids give it a lightweight look, allowing light to pass through and wash the wall in a uniform manner.

The solid aluminium body, designed as a single piece, is die cast and available in powder-coated matt black or white finish or in a brushed finish in gold, copper, bronze or black nickel colours.

WINNER



OLO

Olo è una lampada da parete dalle geometrie pulite e dalle linee definite.

Disegnata per caratterizzare gli ambienti, tanto da accesa quanto da spenta, non risulta mai intrusiva e si adatta facilmente a qualsiasi interno.

I rapidi cambi di sezione ed i giochi di pieni e vuoti contribuiscono a rendere leggera la sua estetica lasciando passare la luce e permettendole di lavare uniformemente la parete.

Il solido corpo in alluminio, studiato in un unico pezzo, è realizzato in pressofusione ed è disponibile verniciato in bianco o nero opaco, oppure in finitura spazzolata nei colori: oro, rame, bronzo o nichel nero.

OLO

Olo ist eine Wandleuchte von sauberer Geometrie und mit definierten Linien.

Ihr Design wurde so gewählt, dass sie in ihrem Ambiente immer eine gute Figur macht, egal ob sie nun an oder aus ist; sie wirkt nie aufdringlich und passt sich jeder Umgebung an.

Die raschen Abschnittwechsel und die Spiele aus Voll und Leer tragen dazu bei, dass sie leicht erscheint; das Licht strahlt hindurch und erhellt gleichmäßig die Wand. Der solide Korpus wird in einem Stück aus druckgegossenem Aluminium angefertigt und ist in mattweiß oder mattschwarz lackiert erhältlich oder mit einem gebürsteten Oberflächenfinish in den Farben: Gold, Kupfer, Bronze oder Nickel schwarz.

OLO

Olo es un aplique de pared con unas geometrías resueltas y líneas definidas.

Diseñada para caracterizar los ambientes, tanto cuando está encendida como cuando está apagada, nunca es intrusiva y se adapta fácilmente a cualquier interior.

Los rápidos cambios de sección y las combinaciones de llenos y vacíos contribuyen a hacer ligero su aspecto, dejando pasar la luz y permitiéndole iluminar uniformemente la pared. El cuerpo sólido de aluminio, estudiado en una sola pieza, lo realizamos mediante vaciado a presión y está pintado en los colores blanco o negro mate o bien con acabado cepillado en los colores: oro, cobre, bronce o níquel negro.

OLO

Olo – это настенный светильник чистой геометрической формы и с четко выраженным дизайном.

Спроектированный, чтобы охарактеризовать любые интерьеры, как в включённом, так и в выключенном режиме, он никогда не является неуместным и легко подходит к любому интерьеру.

Быстрое изменение ширины сечения и игра полных и пустых объемов способствуют созданию чувства лёгкости его внешнего вида, пропускают свет и позволяют равномерно осветить стену 'омывающим' светом. Прочный монолитный алюминиевый корпус изготовлен путём литья под давлением и может быть окрашенным в белый или чёрный матовый цвет или с крацованной отделкой в цветах: золото, медь, бронза или чёрный никель.

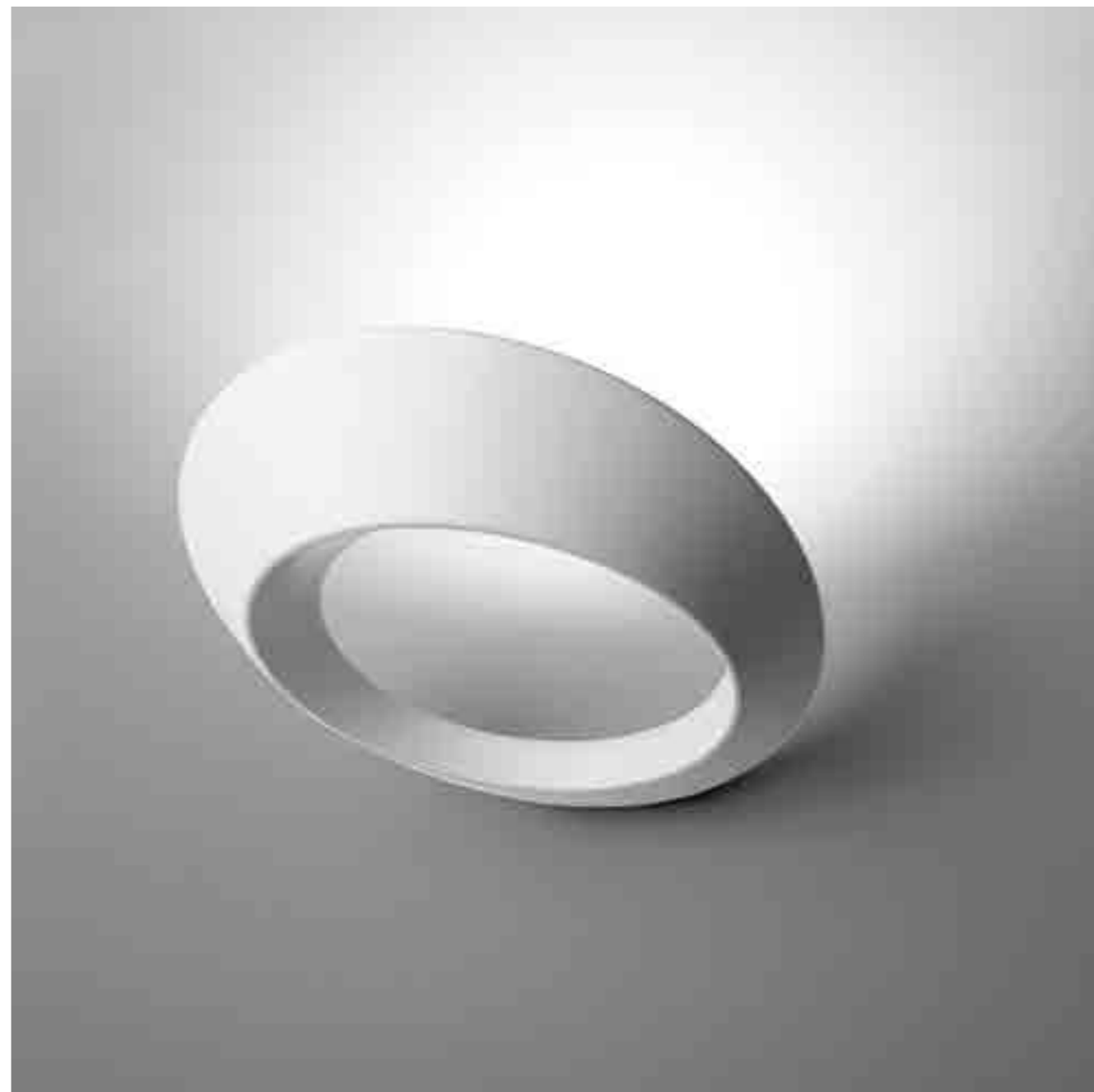

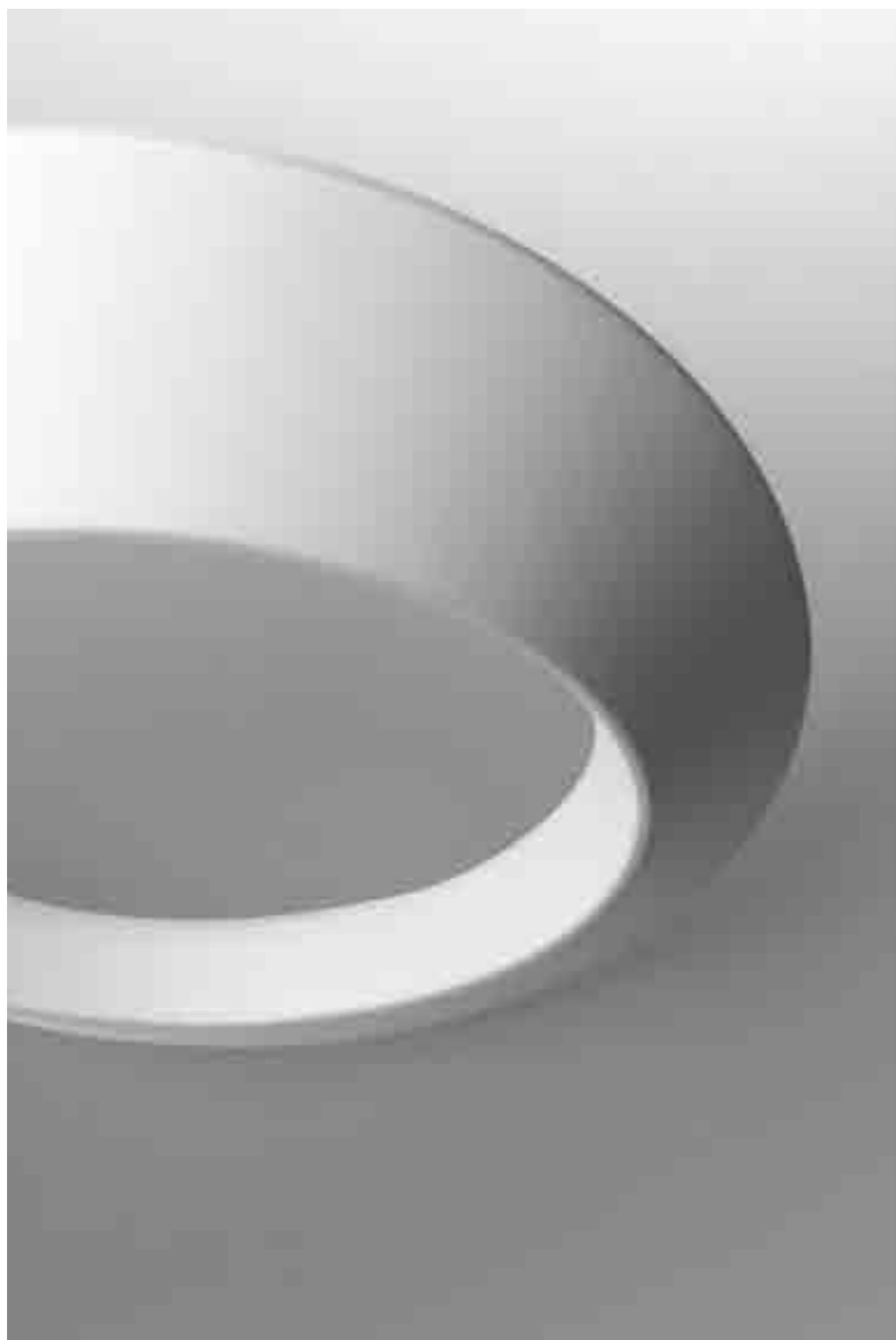

OLO WALL

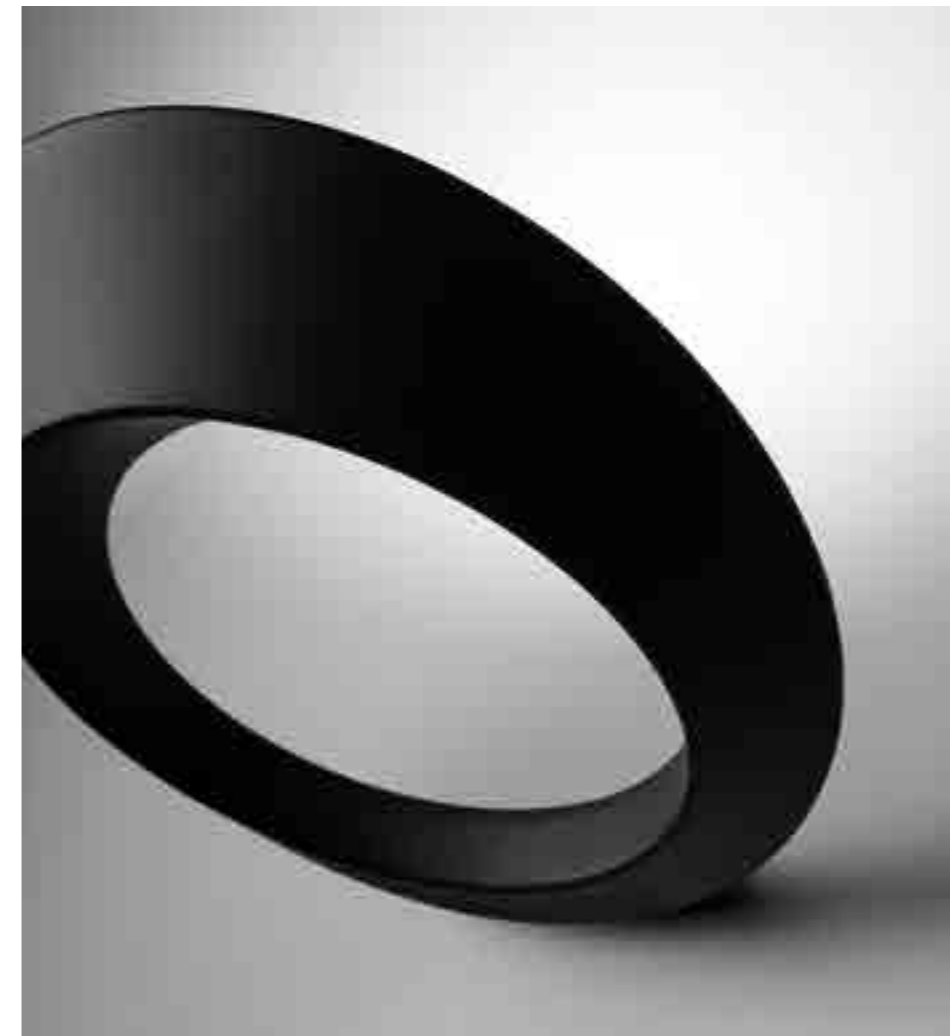



OLO WALL





OLO WALL

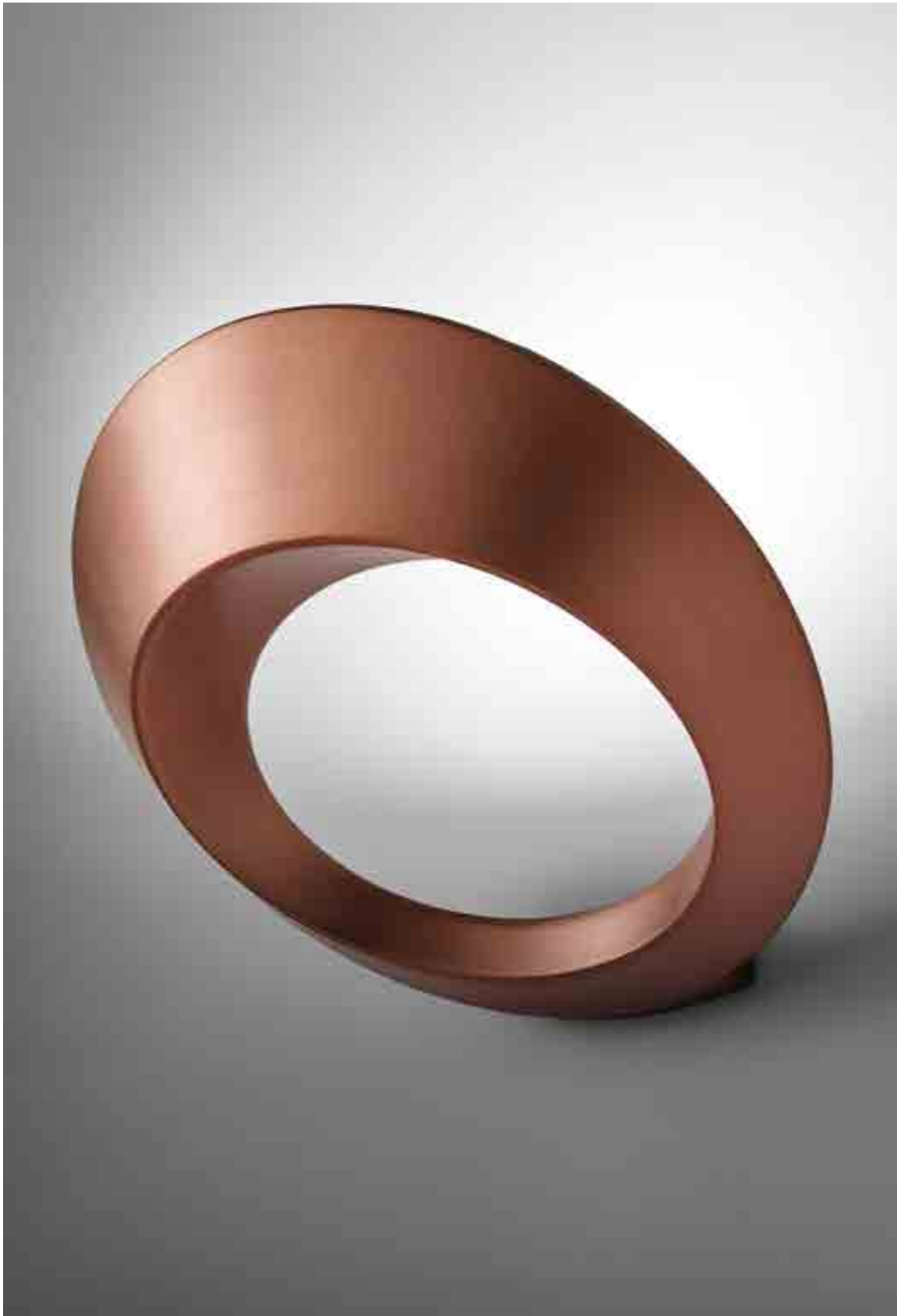



OLO WALL



OLO WALL



OLO WALL





OLO WALL



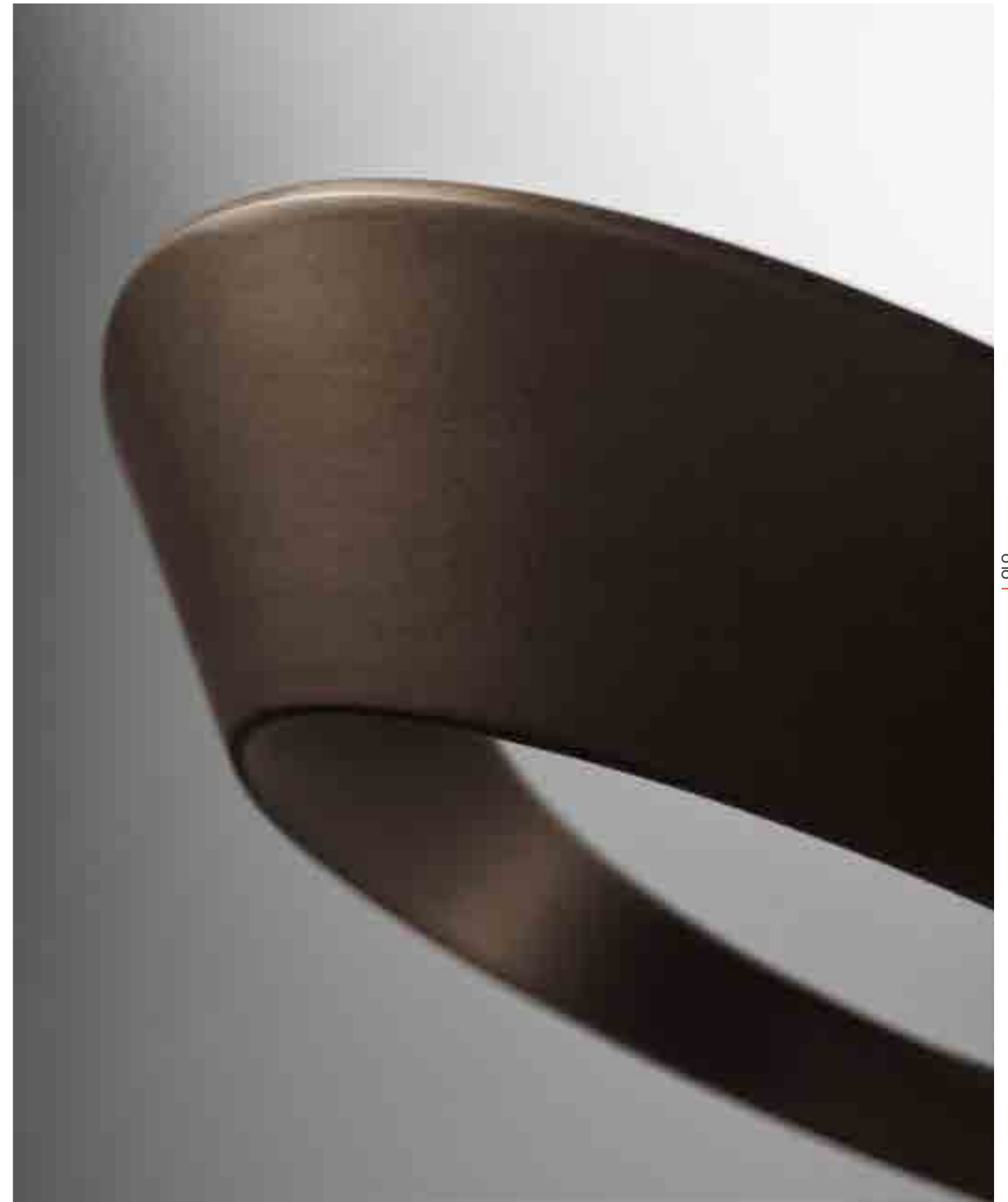

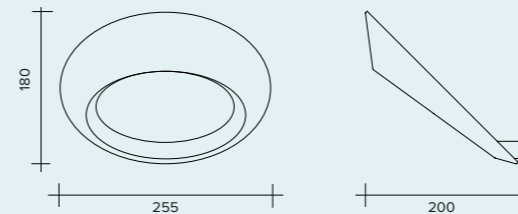
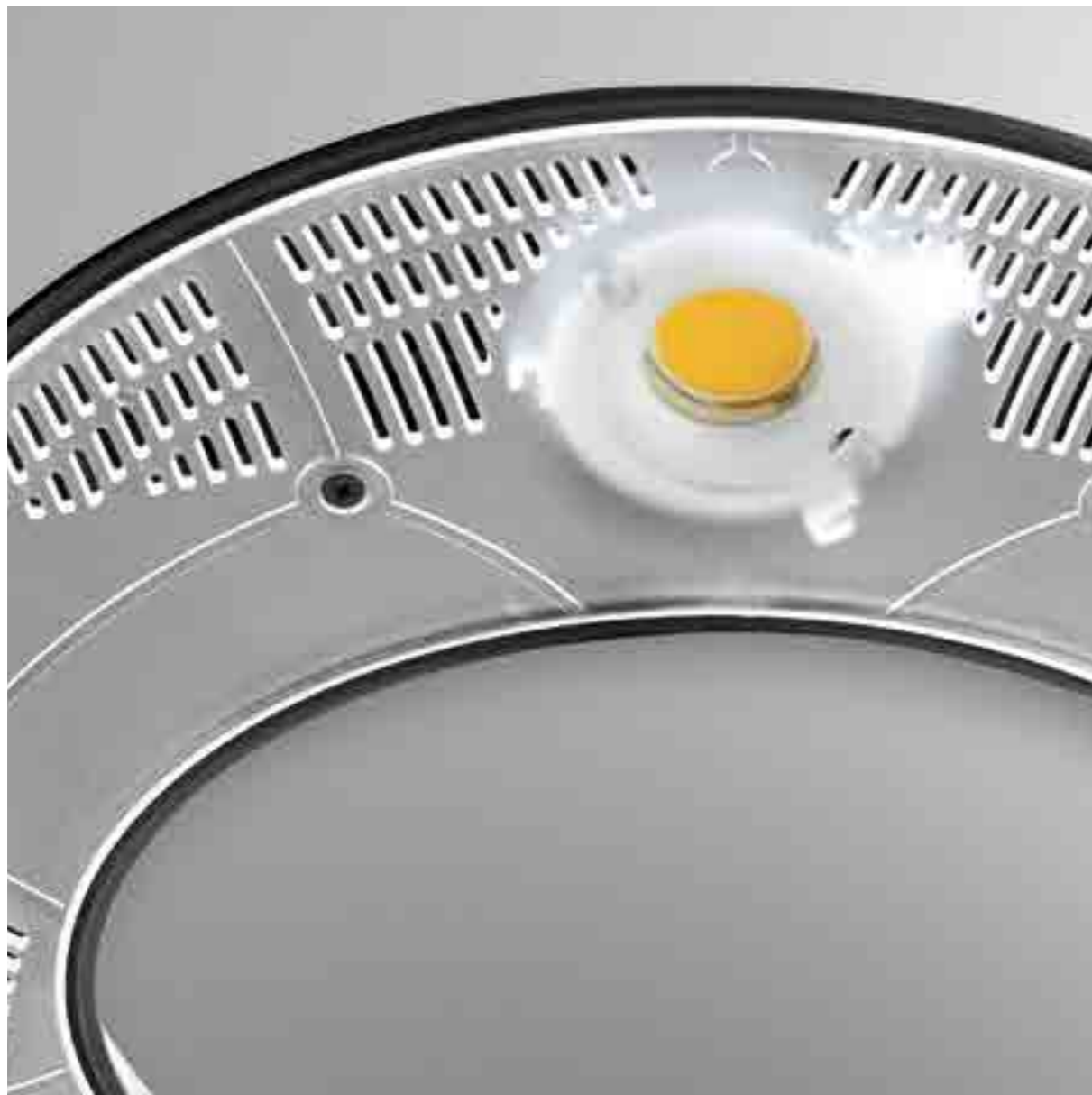

OLO

Wall

Lampada da parete
Wandleuchte
Lámpara de pared
Настенная лампа



FINISHES / FINITURE / FARBE / ACABADOS / ОТДЕЛКИ

- | | | |
|--|---|---|
| ● White / Bianco / Weiß
Blanco / Белый цвет | ● Black / Nero / Schwarz
Negro / Чёрный цвет | ● Brushed gold / Oro spazzolato / Gold gebürstet
Oro cepillado / Брашированное золото |
| ● Brushed copper / Rame spazzolato
Kupfer gebürstet / Cobre cepillado /
Брашированная медь | ● Brushed bronze / Bronzo spazzolato
Bronze gebürstet / Bronce cepillado
Брашированная бронза | ● Brushed black nickel / Nichel nero spazzolato
Nickel schwarz gebürstet / Níquel negro cepillado
Брашированный черный никель |

LIGHT SOURCE / SORGENTE / LICHTQUELLE / FUENTE LUMINOSA / ИСТОЧНИК СВЕТА

LED 33W - 230V 2700°K / 3085 lumen
3000°K / 3300 lumen
4000°K / 3515 lumen

RECOMMENDED DIMMER SWITCHES / DIMMER CONSIGLIATI / EMPFOHLENE DIMMER / REGULADORES DE INTENSIDAD ACONSEJADOS / РЕКОМЕНДУЕМЫЕ ДИММЕРЫ

code 1776.CASAMBI

Bluetooth dimmer, controls up to 4 lights, remote installation.
Dimmer Bluetooth, gestisce fino a 4 lampade, installazione in remoto.
Bluetooth-Dimmer, verwaltet bis zu 4 Lampen, Ferninstallation.
Regulador de intensidad luminosa Bluetooth, para el control de hasta 4 lámparas, instalación a distancia.
диммер bluetooth, позволяющий подключить до 4 ламп, удаленная установка.

code 1776.DIM

Phase cut dimmer, 230V AC, in/out, controls up to 6 lights, adjustable minimum setting, remote installation.
Dimmer a taglio di fase 230vac, in/out, gestisce fino a 6 lampade, minimo programmabile, installazione in remoto.
Phasendimmer 230Vac, Ein-/Ausgang, verwaltet bis zu 6 Lampen, Minimum programmierbar, Ferninstallation.
Regulador de intensidad luminosa por corte de fase 230 Vca, in/out, para el control de hasta 6 lámparas, mínimo programable, instalación a distancia.
диммер с отсечкой фазы 230В перем. тока, вход/выход, позволяющий подключить, до 6 ламп; минимальный уровень диммирования программируемый, удаленная установка.

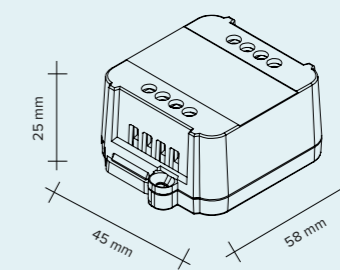
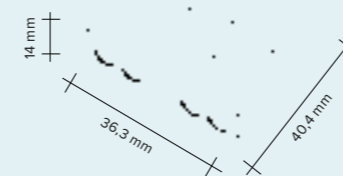

HOLE COVER / COPRIFORO / LOCHABDECKUNG / TAPAORIFICIO / ЗАГЛУШКА

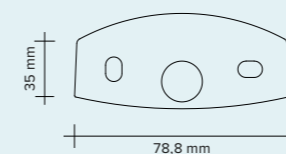

Wall hole cover plate in metal, painted white.
Supplied standard, used for installations on walls with large sized holes.
Piastrina copriforo parete in metallo, verniciata bianca. Fornita di serie, utile per installazioni su pareti con fori di grandi dimensioni.
Lochabdeckung für Wände, aus Metall, weiß lackiert. Wird serienmäßig mitgeliefert und ist nützlich bei einer Installation an der Wand, wenn das Loch einen großen Durchmesser hat.
Placa tapaorificio de metal para pared, pintada de blanco.
Suministrada de serie, útil para instalaciones en paredes con orificios grandes.
Металлическая накладка для покрытия настенных отверстий, окрашенная в белый цвет. Накладка входит в комплект поставки и хорошо подходит для установки на стены с отверстиями большого размера.

ANELLO

SUSPENSION

design Sforzin Illuminazione

ANELLO COLLECTION

The purest form in its most minimal declination.
A perfect circle described in space by a thin, precise, aluminum body.
A continuous thread of light, inside the circle, illuminates the environment consistently, always with discretion.
A dimmable version is also available.

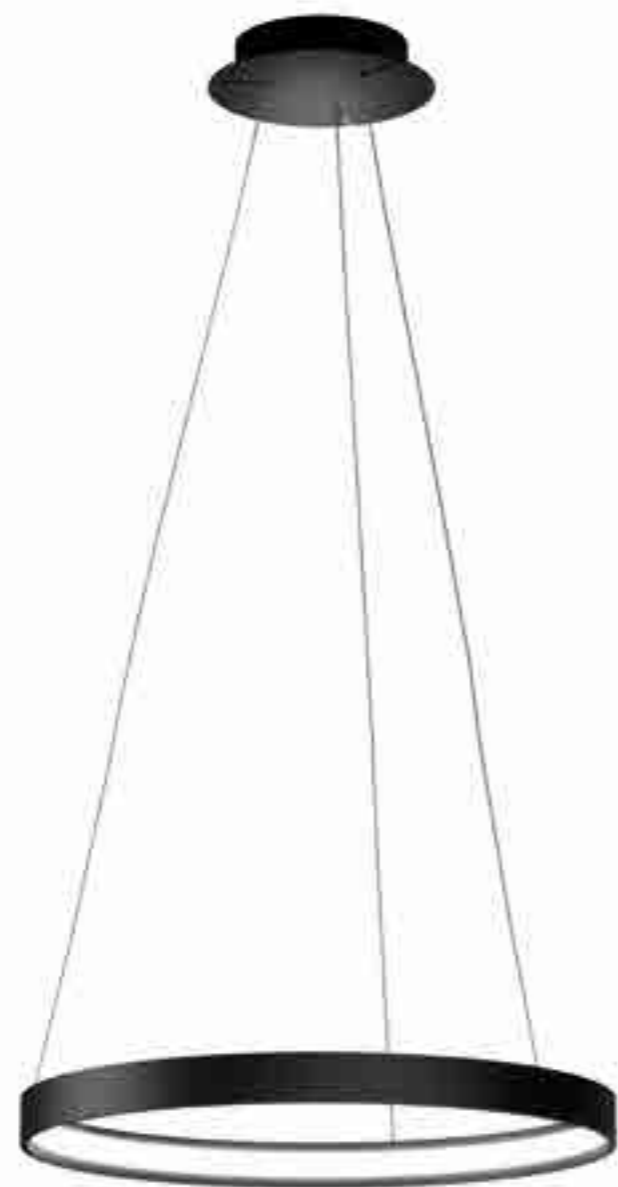

ANELLO

La forma più pura nella sua declinazione più minimale.
Un cerchio perfetto descritto nello spazio da un sottile, preciso, corpo in alluminio.
Un filo continuo di luce, interno al cerchio, illumina l'ambiente uniformemente, sempre con discrezione.
Disponibile anche in versione dimmerabile.

ANELLO

Die reinste Form in ihrer schlichtesten Ausführung.
Ein perfekter Kreis der im Raum durch einen dünnen, präzisen Aluminiumkörper definiert wird.
Ein durchgehender Lichtfaden im Inneren des Kreises beleuchtet die Umgebung gleichmäßig und immer diskret.
Version erhältlich.

ANELLO

La forma más pura en su más mínima declinación.
Un cuerpo de aluminio fino y preciso describe en el espacio un círculo perfecto.
Un hilo de luz continuo, dentro del círculo, ilumina uniformemente el lugar, siempre con discreción.
Disponibile también en la versión con intensidad luminosa regulable.

ANELLO

Самая чистая форма в самом минималистическом виде
Идеально ровный круг, выделенный в пространстве тонким и точным алюминиевым корпусом.
Непрерывный поток света, внутри круга, равномерно и всегда умеренно освещает помещение.
Предлагается и диммируемый вариант.



ANELLO SUSPENSION





ANELLO SUSPENSION



ANELLO

SUSPENSION

design Sforzin Illuminazione



ANELLO

ANELLO SUSPENSION

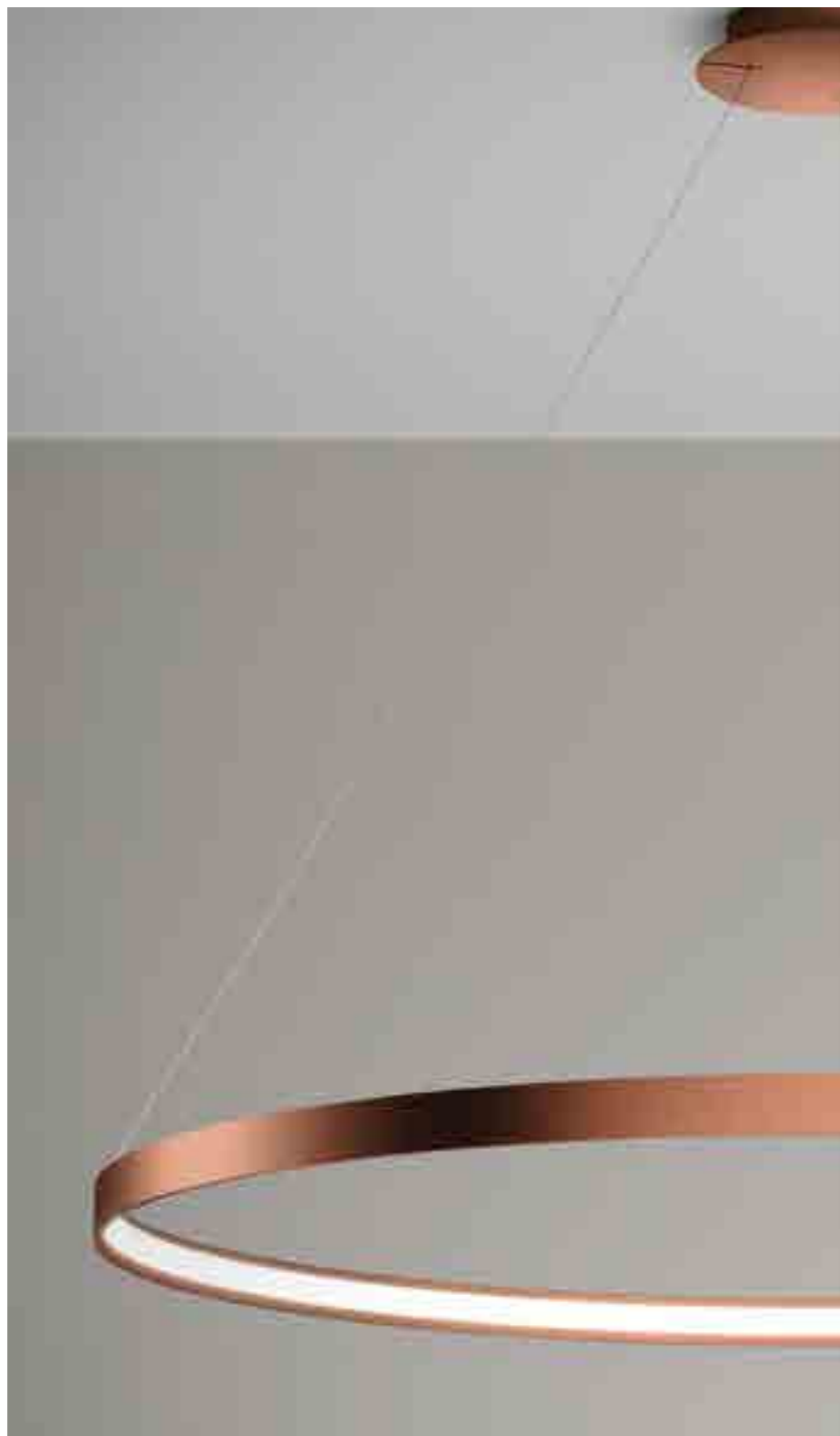

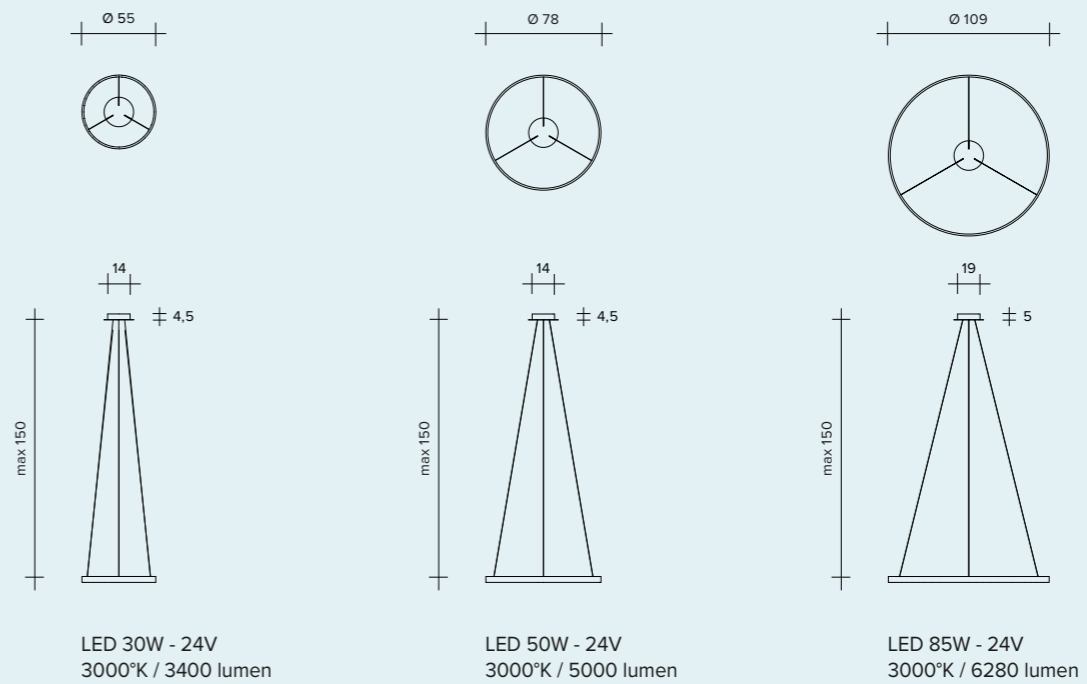

ANELLO Suspension

Lampada a sospensione
Pendelleuchte
Lámpara colgante
Подвесная лампа

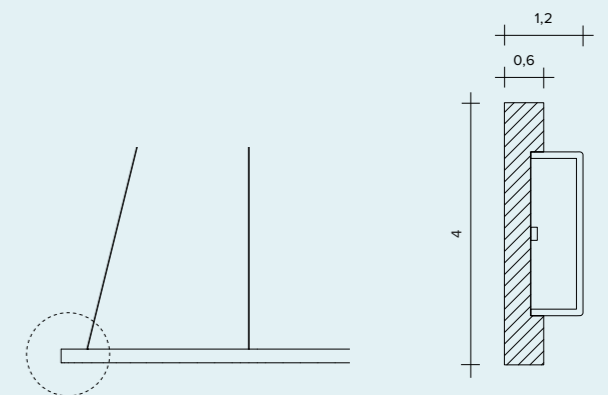

FINISHES / FINITURE / FARBE / ACABADOS / ОТДЕЛКИ

- Painted black / Nero Verniciato / Schwarz lackiert
Negro Pintado / Окрашенный в черный цвет
- Brushed Bronze / Bronzo Spazzolato / Bronze gebürstet
Bronce cepillado / Брашированная бронза
- Brushed Gold / Oro Spazzolato / Gold gebürstet
Oro cepillado / Брашированное золото
- Brushed Copper / Rame Spazzolato / Kupfer gebürstet
Cobre cepillado / Брашированная медь

LAMOI

NEW FINISHES

design **Andrea Barra**

LAMOI COLLECTION

Magical collection of LED lamps: suspension lamps, ceiling lights and floor lamps.

The metal, an electrical conductor, is available in four colours (black nickel, chrome, copper or gold) and can be used to supply power to and turn on the 1W LED modules.

Available in 2700°K and 3000°K versions.

Dimmable and non-dimmable, optional cover.

LAMOI COLLEZIONE

Magica collezione di lampade a led: Sospensioni, Plafoniere e Piantane. Il metallo conduttore di corrente, disponibile nei colori nickel nero, cromo, rame, e oro permette di alimentare e accendere i moduli led da 1 w. Disponibili in 2700°K e 3000°K. Dimmerabile e non, coperture optional.

LAMOI KOLLEKTION

Eine magische LED-Leuchten Kollektion: Hängeleuchten, Deckenleuchten und Stehleuchten. Das stromleitende Metall ist in den Farben Nickel schwarz, Chrom, Kupfer und Gold erhältlich und dient zum Speisen und Einschalten der 1W LED-Module. Erhältlich mit 2700°K und 3000°K. Dimmerbar und nicht dimmerbar, Abdeckungen optional.

LAMOI COLECCIÓN

Colección mágica de lámparas de led: De suspensión, plafones y de pie. El metal, conductor de corriente, disponible en los colores níquel negro, cromo, cobre y oro, permite alimentar y encender los módulos led de 1 w. Disponibles con temperaturas de color de 2700°k y 3000°k. De intensidad luminosa regulable y fija, coberturas opcionales.

КОЛЛЕКЦИЯ LAMOI

Волшебная коллекция светодиодных ламп: подвесные, потолочные и опорные. Токпроводящий металл цвета черного никеля, хрома, меди или золота позволяет питать и включать светодиодные модули мощностью 1 Вт. Имеются модели на 2700°K и 3000°K. С диммером и без, крышки не входят в базовую комплектацию.



LAMOI
NEW FINISHES

SUSPENSION



LAMOI

LAMOI
SUSPENSION
NEW FINISHES

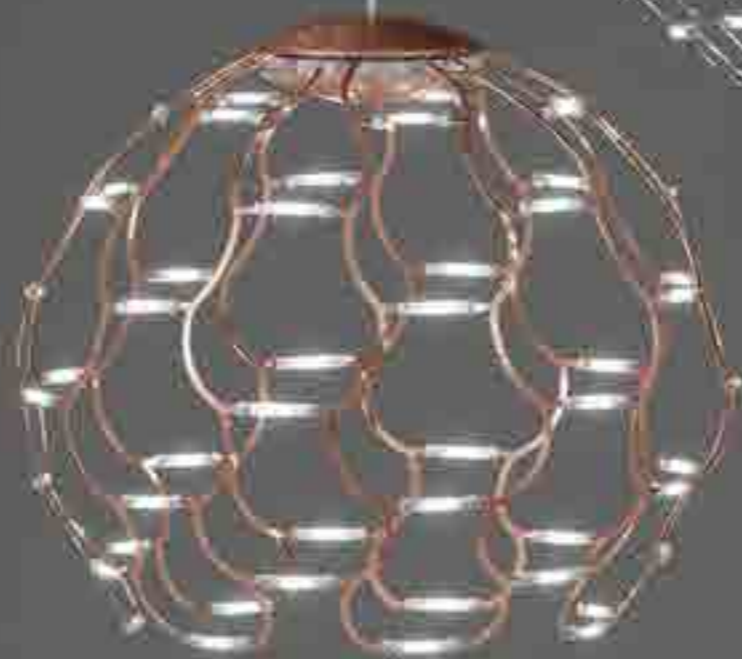
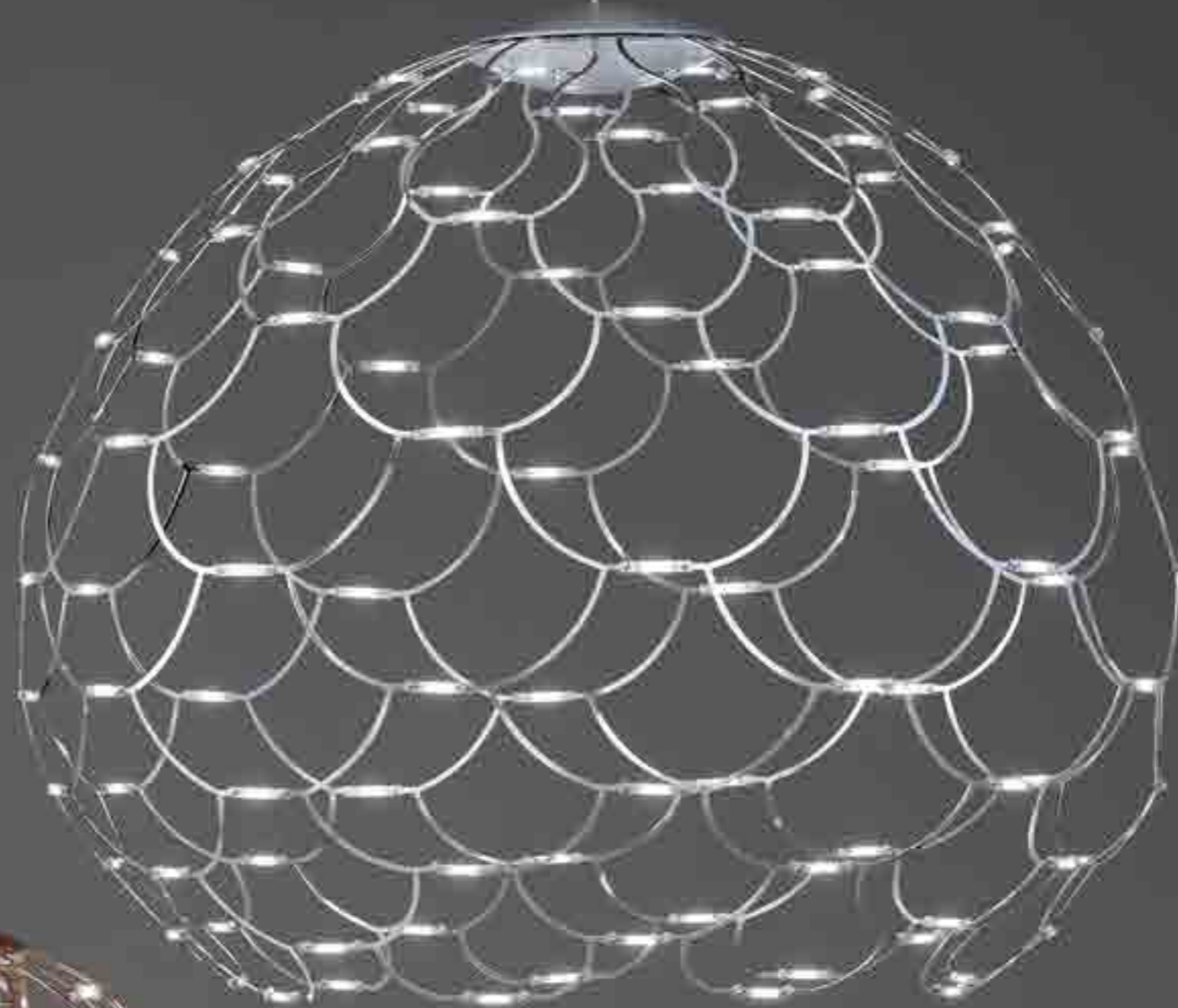
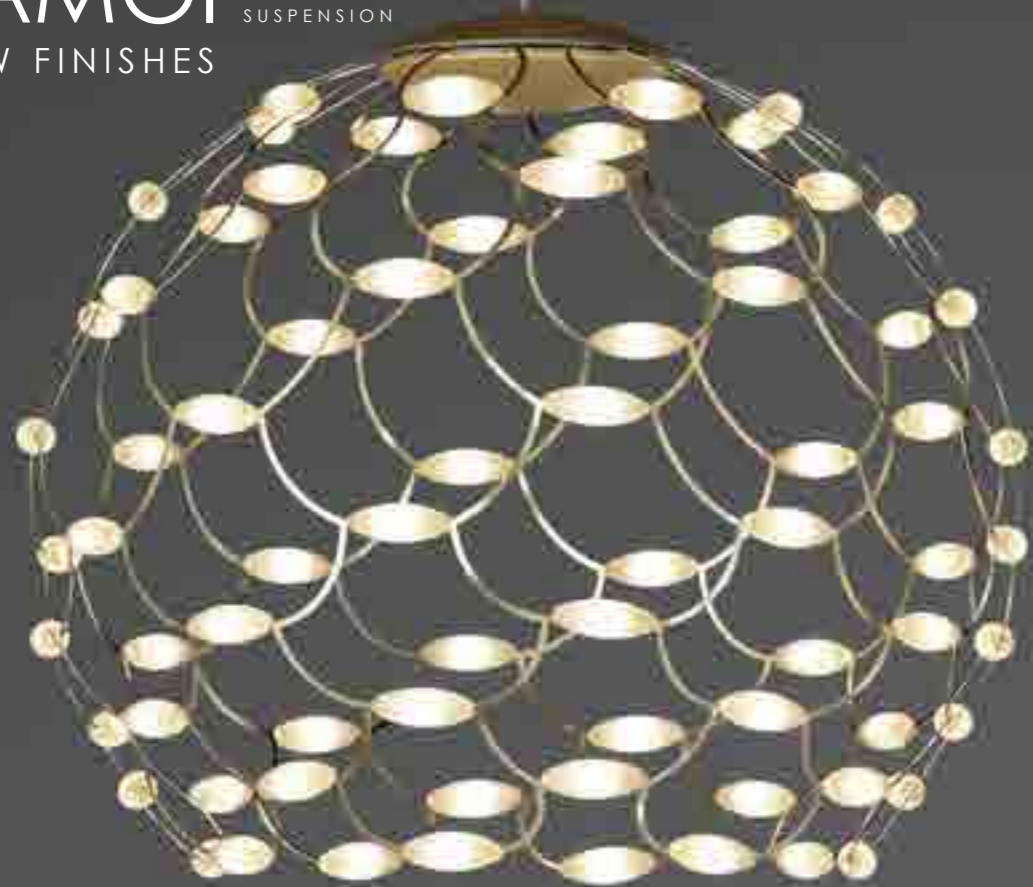

LAMOI SUSPENSION
NEW FINISHES





LAMOI SUSPENSION
NEW FINISHES



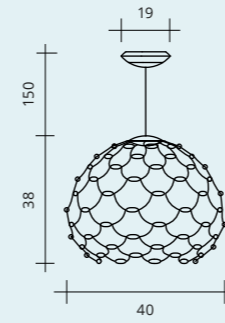
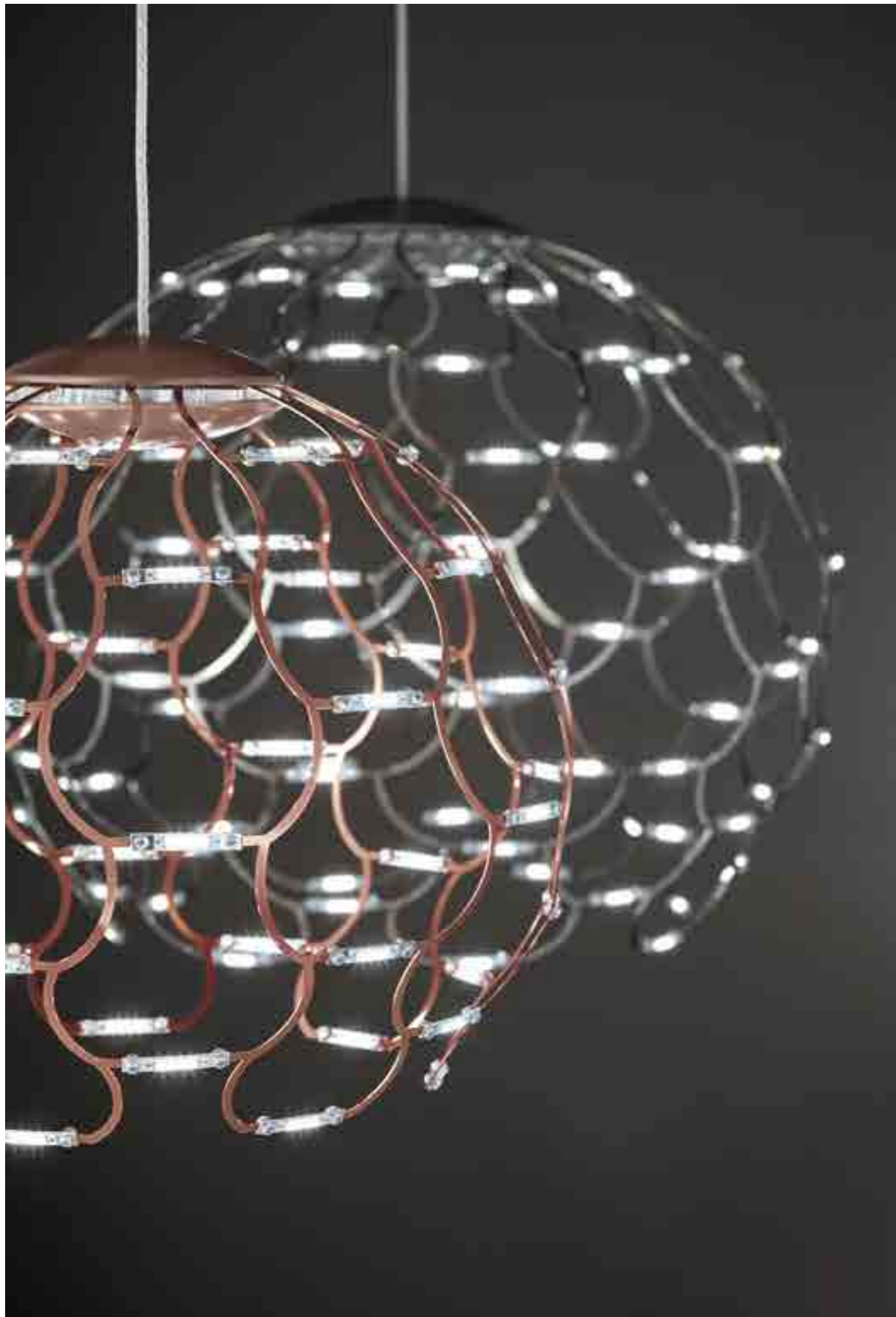

LED 49W - 24V
2700°K / 3675 lumen
3000°K / 3920 lumen

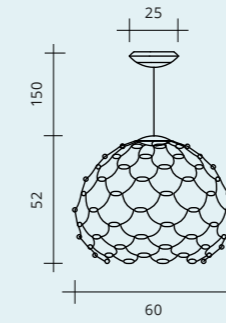

LED 72W - 24V
2700°K / 5400 lumen
3000°K / 5760 lumen

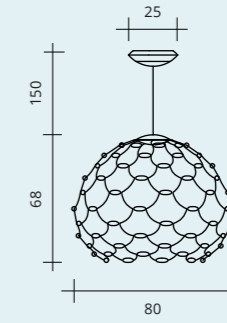

LED 99W - 24V
2700°K / 7425 lumen
3000°K / 7920 lumen

LAMOI

Suspension

Lampada a sospensione

Pendelleuchte

Lámpara colgante

Подвесная лампа



FINISHES / FINITURE / FARBE / ACABADOS / ОТДЕЛКИ

- Copper / Rame / Kupfe / Cobre / Медь
- Chrome / Cromo / Chrom / Cromo / Хром
- Black / Nero / Schwarz / Negro / Чёрный цвет
- Gold / Oro / Kupfe / Gold / Золото

LAMOI
NEW FINISHES

CEILING





LAMOI CEILING
NEW FINISHES



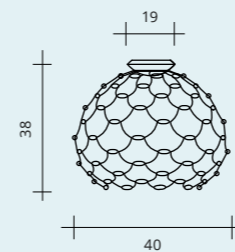
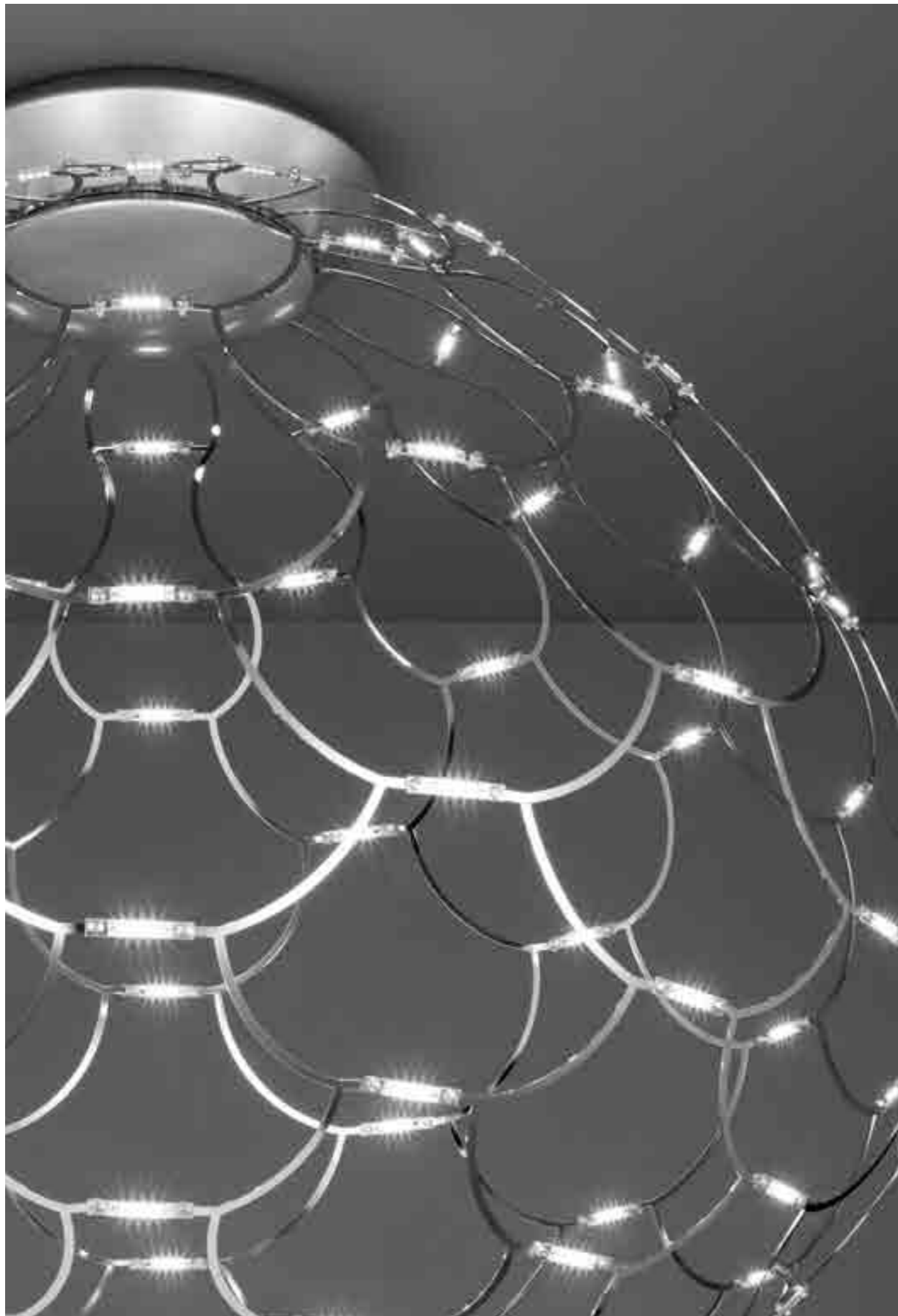

LED 49W - 24V
2700°K / 3675 lumen
3000°K / 3920 lumen

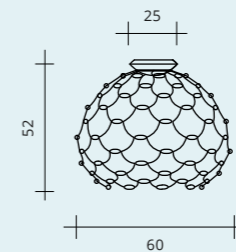

LED 72W - 24V
2700°K / 5400 lumen
3000°K / 5760 lumen

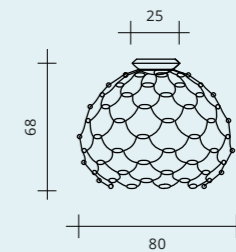

LED 99W - 24V
2700°K / 7425 lumen
3000°K / 7920 lumen

LAMOI Ceiling light

Lampada da soffitto
Deckenleuchte
Lámpara de techo
Потолочная лампа



FINISHES / FINITURE / FARBE / ACABADOS / ОТДЕЛКИ

- Copper / Rame / Kupfe / Cobre / Медь
- Chrome / Cromo / Chrom / Cromo / Хром
- Black / Nero / Schwarz / Negro / Чёрный цвет
- Gold / Oro / Kupfe / Gold / Золото

LAMOI

FLOOR LAMP
NEW FINISHES

Picture shows
the LAMOI Floor
touch dimmer.

*Immagine raffigurante
touch dimmer della
LAMOI Terra.*

*Das Bild zeigt den
Touch Dimmer des LAMOI
Stehleuchten modells.*

*La imagen muestra
el regulador touch
de luminosidad de la
LAMOI Tierra Cobre.*

*На изображении
представлен сенсорный
диммер светильника
LAMOI Terra.*



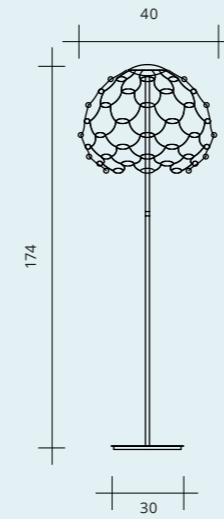
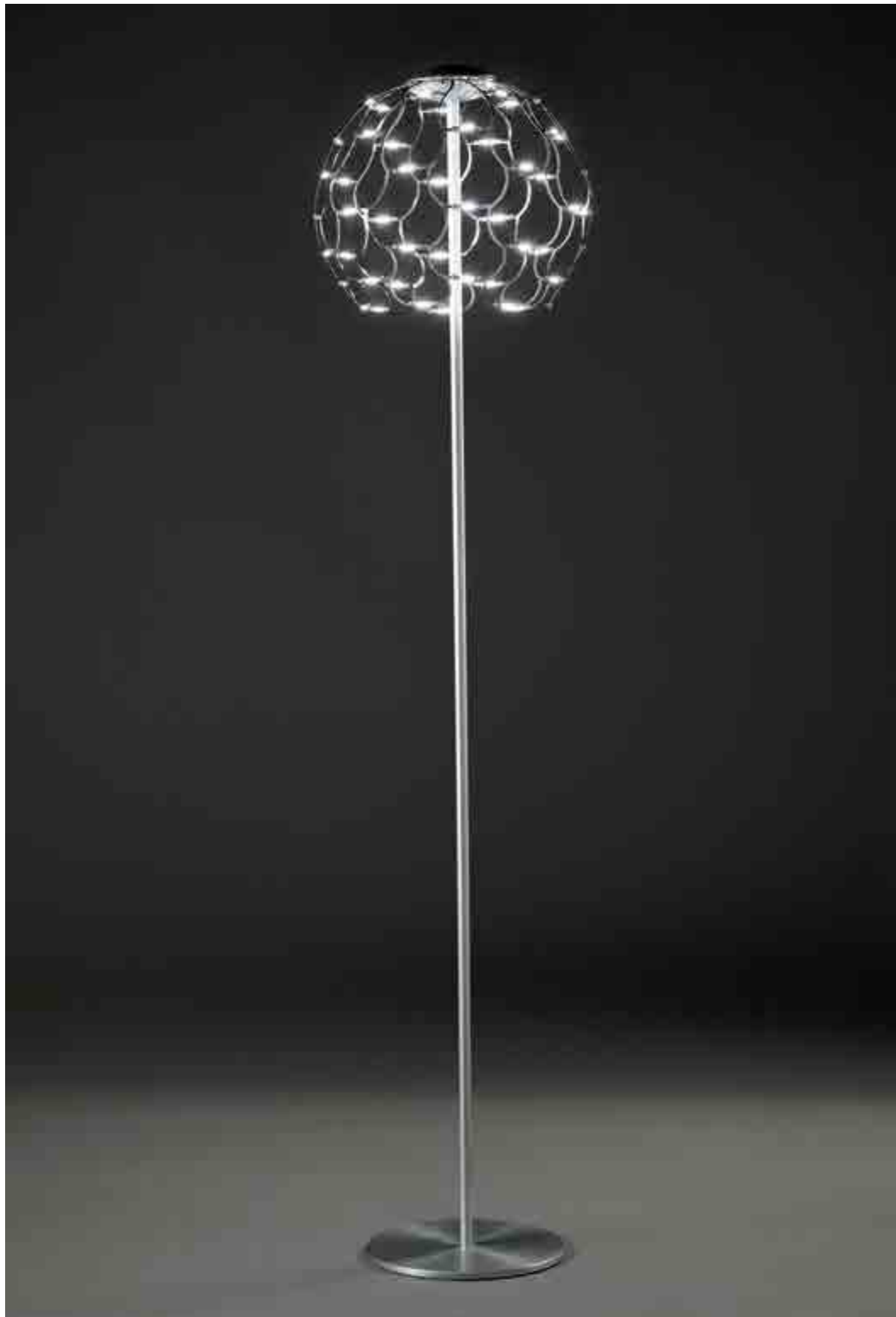

LED 49W - 24V
2700°K / 3675 lumen
3000°K / 3920 lumen

LAMOI Floor lamp

Lampada da terra
Stehleuchte
Lámpara de pie
Напольная лампа



FINISHES / FINITURE / FARBE / ACABADOS / ОТДЕЛКИ

- Copper / Rame / Kupfe / Cobre / Медь
- Chrome / Cromo / Chrom / Cromo / Хром
- Black / Nero / Schwarz / Negro / Чёрный цвет
- Gold / Oro / Kupfe / Gold / Золото

TESA MINI

design Marco Spatti

TESA MINI COLLECTION

A more compact version of the Tesa, its bigger sister. The LED lights and metal frame blend together into a single piece, creating an elegant light of great visual impact.

The design plays on a mix of solids and voids, with glittering sparkles and reflections.

Available in 2700°K and 3000°K versions.

Dimmable and non-dimmable.

Three colours: polished chrome, black nickel and copper.

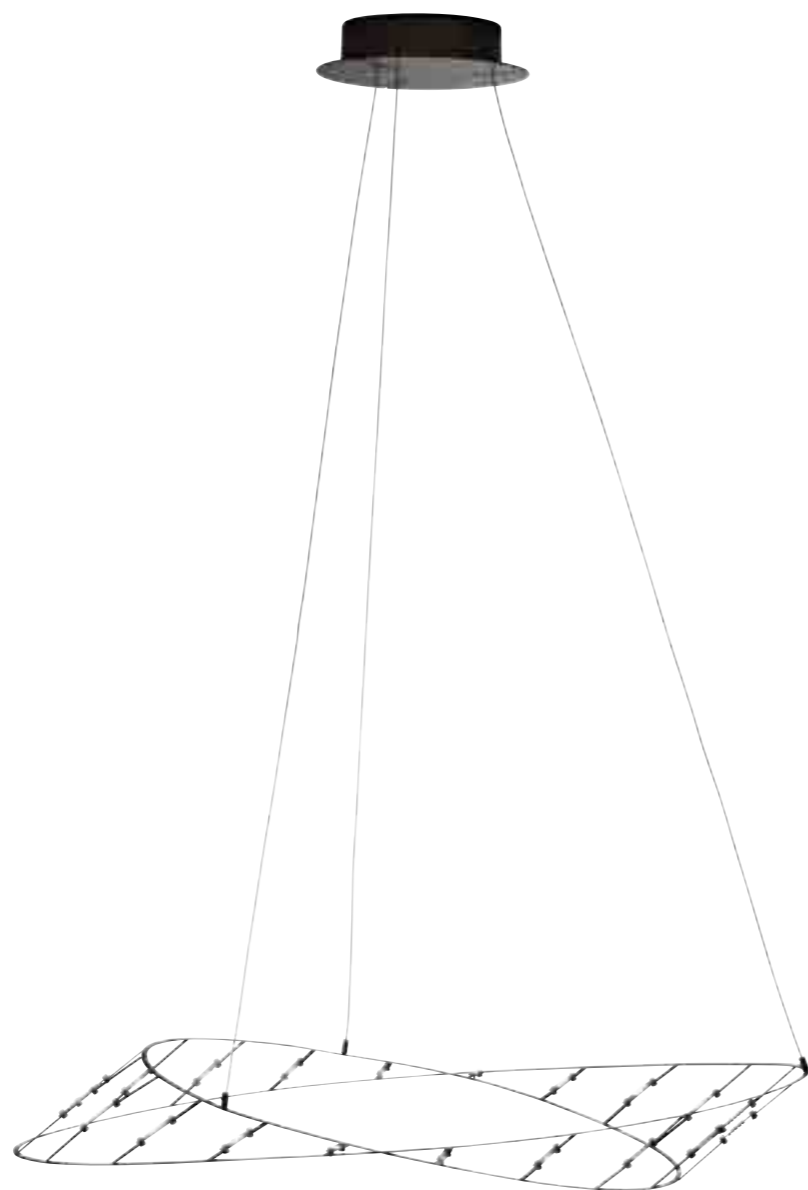

TESA MINI

Versione compatta della sorella maggiore Tesa. Led e struttura metallica si fanno corpo unico dando vita ad una lampada elegante dal grande impatto visivo. Un gioco fatto di pieni e vuoti, di scintillii e riflessi. Disponibile 2700°k e 3000°k. Dimmerabile e non. Tre colori: cromo lucido, nickel nero e rame.

TESA MINI

Kompakte Version der großen Schwester Tesa. Led und Metallstruktur werden zu einem einzigen Körper und kreieren eine elegante Lampe mit großer optischer Wirkung. Ein Spiel aus vollen und leeren Räumen, Funken und Reflexionen. Erhältlich mit 2700 °K und 3000 °K. Dimmbar und nicht dimmbar. Drei Farben: poliertes Chrom, schwarzes Nickel und Kupfer.

TESA MINI

Versión compacta de la hermana mayor Tesa. Led y estructura metálica forman un cuerpo único, creando una lámpara elegante de gran impacto visual. Un juego de lleno y vacío, de centelleos y reflejos. Disponibles 2700°k y 3000°k. Intensidad luminosa fija y regulable. Tres colores: cromo brillante, níquel negro y cobre.

TESA MINI

Компактный вариант более импозантной модели Tesa. Светодиод и металлическая конструкция становятся единым корпусом, создавая элегантный и очень эффектный светильник. Игра полных и пустых объемов, мерцания и отражения. Существует два варианта: 2700 К и 3000 К. Диммируемый и недиммируемый. Три цвета: блестящий хром, черный никель и медь.





TESA MINI SUSPENSION

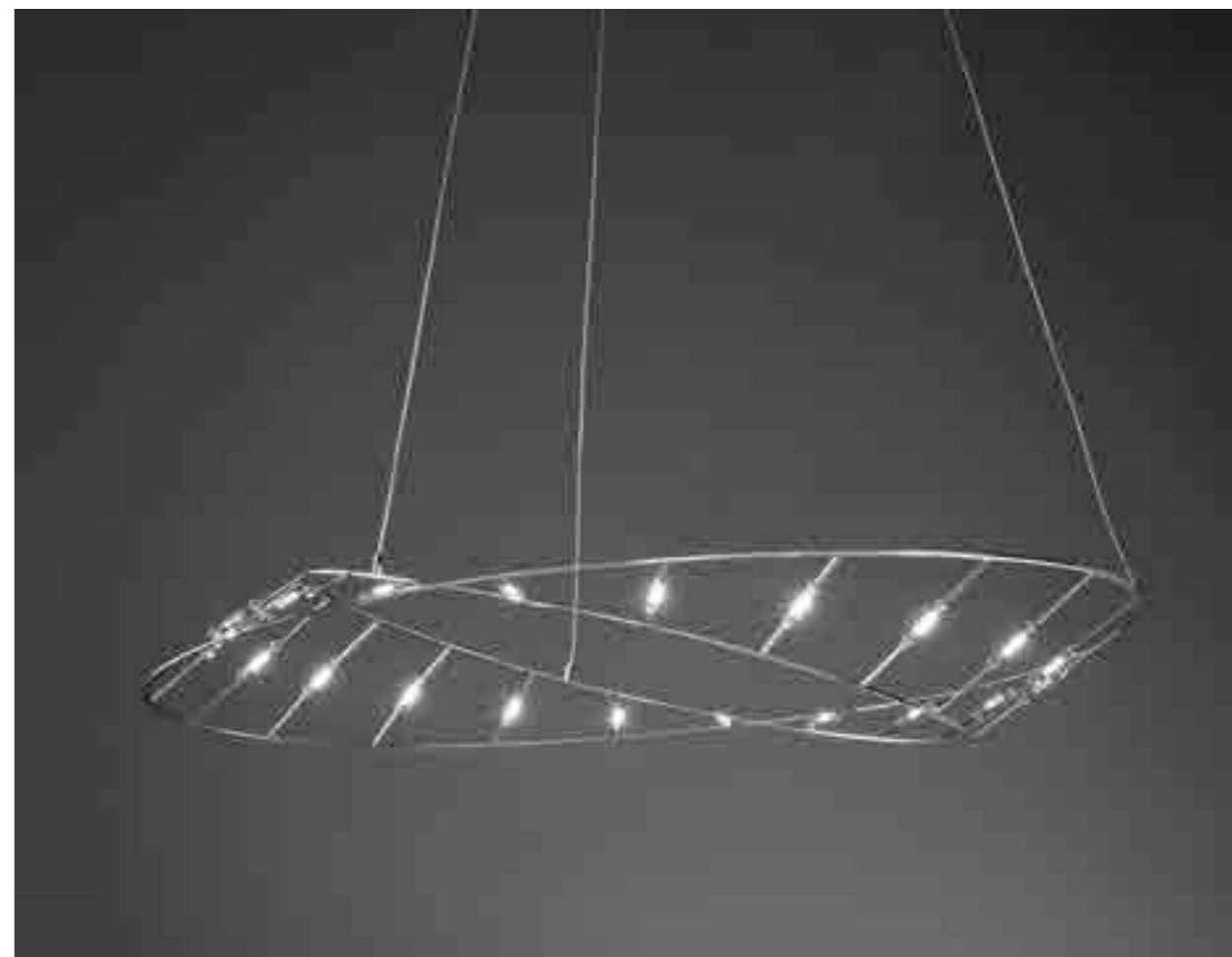

TESA MINI SUSPENSION

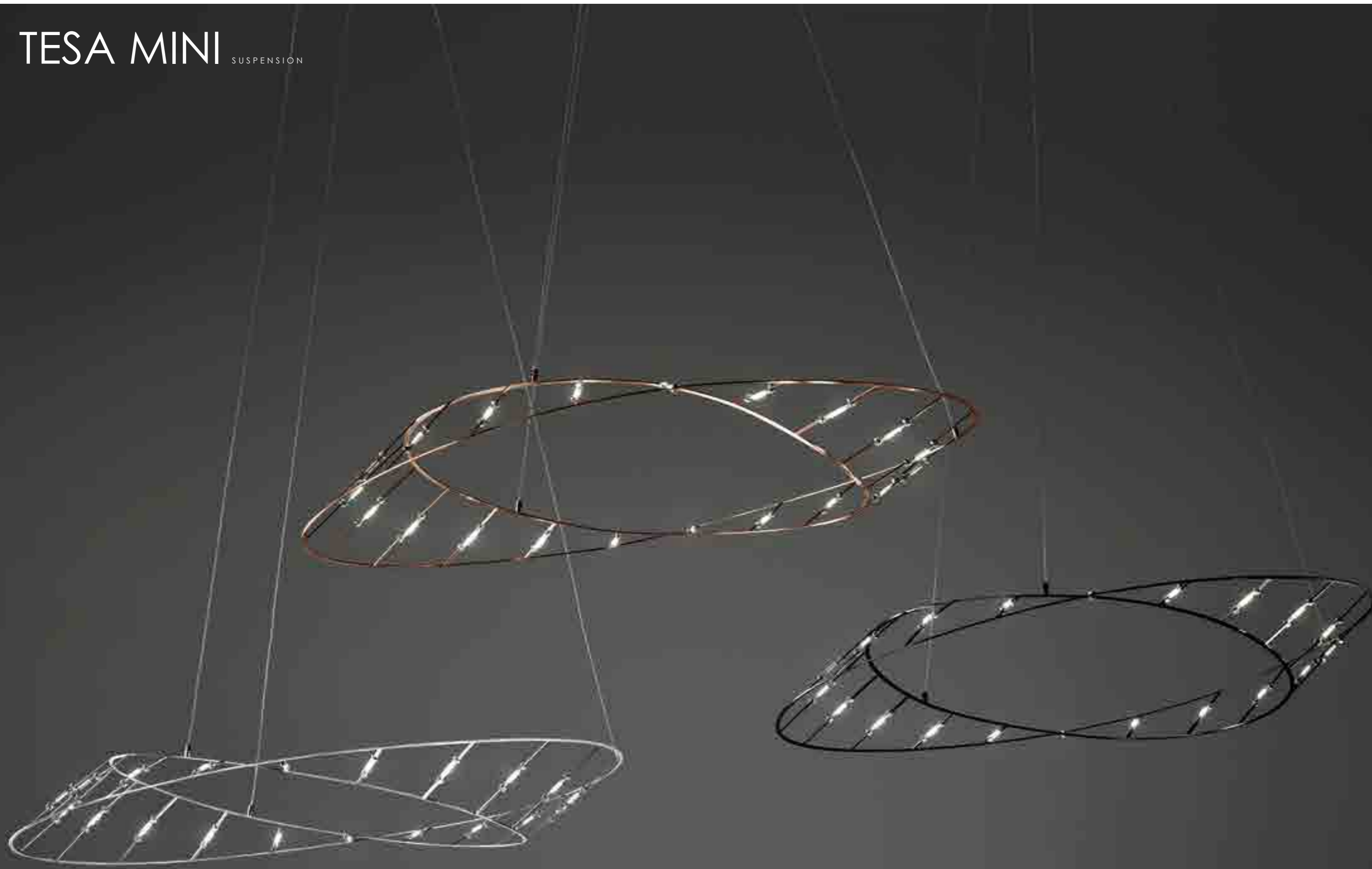

TESA MINI CEILING

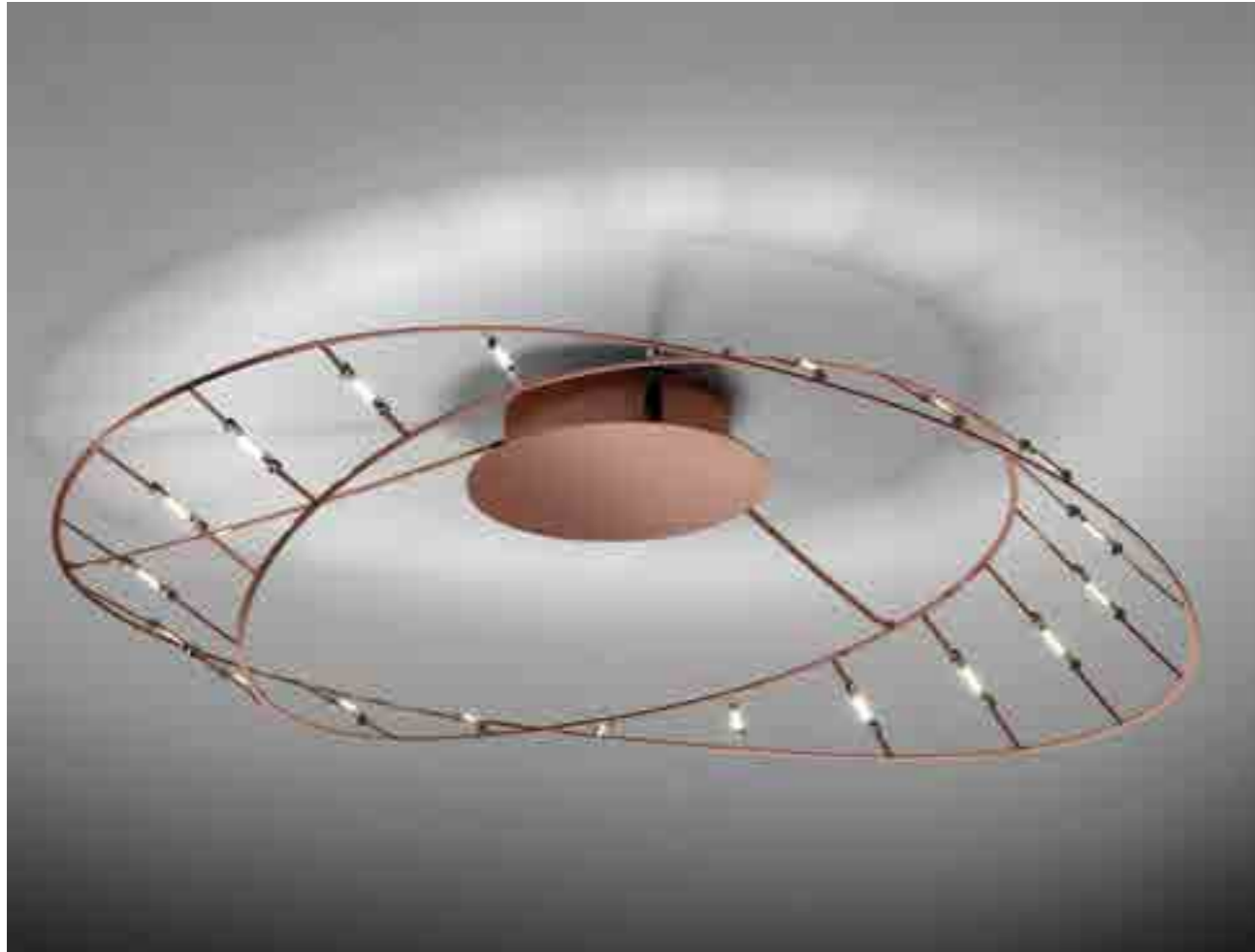

TESA MINI CEILING

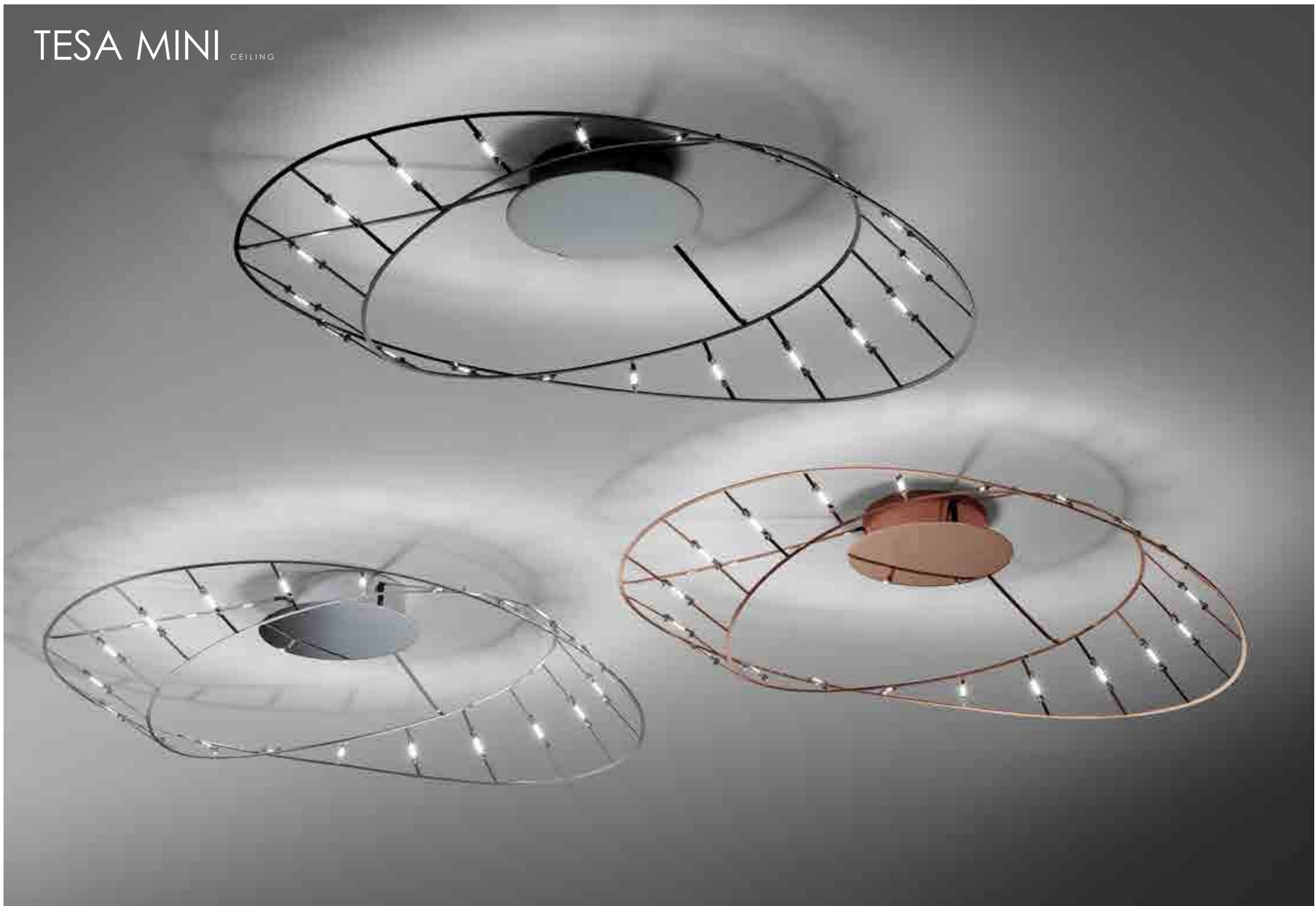

TESA MINI CEILING

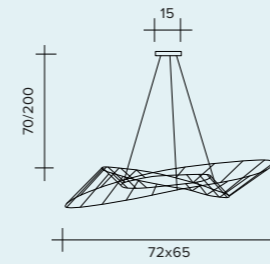
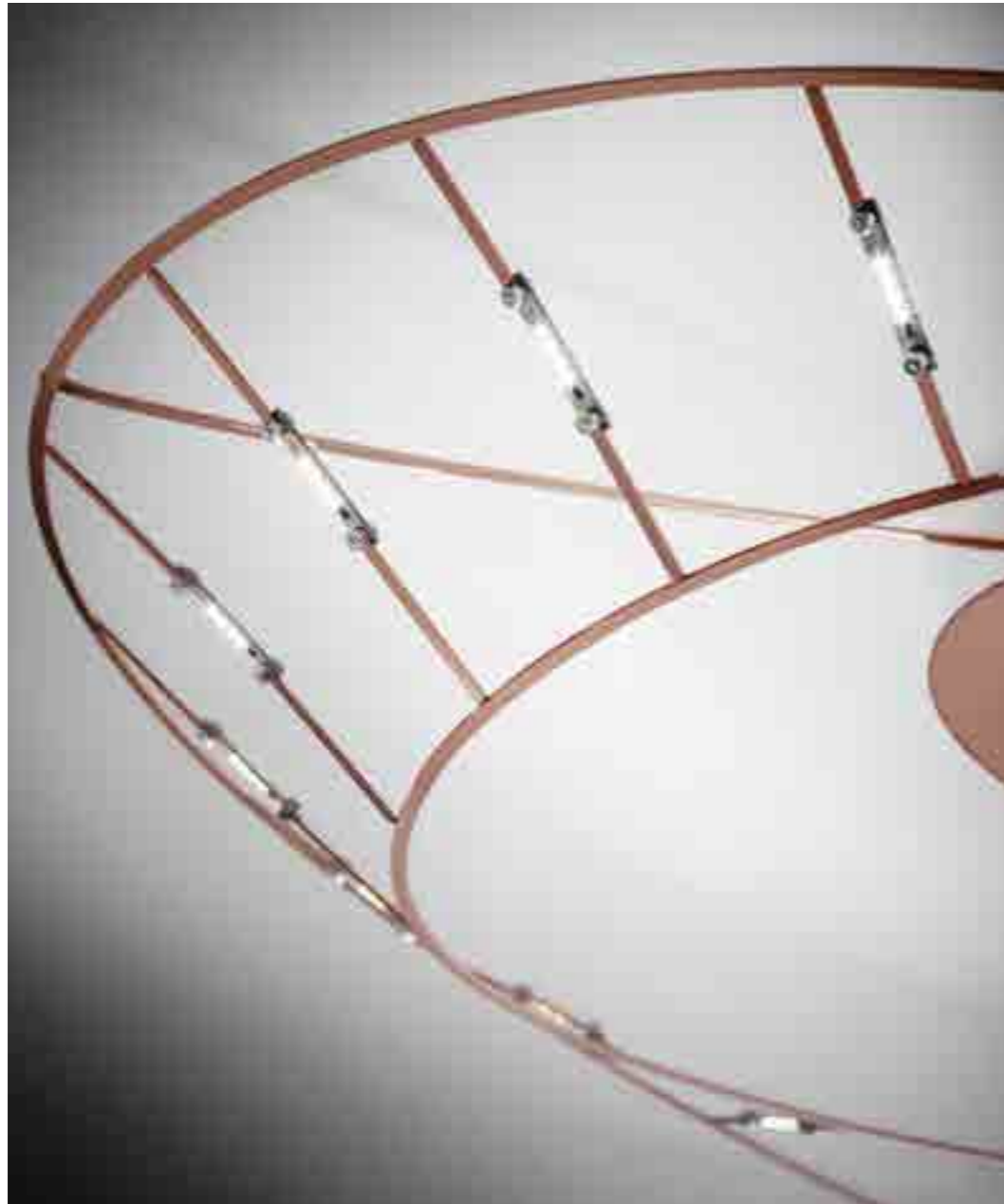

LED 20W - 24V
2700°K / 1700 lumen
3000°K / 1900 lumen

TESA MINI Suspension

Lampada a sospensione
Pendelleuchte
Lámpara colgante
Подвесная лампа



FINISHES / FINITURE / FARBE / ACABADOS / ОТДЕЛКИ

- Chrome / Cromo / Chrom
Cromo / Хром
- Black / Nero / Schwarz
Negro / Чёрный цвет
- Copper / Rame / Kupfe
Cobre / Медь

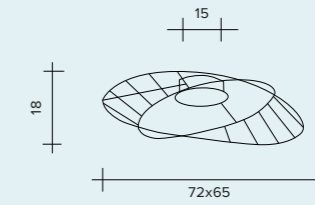

LED 20W - 24V
2700°K / 1700 lumen
3000°K / 1900 lumen

TESA MINI Ceiling

Lampada da soffitto
Deckenleuchte
Lámpara de techo
Потолочная лампа



FINISHES / FINITURE / FARBE / ACABADOS / ОТДЕЛКИ

- Chrome / Cromo / Chrom
Cromo / Хром
- Black / Nero / Schwarz
Negro / Чёрный цвет
- Copper / Rame / Kupfe
Cobre / Медь

TESA

design Marco Spatti

TESA

A lighting fixture with geometric lines. The curves of the metal give "Tesa" a balanced and harmonious look. The metal, an electrical conductor, is available in three colours (black nickel, chrome or copper) and can be used to supply power to and turn on the 1W LED modules. Available in 2700°K and 3000°K versions. Dimmable and non-dimmable.

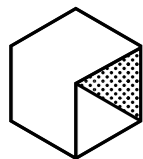

archiproducts

DESIGN AWARDS 2017

TESA

Linee geometriche per un oggetto illuminante. La curvatura del metallo rende "Tesa" equilibrata e armonica. Il metallo, conduttore di corrente, disponibile nei colori nickel nero, cromo e rame, permette di alimentare e accendere i moduli led da 1w. Disponibile 2700°k e 3000°k. Dimmerabile e non.

TESA

Ausgeglichenheit und Harmonie. Das stromleitende Metall ist in den Farben Nickel schwarz, Chrom und Kupfer erhältlich und dient zum Speisen und Einschalten der 1W Led-Module. Erhältlich mit 2700°K und 3000°K. Dimmerbar und nicht dimmerbar.

TESA

Líneas geométricas para un objeto iluminador. La curvatura del metal hace de "Tesa" un objeto equilibrado y armónico. El metal, conductor de corriente, disponible en los colores níquel negro, cromo y cobre, permite alimentar y encender los módulos led de 1 w. Disponible con temperaturas de color de 2700°k y 3000°k. De intensidad luminosa regulable y fija.

TESA

Геометрические линии в дизайне светильника. Изгибы металлических частей придают приборам "Tesa" сбалансированный и гармоничный вид. Токпроводящий металл цвета черного никеля, хрома и меди позволяет питать и включать светодиодные модули 1 Вт. Имеются модели на 2700°K и 3000°K. С диммером и без.

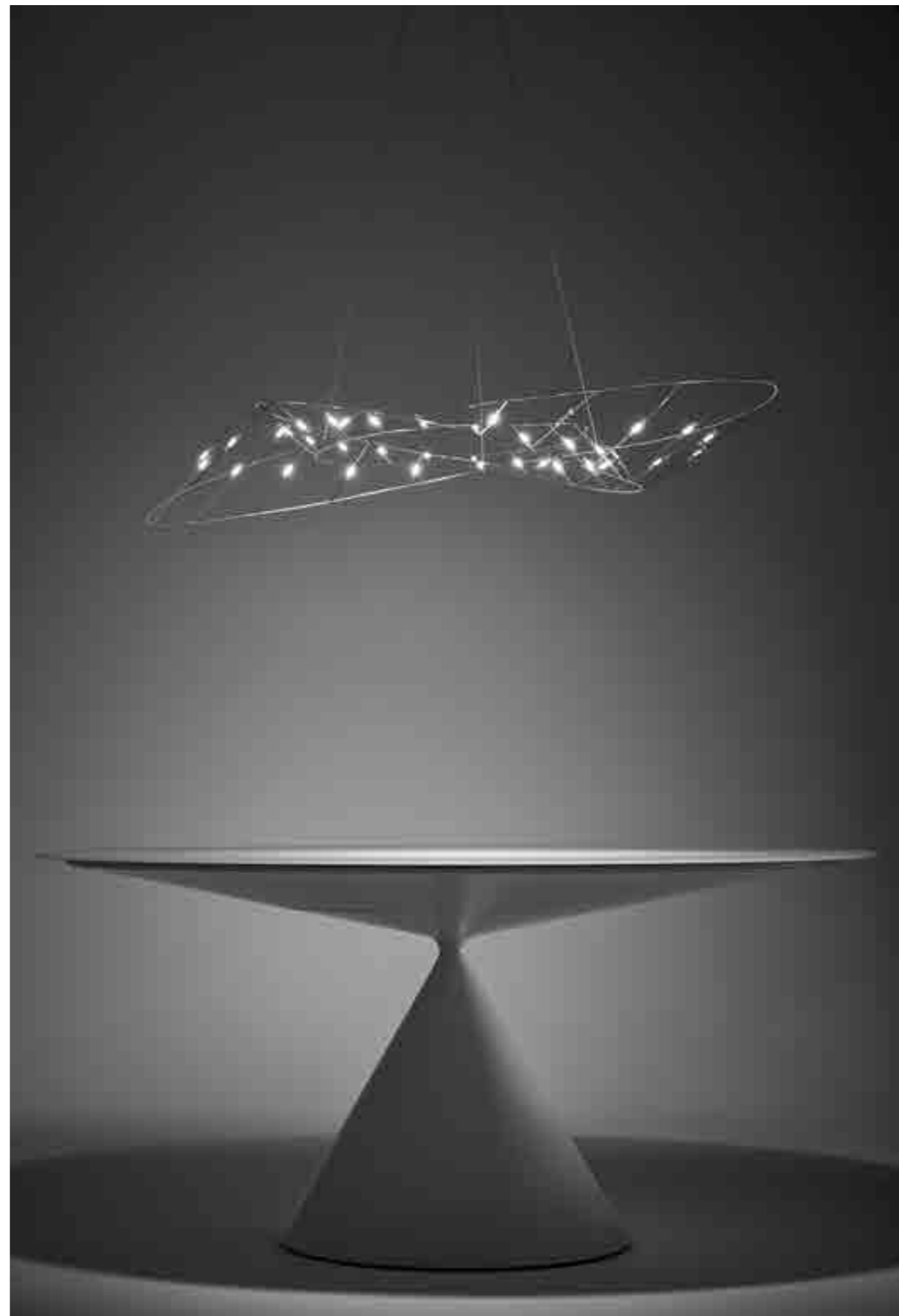

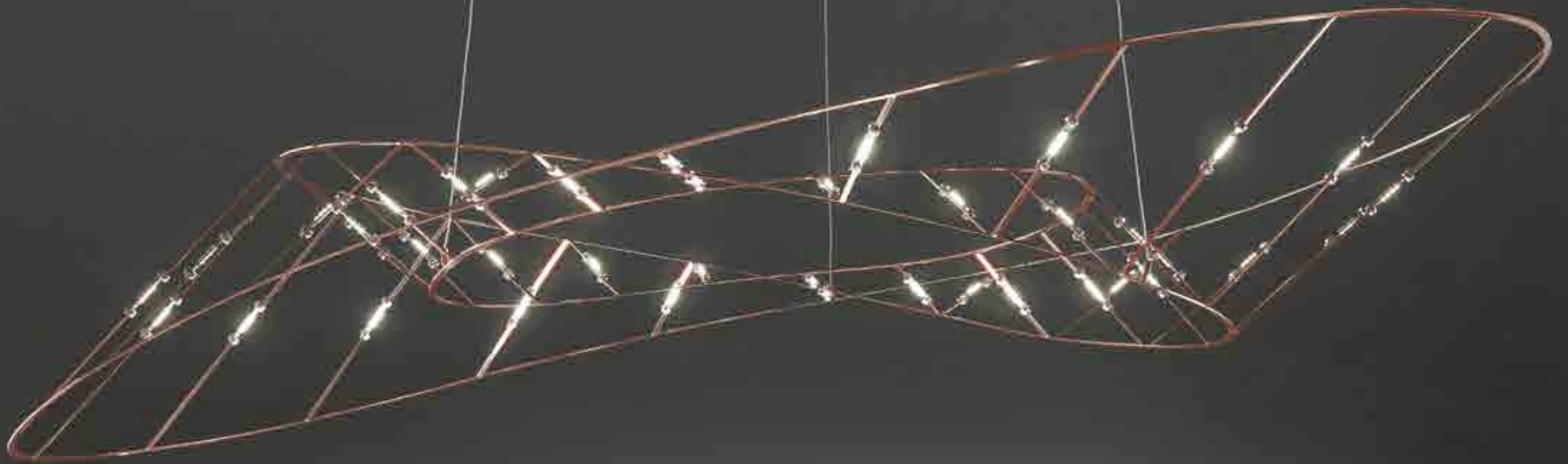

TESA SUSPENSION

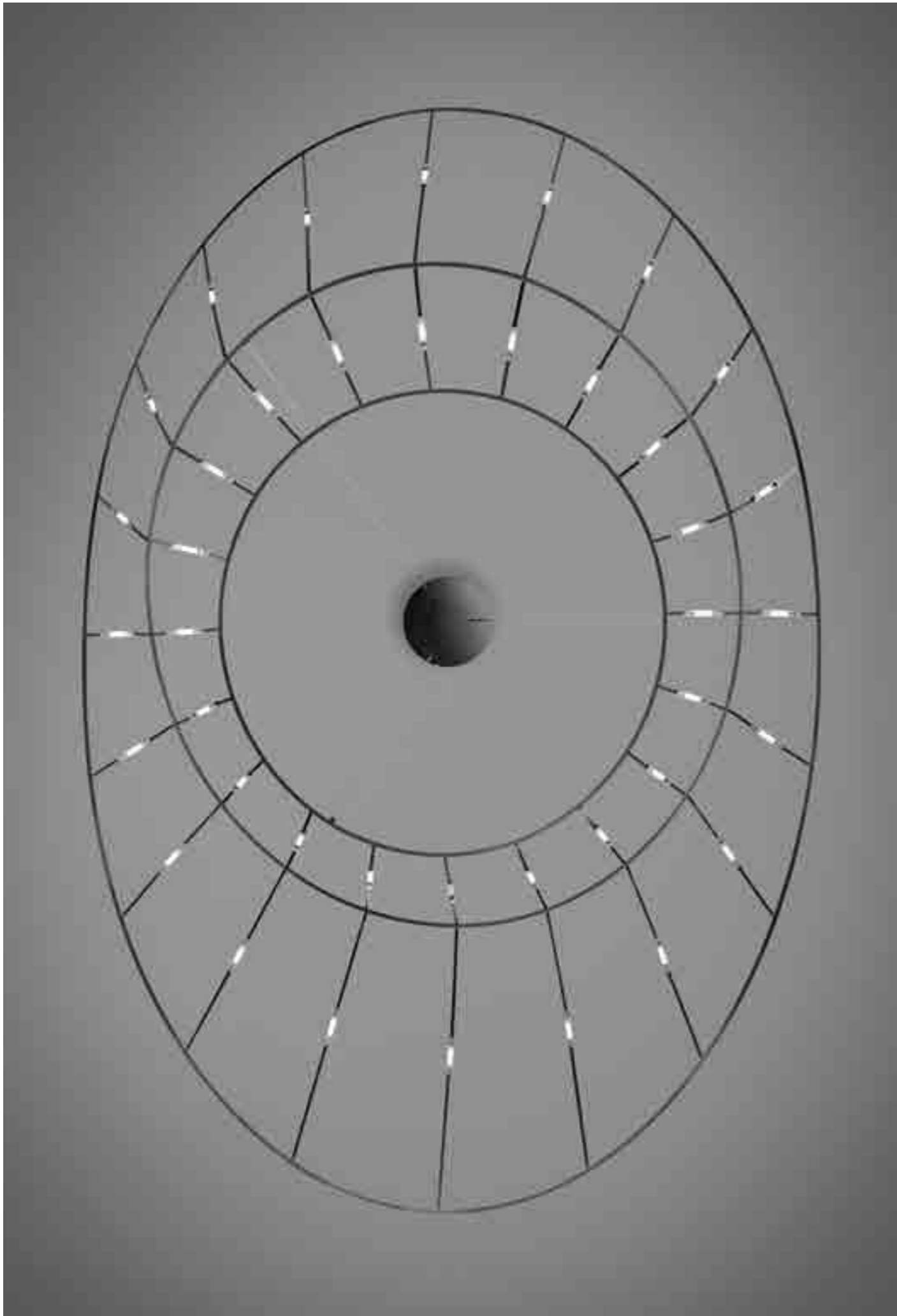

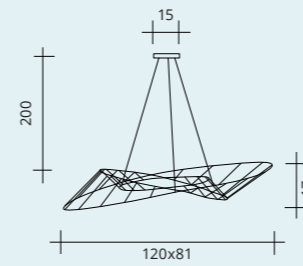

LED 40W - 24V
2700°K / 3000 lumen
3000°K / 3200 lumen

TESA Suspension

Lampada a sospensione
Pendelleuchte
Lámpara colgante
Подвесная лампа



FINISHES / FINITURE / FARBE / ACABADOS / ОТДЕЛКИ

- Chrome / Cromo / Chrom / Cromo / Хром
- Black / Nero / Schwarz / Negro / Чёрный цвет
- Copper / Rame / Kupfe / Cobre / Медь

LAFRA

design Andrea Barra

LAFRA COLLECTION

Pure elegance and stylistic innovation.

Lafra is a range of products that meet the needs of light, technology and appearance.

The metal, an electrical conductor, is available in three colours (black nickel, chrome or copper) and can be used to supply power to and turn on the 1W LED modules.

Available in 2700°K and 3000°K versions.

Dimmable and non-dimmable, optional cover.

LAFRA COLLEZIONE

Elenganza pura con innovazione stilistica. Lafra è una famiglia di prodotti che soddisfano i bisogni di luce, tecnologia ed estetica.

Il metallo, conduttore di corrente, disponibile nei colori rame, nickel nero e cromo, permette di alimentare e accendere i moduli led da 1 w. Disponibile 2700°K e 3000°K. Dimmerabile e non, coperture optional.

LAFRA COLLEZIONE

Pure Eleganz mit stilistischer Innovation. Lafra ist eine Produktfamilie, die dem Wunsch nach Licht, Technologie und Ästhetik gerecht wird.

Das stromleitende Metall ist in den Farben Kupfer, Nickel schwarz, und Chrom erhältlich und dient zum Speisen und Einschalten der 1W Led-Module. Erhältlich mit 2700°K und 3000°K. Dimmerbar und nicht dimmerbar, Abdeckungen optional.

LAFRA COLECCIÓN

Elegancia pura con innovación estilística. Lafra es una familia de productos que satisface las necesidades de luz, tecnología y aspecto estético.

El metal, conductor de corriente, disponible en los colores cobre, níquel negro y cromo, permite alimentar y encender los módulos led de 1 w. Disponible con temperaturas de color de 2700°k y 3000°k. De intensidad luminosa regulable y fija, coberturas opcionales.

КОЛЛЕКЦИЯ LAFRA

Безупречная элегантность и обновленный дизайн. Lafra – это серия изделий, которые удовлетворяют потребности, связанные с освещением, технологиями и эстетикой. Токпроводящий металл цвета черного никеля, хрома или меди позволяет питать и включать светодиодные модули 1 Вт.

Имеются в наличии модели 2700°K и 3000°K. С диммером и без, крышки не входят в базовую комплектацию

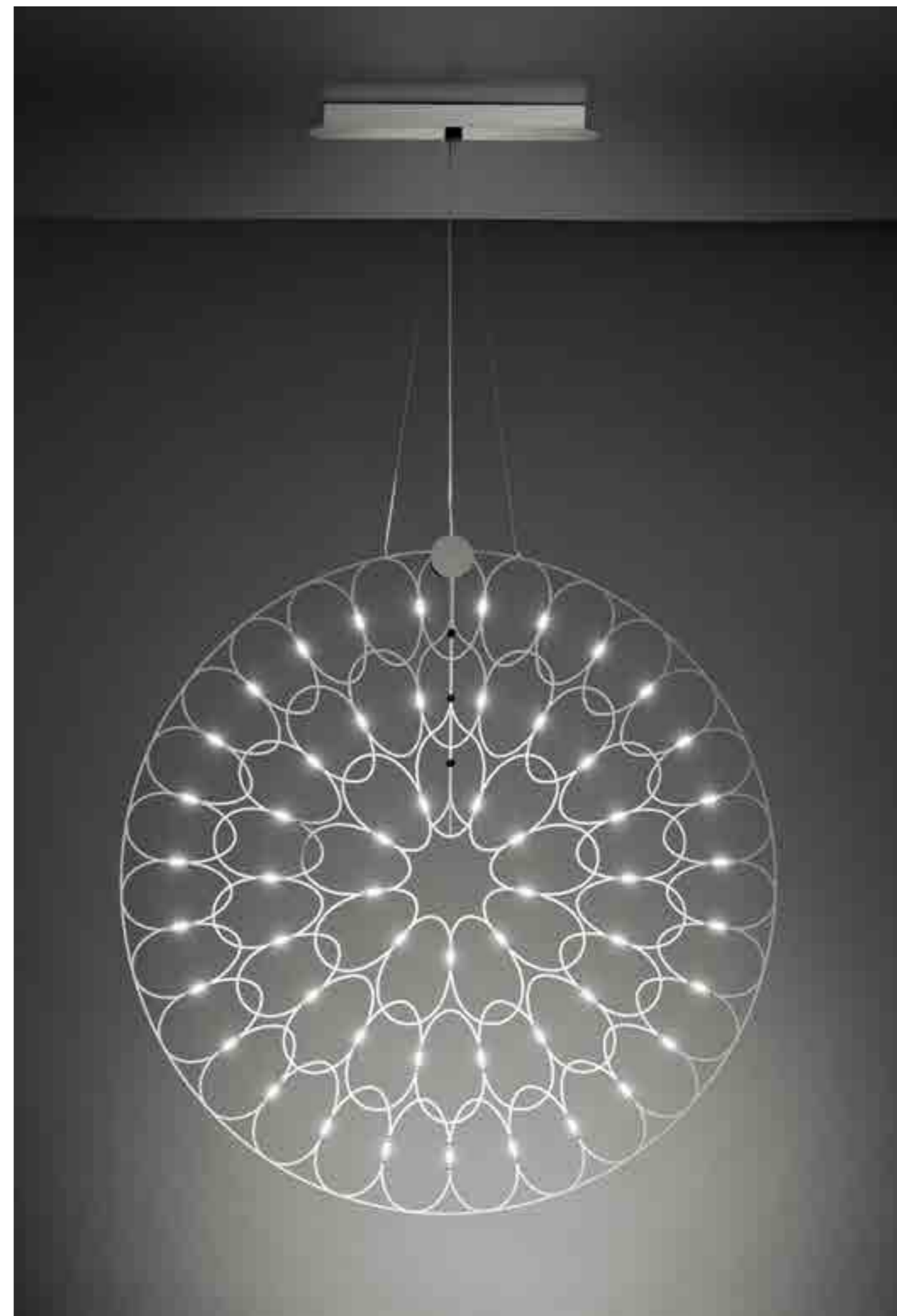

LAFRA VERTICAL SUSPENSION

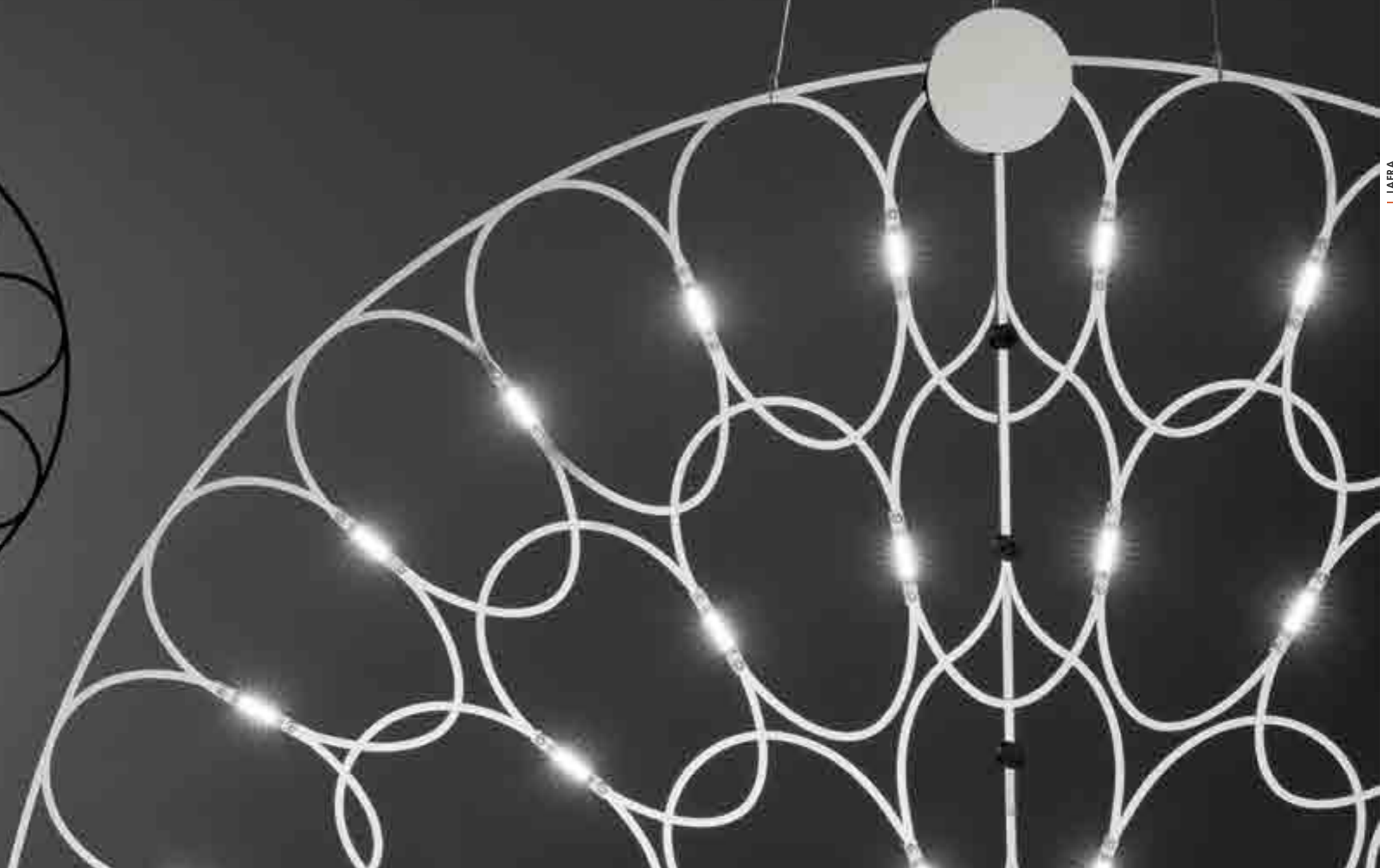

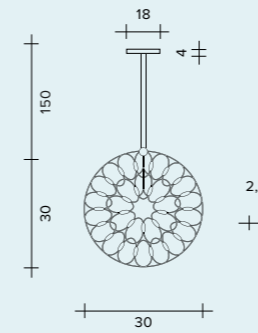

LED 7W - 24V
2700°K / 525 lumen
3000°K / 560 lumen

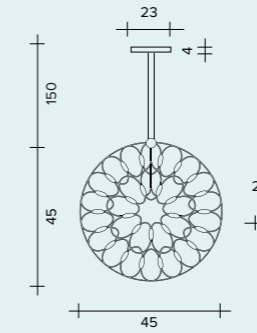

LED 9W - 24V
2700°K / 675 lumen
3000°K / 720 lumen

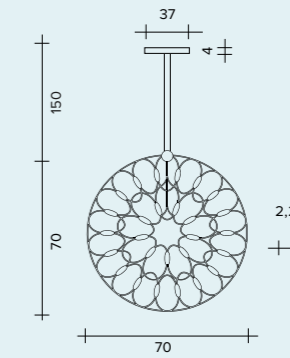

LED 27W - 24V
2700°K / 2025 lumen
3000°K / 2160 lumen

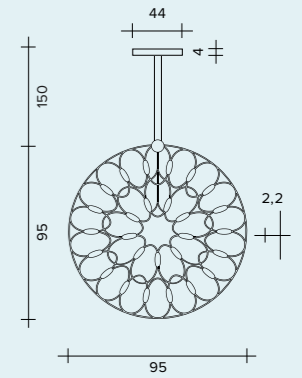

LED 54W - 24V
2700°K / 4050 lumen
3000°K / 4320 lumen

LAFRA

Vertical suspension

Lampada a sospensione verticale

Vertikale pendelleuchte

Lámpara colgante vertical

Подвесная лампа вертикального типа



FINISHES / FINITURE / FARBE / ACABADOS / ОТДЕЛКИ

- Black / Nero / Schwarz / Negro / Чёрный цвет
- Chrome / Cromo / Chrom / Cromo / Хром
- Copper / Rame / Kupfe / Cobre / Медь

LAFRA HORIZONTAL SUSPENSION

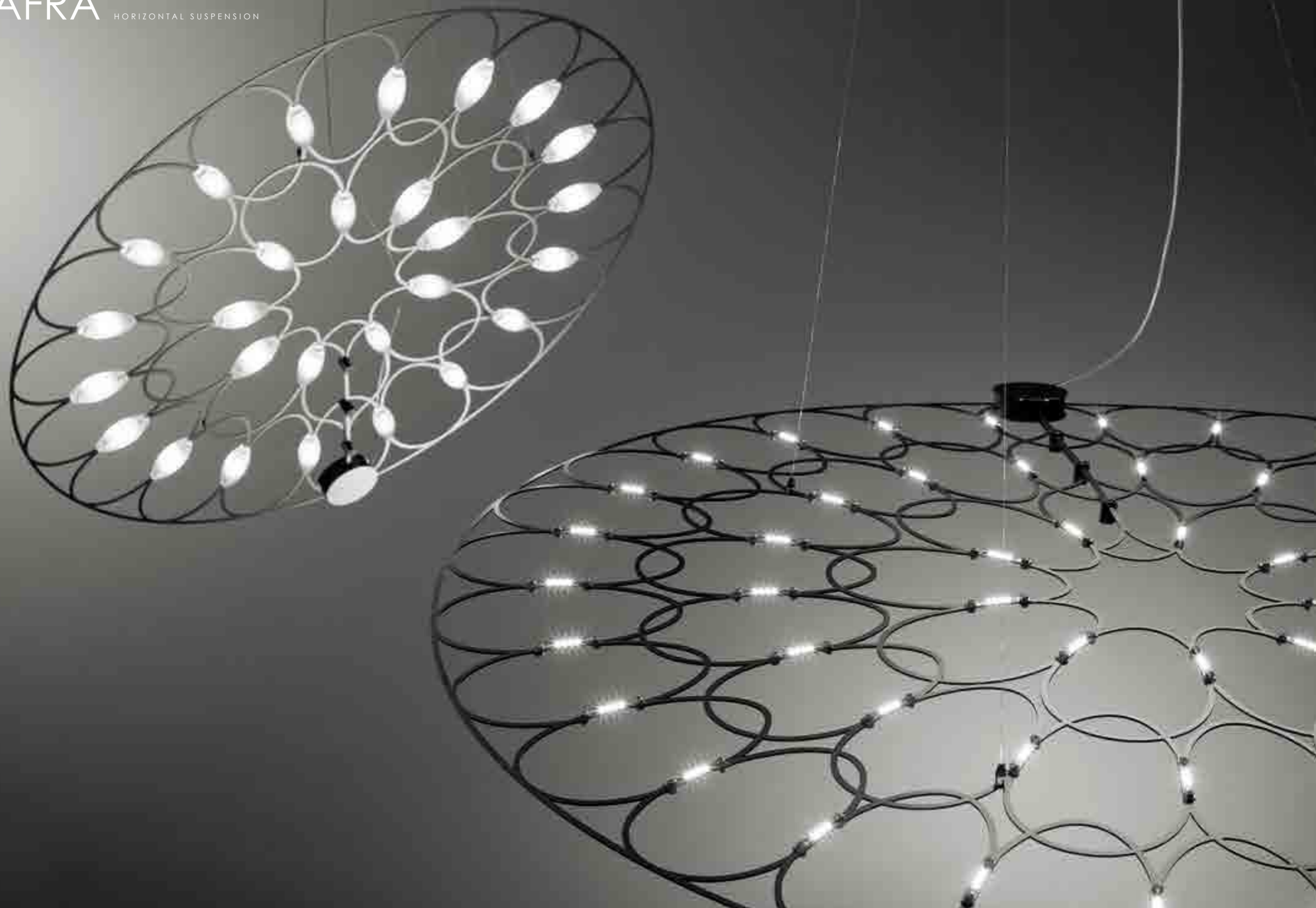

LAFRA

HORIZONTAL SUSPENSION



LAFRA

HORIZONTAL SUSPENSION

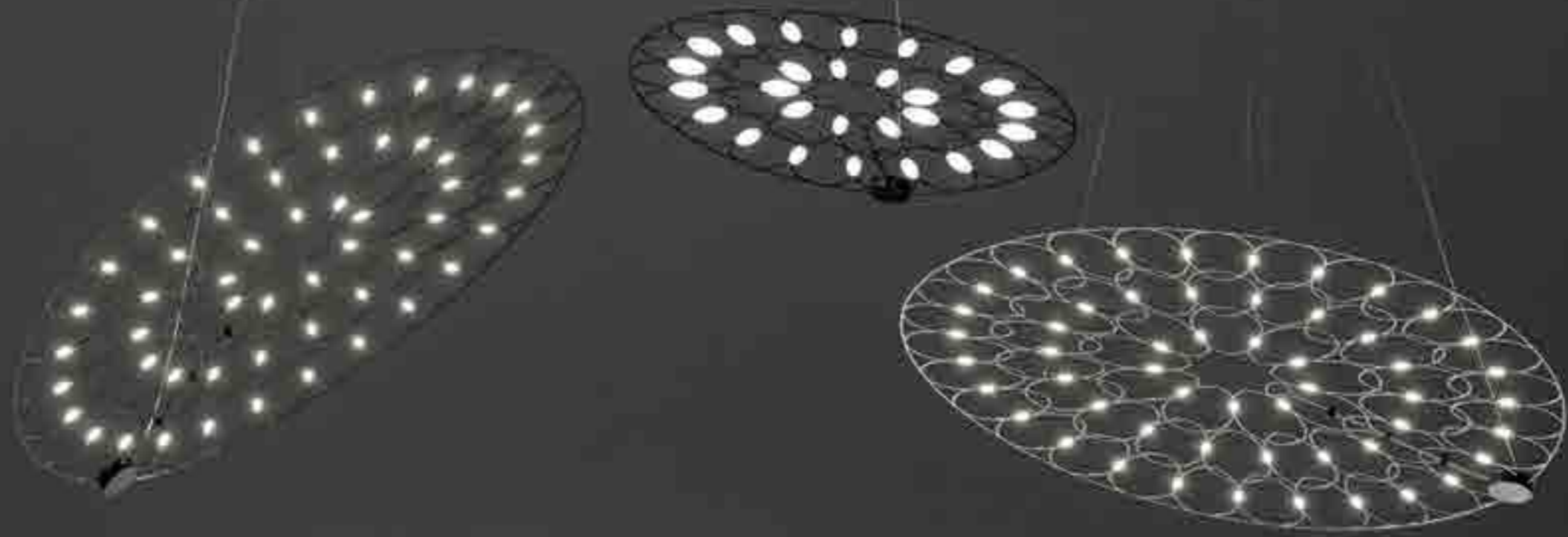

LAFRA

HORIZONTAL SUSPENSION

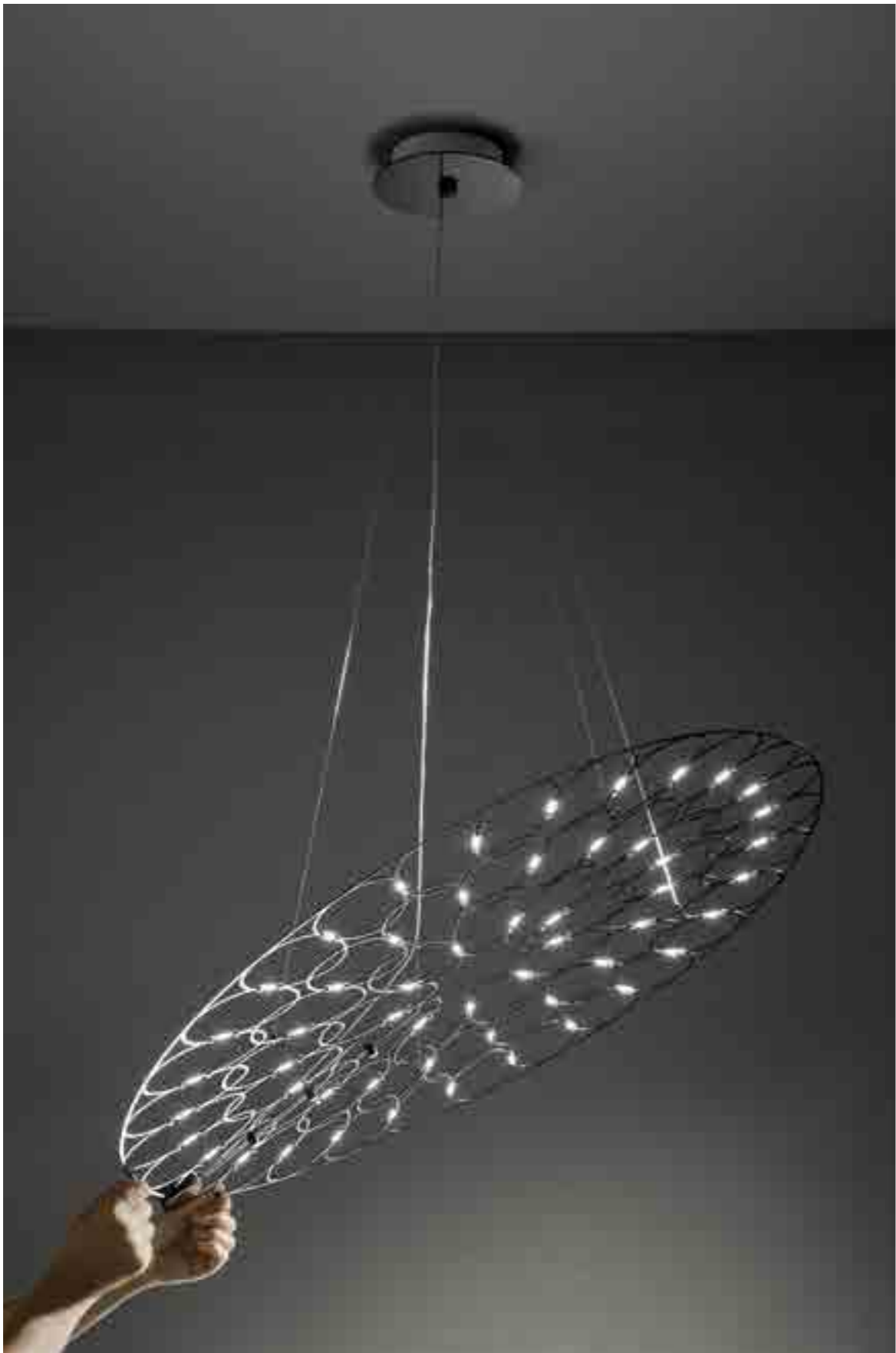

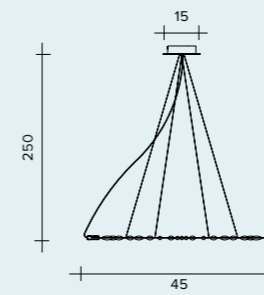
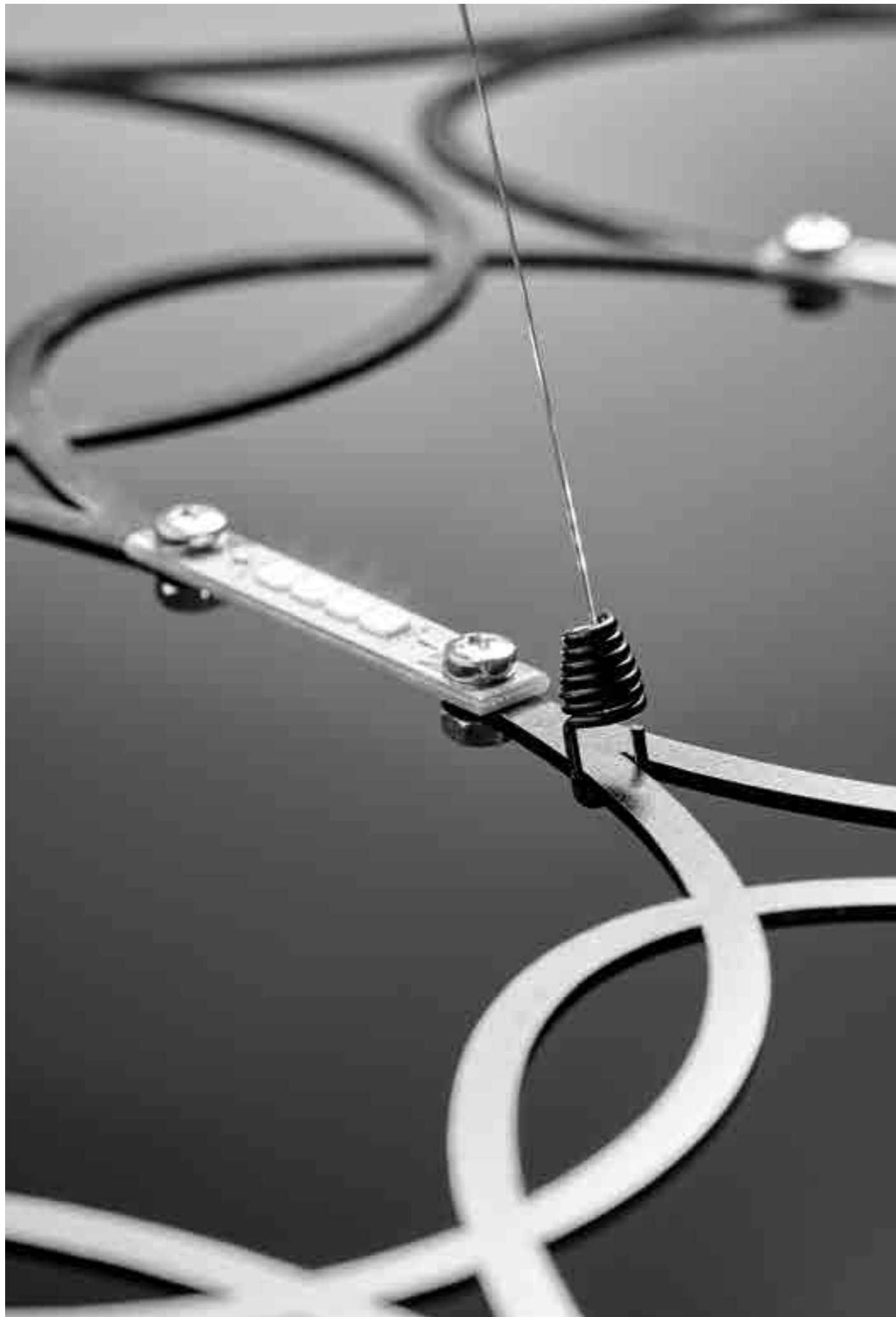

LED 9W - 24V
2700°K / 675 lumen
3000°K / 720 lumen

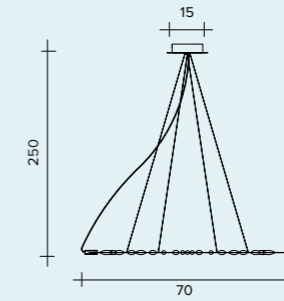

LED 27W - 24V
2700°K / 2052 lumen
3000°K / 2160 lumen

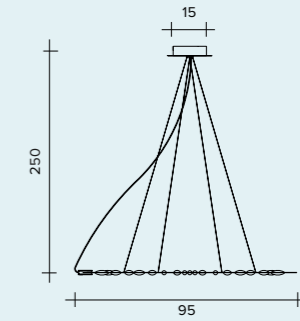

LED 54W - 24V
2700°K / 4050 lumen
3000°K / 4320 lumen

LAFRA

Horizontal suspension

Lampada a sospensione orizzontale

Horizontale pendelleuchte

Lámpara colgante horizontal

Подвесная лампа горизонтального типа



FINISHES / FINITURE / FARBE / ACABADOS / ОТДЕЛКИ

- Black / Nero / Schwarz / Negro / Чёрный цвет
- Chrome / Cromo / Chrom / Cromo / Хром
- Copper / Rame / Kupfe / Cobre / Медь

LAFRA CEILING





LAFRA CEILING



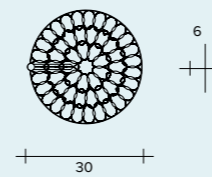
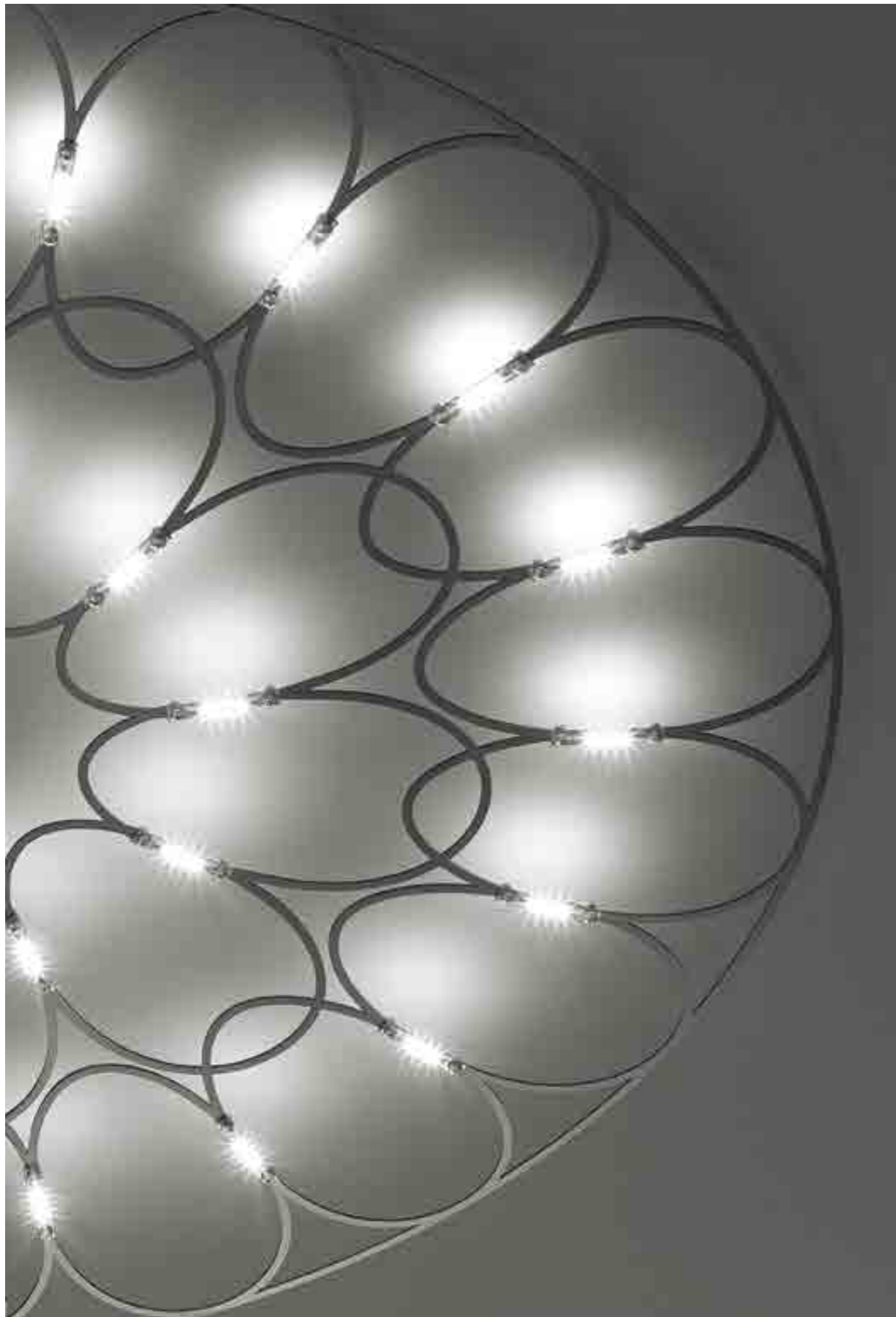

LED 7W - 24V
2700°K / 525 lumen
3000°K / 560 lumen

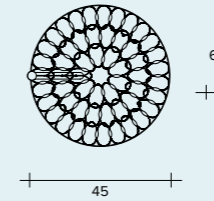

LED 9W - 24V
2700°K / 675 lumen
3000°K / 720 lumen

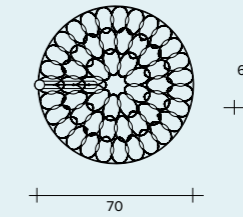

LED 27W - 24V
2700°K / 2052 lumen
3000°K / 2160 lumen

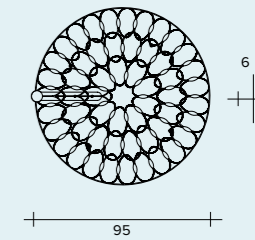

LED 54W - 24V
2700°K / 4050 lumen
3000°K / 4320 lumen

LAFRA Ceiling

Lampada da soffitto
Deckenleuchte
Lámpara de techo
Потолочная лампа



FINISHES / FINITURE / FARBE / ACABADOS / ОТДЕЛКИ

- Black / Nero / Schwarz / Negro / Чёрный цвет
- Chrome / Cromo / Chrom / Cromo / Хром
- Copper / Rame / Kupfe / Cobre / Медь

LAFRA WALL

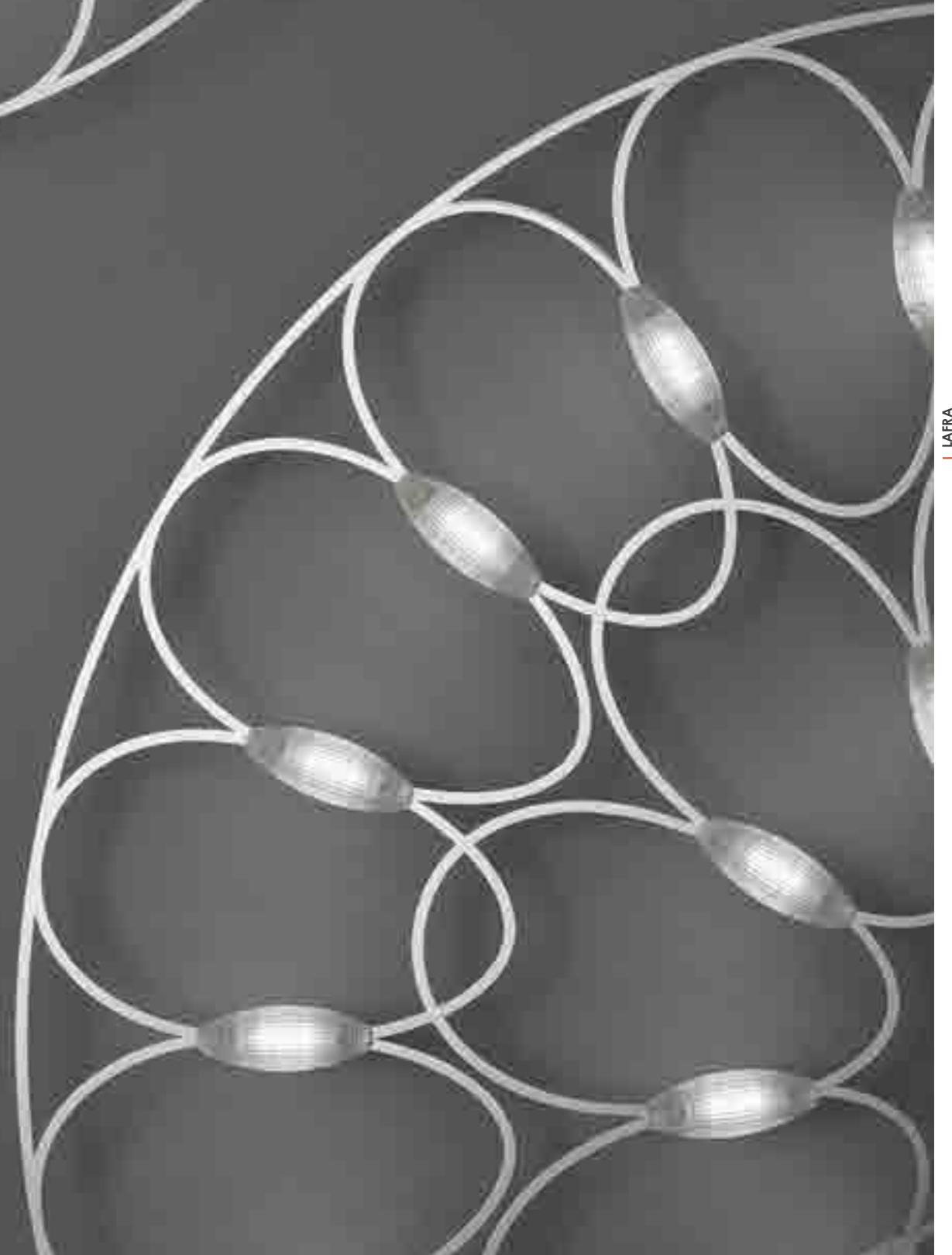
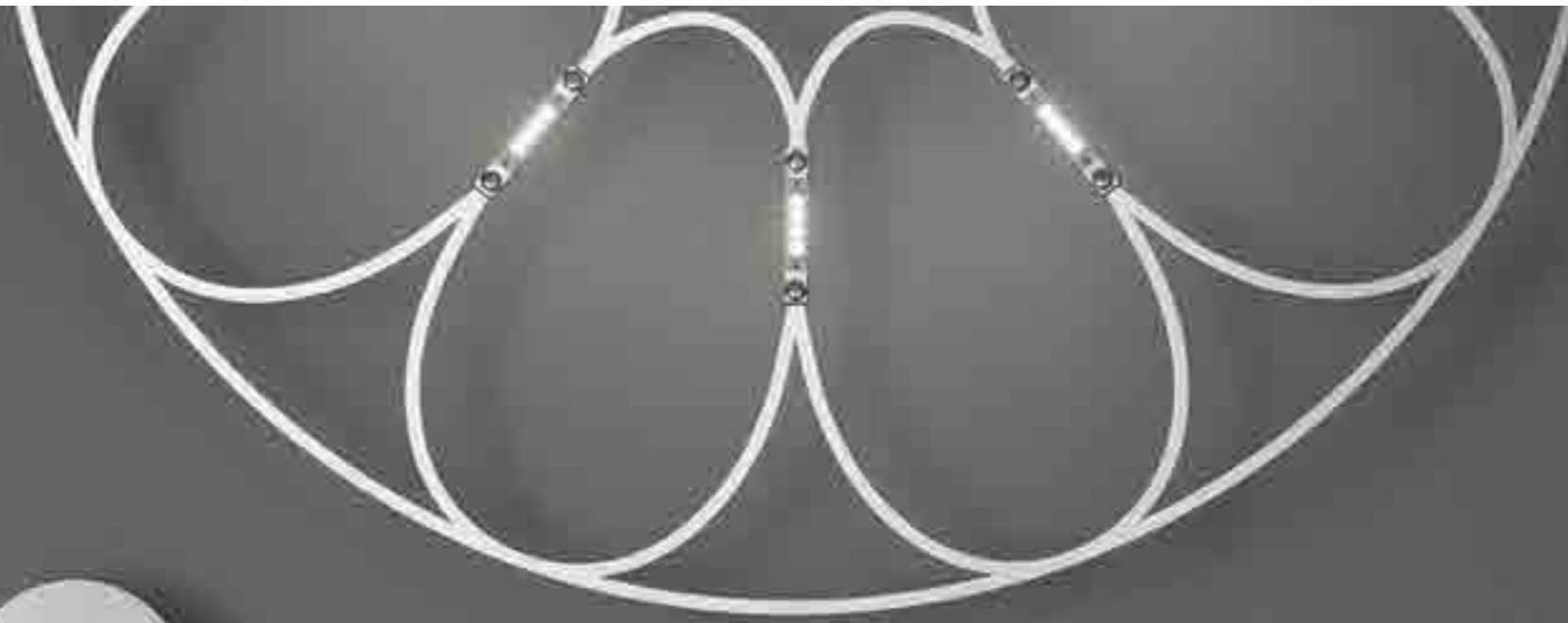
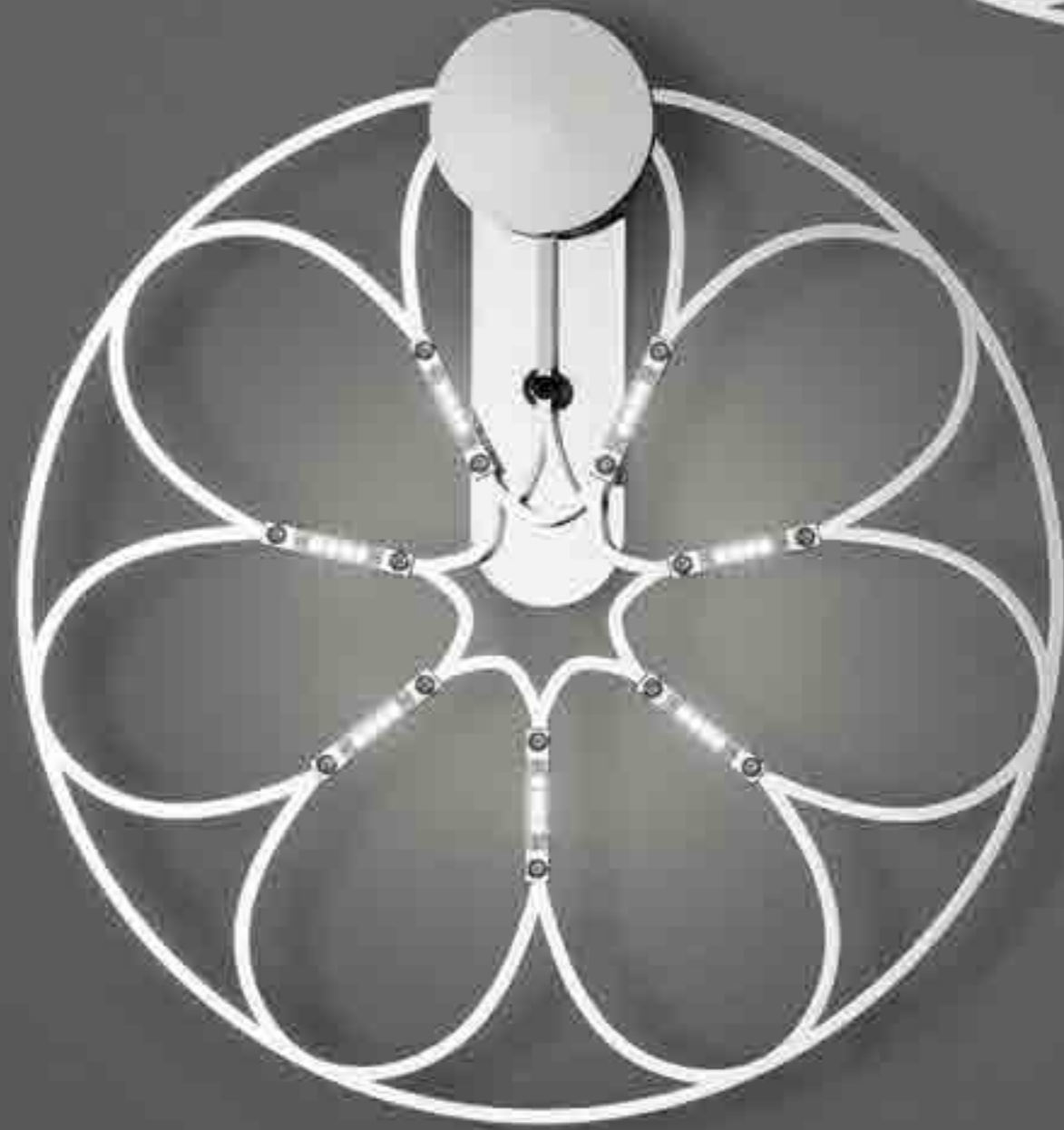

LAFRA

LAFRA WALL



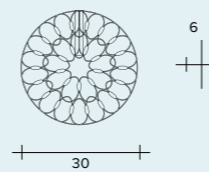

LED 7W - 24V
2700°K / 525 lumen
3000°K / 560 lumen

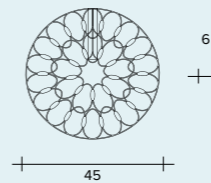

LED 9W - 24V
2700°K / 675 lumen
3000°K / 720 lumen

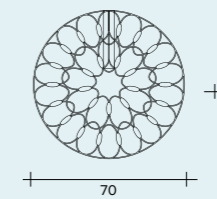

LED 27W - 24V
2700°K / 2052 lumen
3000°K / 2160 lumen

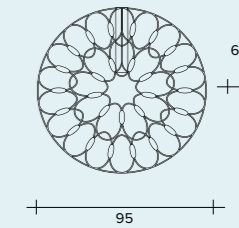

LED 54W - 24V
2700°K / 4050 lumen
3000°K / 4320 lumen

LAFRA Wall

Lampada da parete
Wandleuchte
Lámpara de pared
Настенная лампа



FINISHES / FINITURE / FARBE / ACABADOS / ОТДЕЛКИ

- Black / Nero / Schwarz / Negro / Чёрный цвет
- Chrome / Cromo / Chrom / Cromo / Хром
- Copper / Rame / Kupfer / Cobre / Медь

CAOS CONTRACT

design Studio O.I.L.

CAOS CONTRACT COLLECTION

Poetic lines and clean curves create light and harmonious lamps with a black and gold finish and dimmable LEDs controlled by a phase cut dimmer switch. The 220V module supplies power to the lamps to meet every need with regard to appearance and function.



reddot award 2018
honourable mention

CAOS CONTRACT COLLEZIONE

Linea poetica, curve pulite disegnano lampade leggere ed armoniose in colore nero e oro, i led sono dimmerabili con dimmer a taglio di fase. Con il modulo a 220v si ha la possibilità di alimentare le lampade per ogni esigenza: estetica e funzionale.

CAOS CONTRACT KOLLEKTION

Poetische Linie und saubere Kurven, die leichten und harmonischen Leuchten sind in Schwarz und goldfarben erhältlich; LED mit Phasenabschnittsdimmer dimmerbar. Mit dem 220V Modul kann man die Leuchten für jeden Bedarf speisen: ästhetisch und praktisch.

CAOS CONTRACT COLECCIÓN

Línea poética y curvas limpias diseñan lámparas ligeras y armoniosas, en color negro y oro, la intensidad luminosa de los ledes es regulable con regulador de corte de fase. Con el módulo de 220 V es posible alimentar las lámparas para cada exigencia: estética y funcional.

КОЛЛЕКЦИЯ CAOS CONTRACT

Поэтичная линия, аккуратные изгибы отличают дизайн легких и гармоничных ламп черного и золотого цвета; регулировка силы света светодиодов выполняется диммером с отсечкой фазы. Модуль 220В дает возможность питать лампы в зависимости от любых эстетических или функциональных потребностей.





CAOS CONTRACT

CEILING

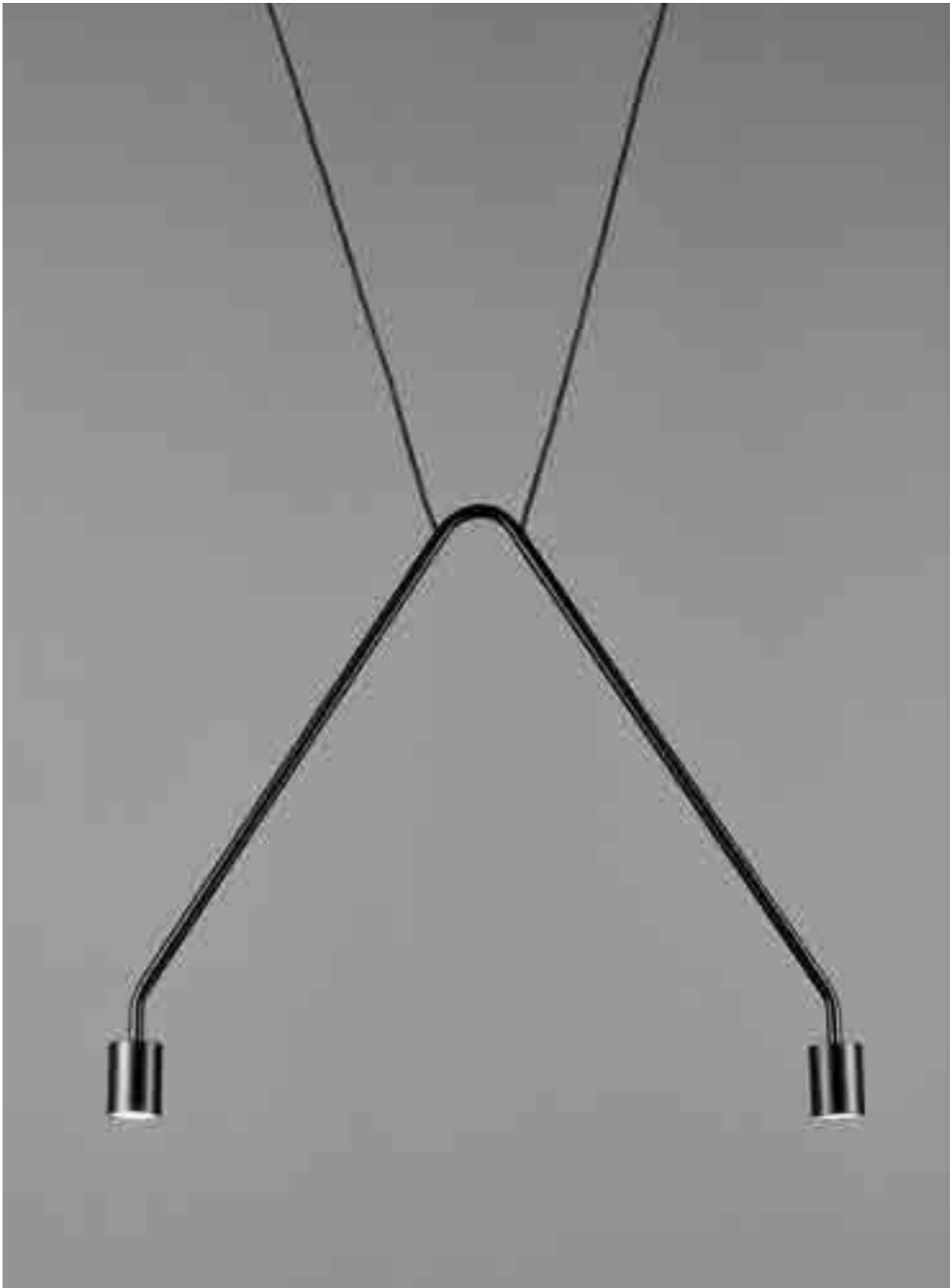

CAOS CONTRACT

CEILING

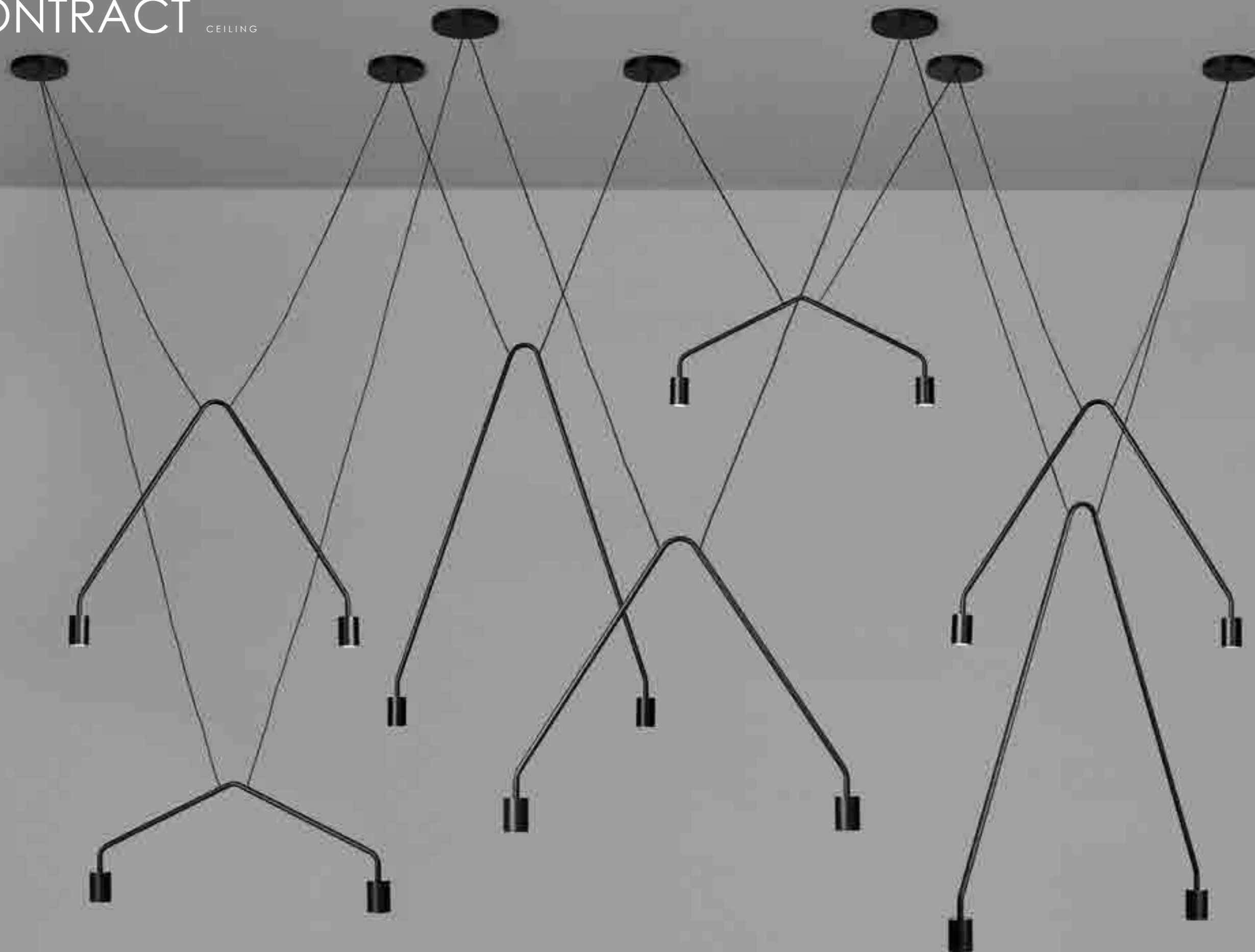

CAOS CONTRACT

CEILING

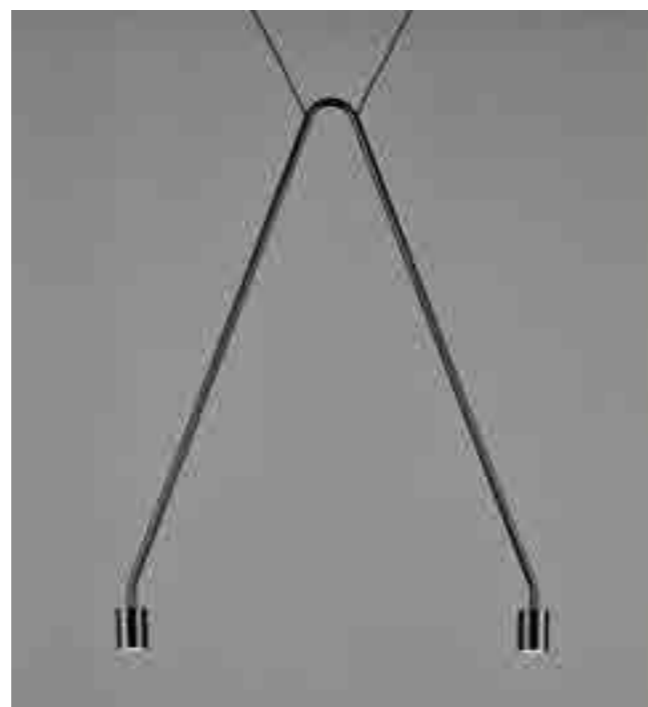

CAOS CONTRACT

SUSPENSION
GOLD EDITION



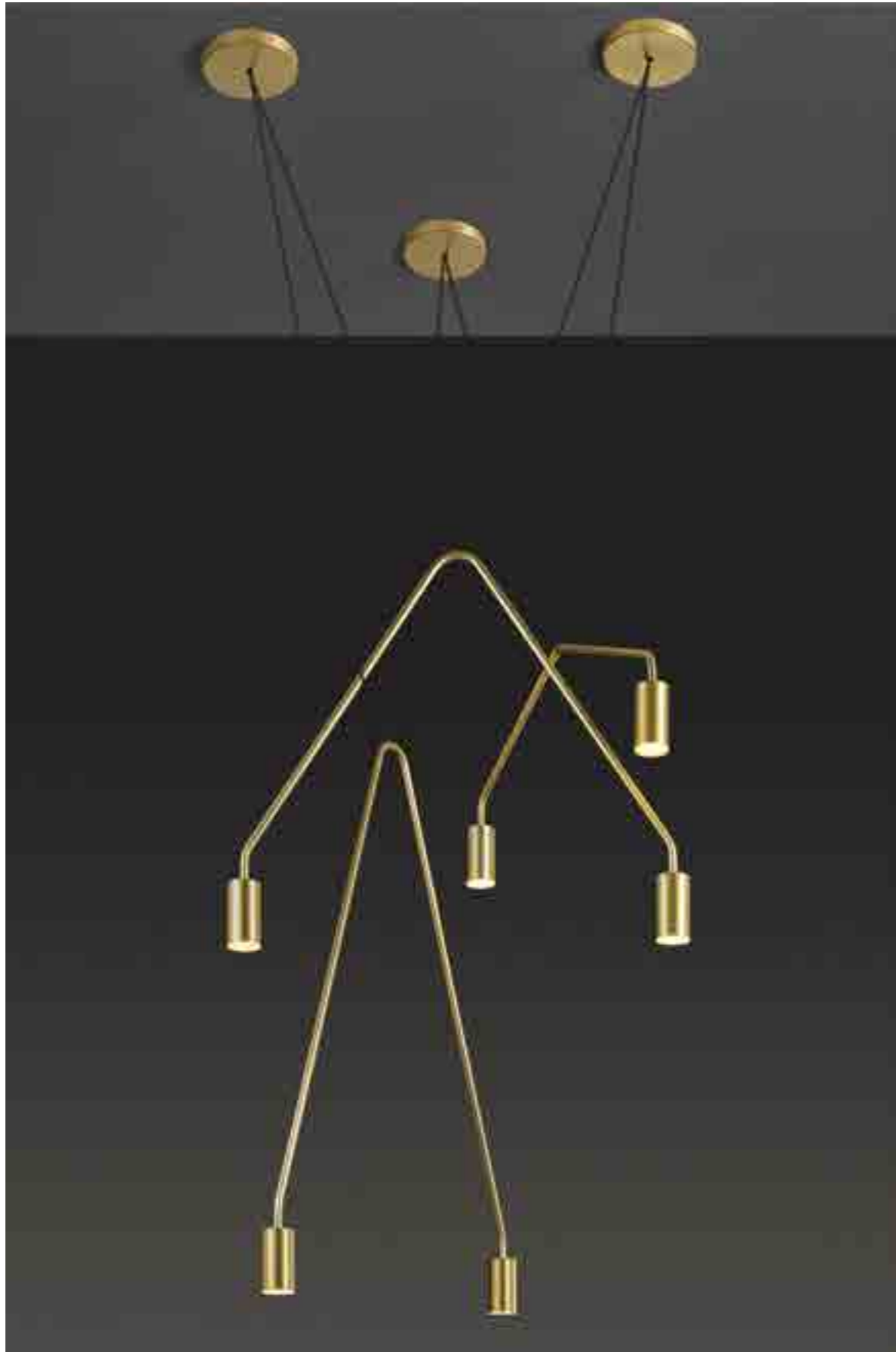

CAOS CONTRACT

SUSPENSION
GOLD EDITION



CAOS CONTRACT

SUSPENSION
GOLD EDITION

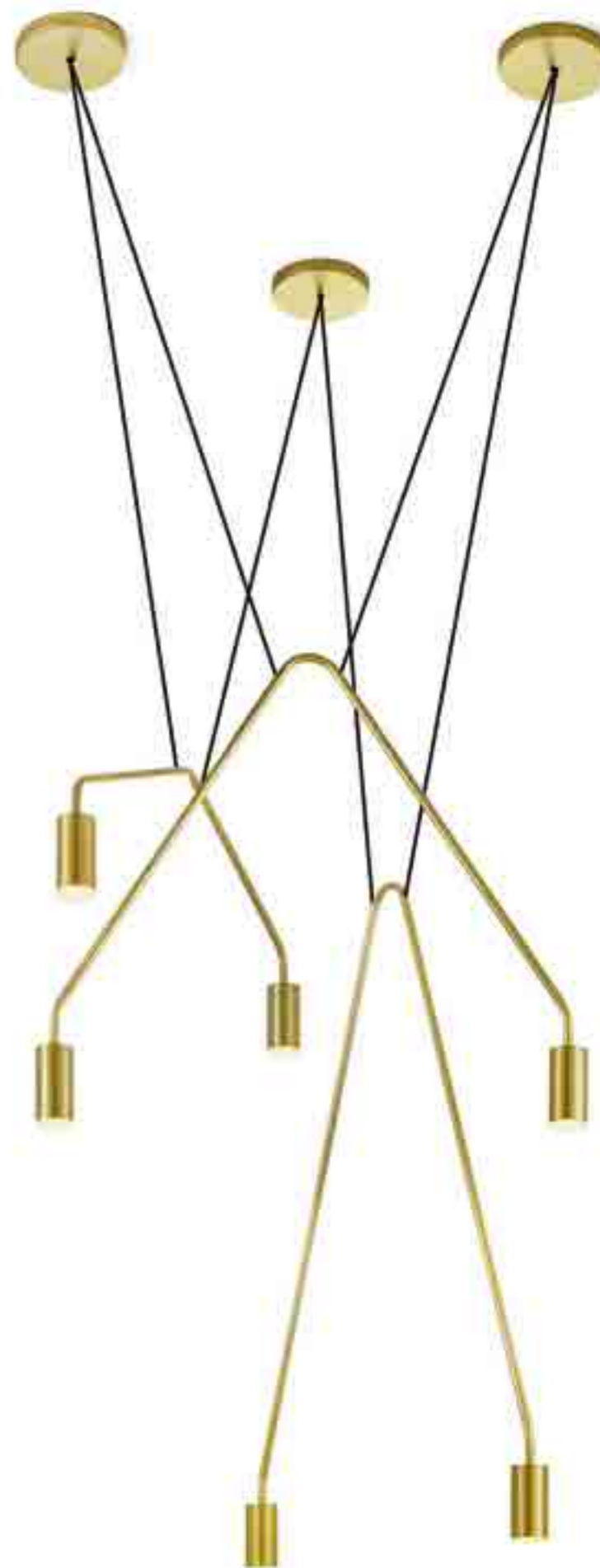
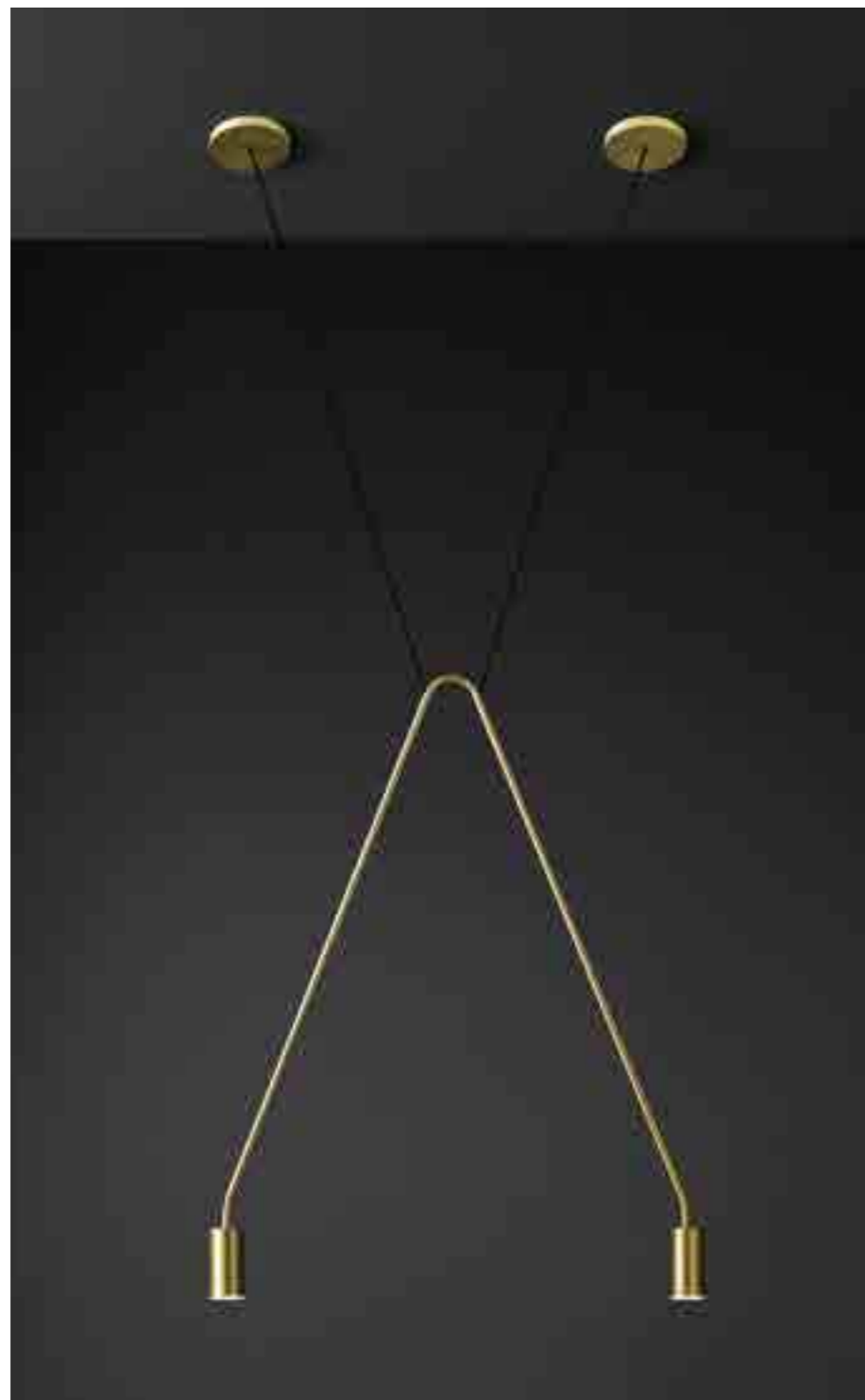

CAOS CONTRACT

MODULAR SYSTEM

This modular system is available in three sizes: small, medium, large. The system can be connected to the power supply from any rosette. The drawings illustrate installation examples.

Il sistema è componibile nelle tre dimensioni: piccola, media, grande. Partendo da qualsiasi rosette il sistema viene elettrificato. Nei disegni sono indicati degli esempi di installazione.

Das System ist in den drei Größen zusammenstellbar: klein, mittelgroß, groß. Das System wird von einer beliebigen Rosette ausgehend elektrifiziert. In den Zeichnungen sind Installationsbeispiele aufgeführt.

El sistema es componible en las tres dimensiones: pequeña, mediana, grande. Partiendo de cualquier rosetón se electrifica el sistema. En los dibujos se presentan unos ejemplos de instalación.

Систему можно выполнять в трех вариантах по размерам: маленький размер, средний размер, большой размер. Система электрифицируется, независимо от вида диска. На рисунках приведены примеры монтажа.

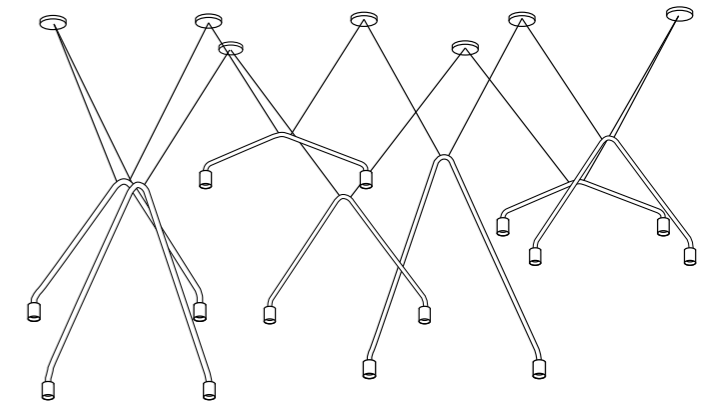
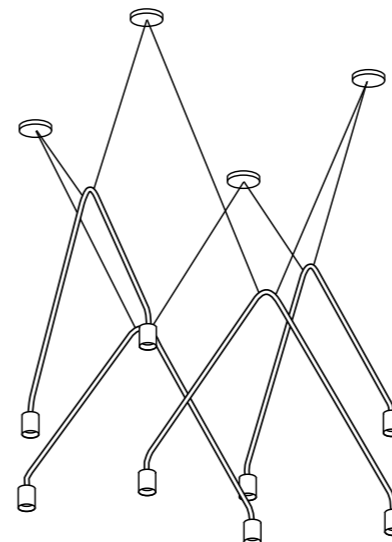
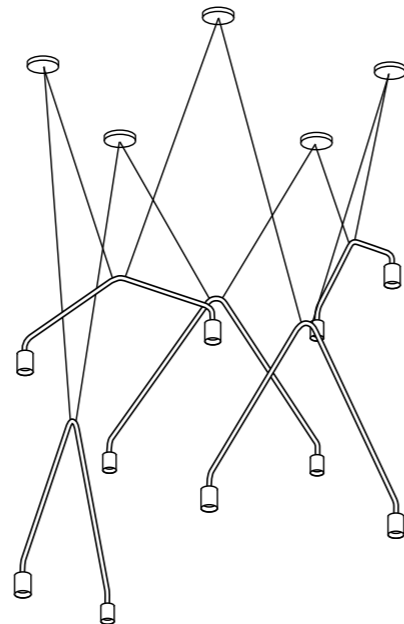
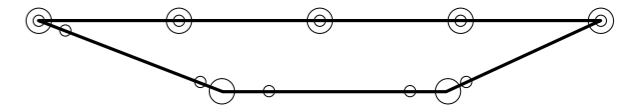
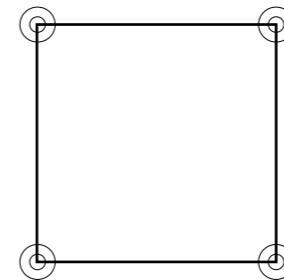
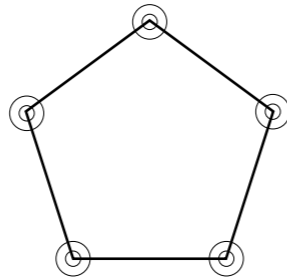
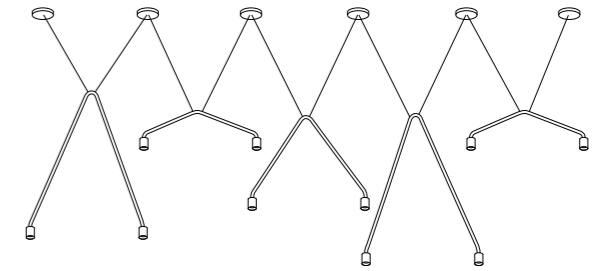
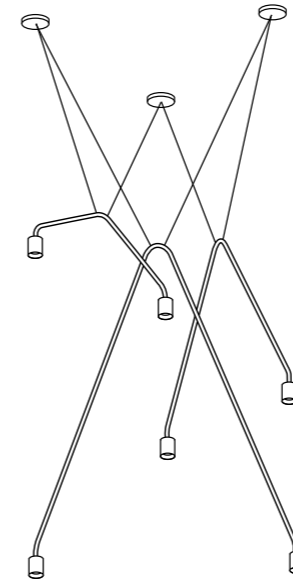
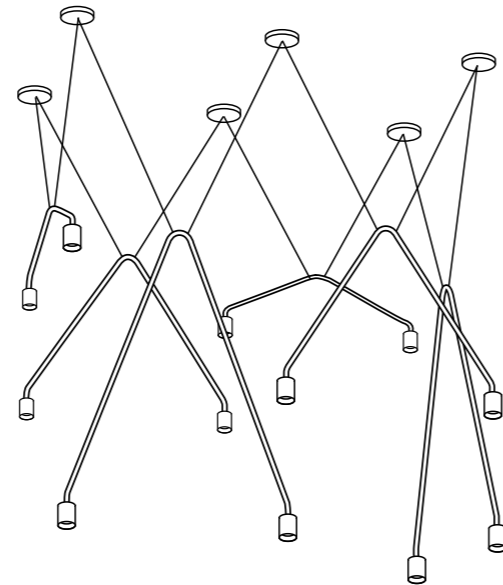
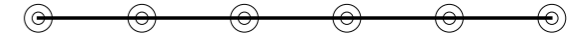
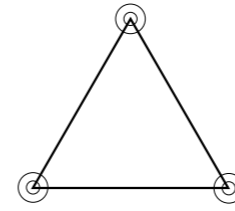
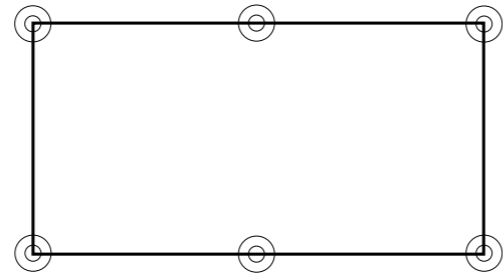

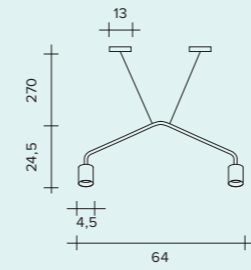

2 x G9 LED max 6w

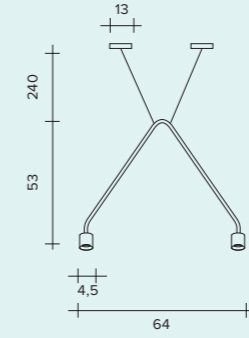

2 x G9 LED max 6w

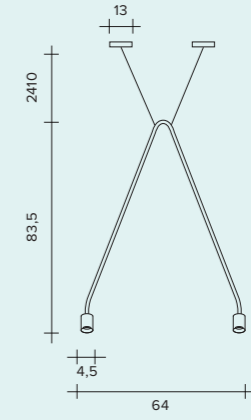

2 x G9 LED max 6w

CAOS CONTRACT Ceiling

Lampada da soffitto
Deckenleuchte
Lámpara de techo
Потолочная лампа



FINISHES / FINITURE / FARBE / ACABADOS / ОТДЕЛКИ

- Black / Nero / Schwarz / Negro / Чёрный цвет
- Brushed gold / Oro spazzolato / Gold gebürstet
Oro cepillado / Брашированное золото

CAOS

design Studio O.I.L.

CAOS COLLECTION

Poetic lines and clean curves create light and harmonious lamps with a black and gold finish and dimmable LEDS controlled by a phase cut dimmer switch.



reddot award 2018
honourable mention

CAOS COLLEZIONE

*Linea poetica, curve pulite
disegnano lampade leggere
ed armoniose in colore nero e oro,
i led sono dimmerabili con dimmer
a taglio di fase.*

CAOS KOLLEKTION

*Poetische Linie und saubere Kurven,
die leichten und harmonischen
Leuchten sind in Schwarz und
goldfarben erhältlich; LED mit
Phasenabschnittsdimmer
dimmerbar.*

CAOS COLECCIÓN

*Línea poética y curvas limpias
diseñan lámparas ligeras y
armoniosas, en color negro y oro,
la intensidad luminosa de
los ledes es regulable con
regulador de corte de fase.*

КОЛЛЕКЦИЯ CAOS

*Поэтичная линия, аккуратные
изгибы отличают дизайн легких
и гармоничных ламп черного и
золотого цвета; регулировка
света светодиодов выполняется
диммером с отсечкой фазы.*



CAOS SUSPENSION



CAOS SUSPENSION
GOLD EDITION

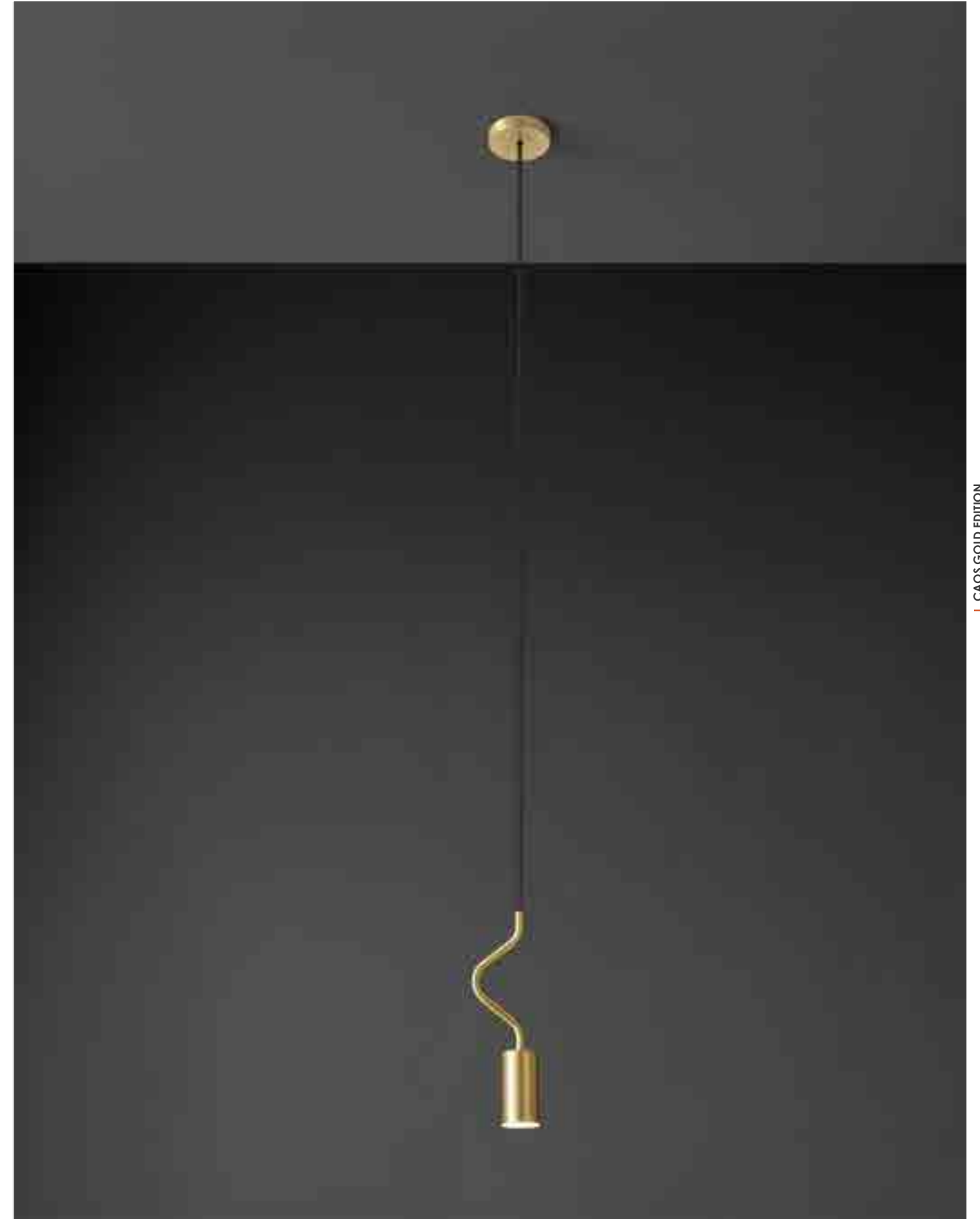
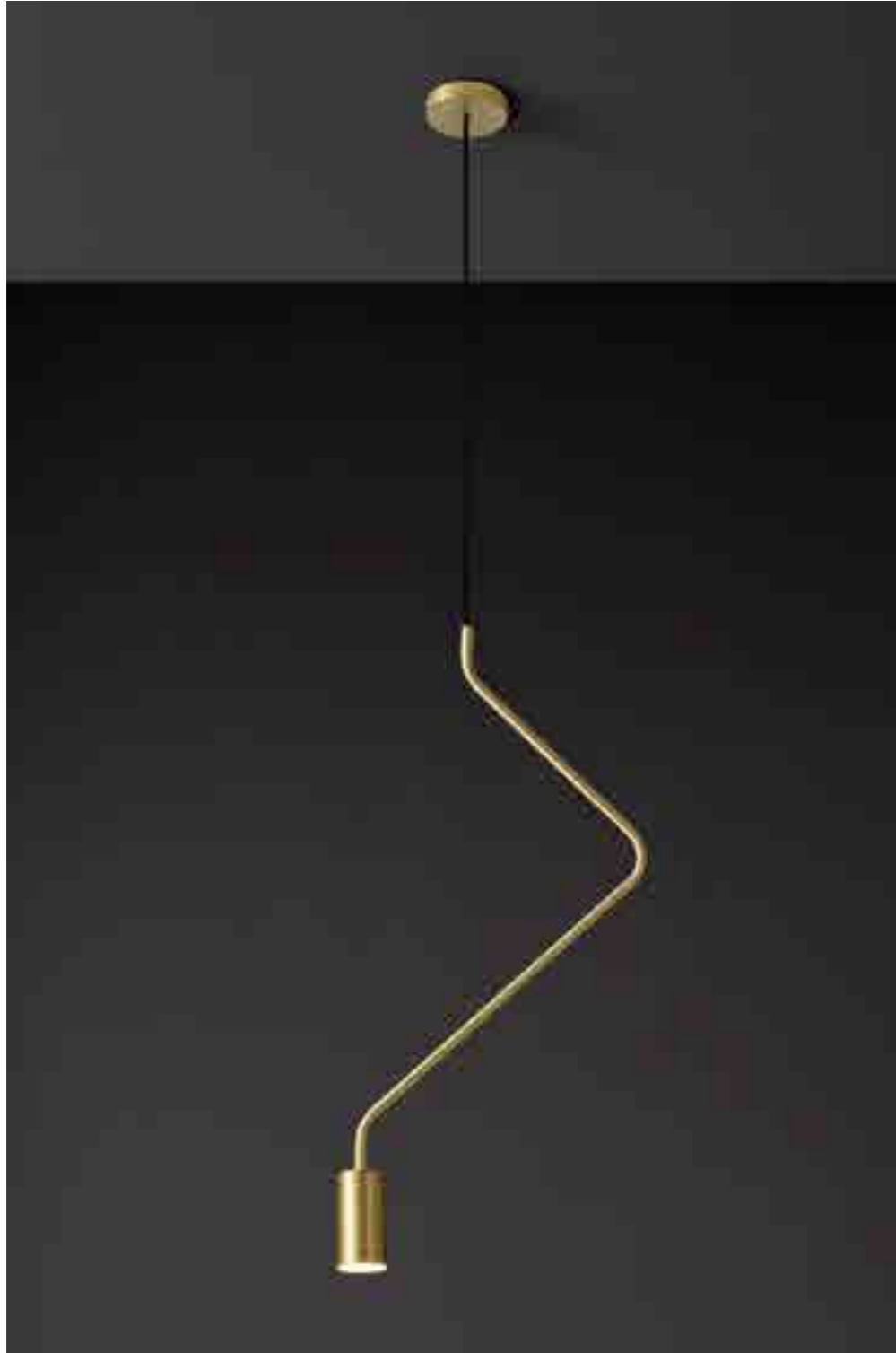

| CAOS GOLD EDITION



CAOS SUSPENSION
GOLD EDITION

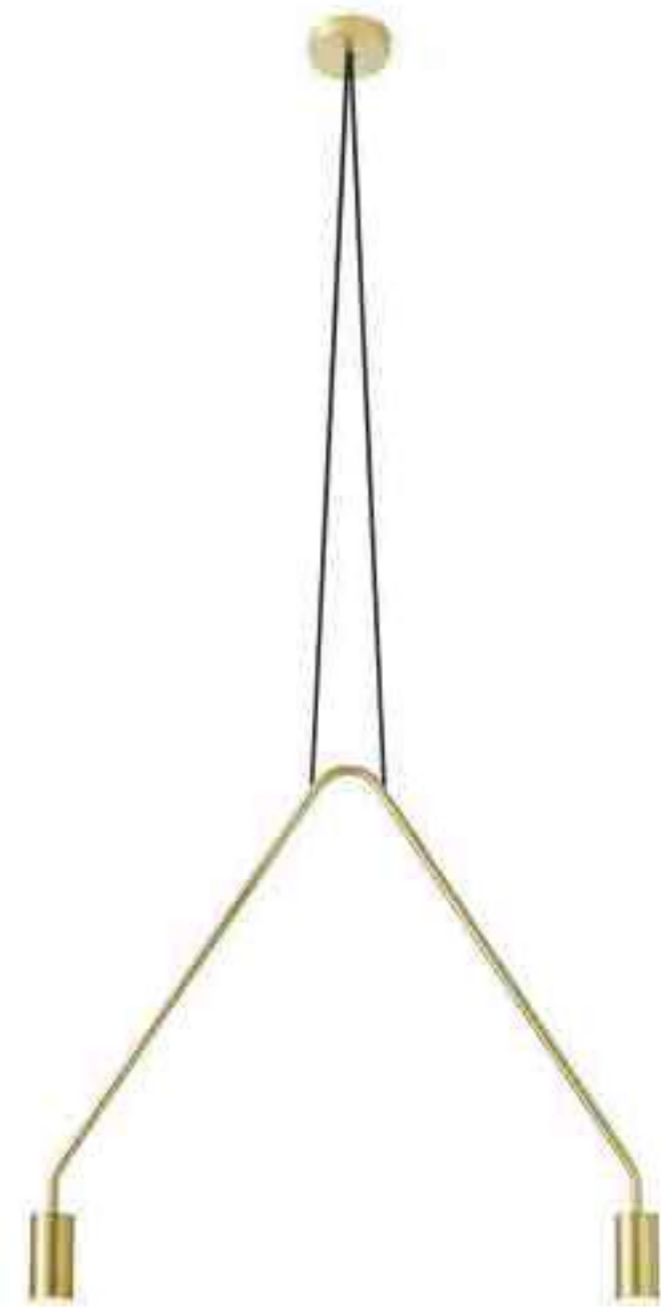

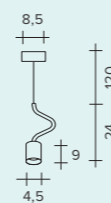

1 x G9 LED max 6w

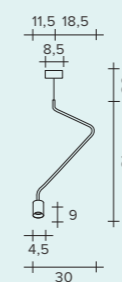

1 x G9 LED max 6w

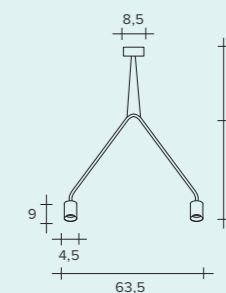

2 x G9 LED max 6w

CAOS Suspension

Lampada a sospensione
Pendelleuchte
Lámpara colgante
Подвесная лампа



FINISHES / FINITURE / FARBE / ACABADOS / ОТДЕЛКИ

- Black / Nero / Schwarz / Negro / Чёрный цвет
- Brushed gold / Oro spazzolato / Gold gebürstet
Oro serillado / Брашированное золото



CAOS CEILING
GOLD EDITION



CAOS CEILING



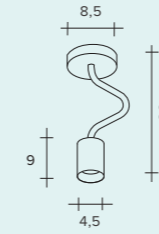
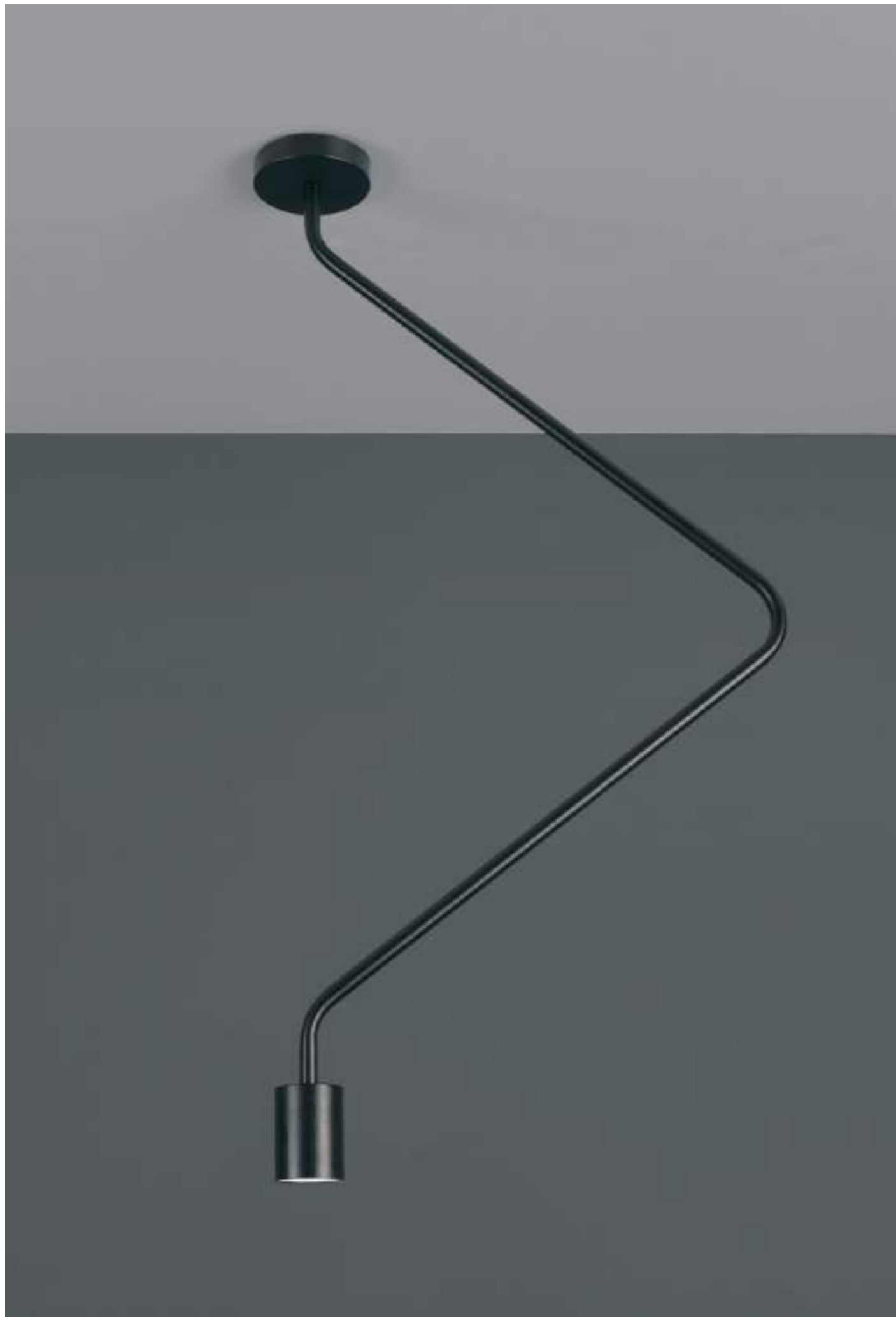

1 x G9 LED max 6w

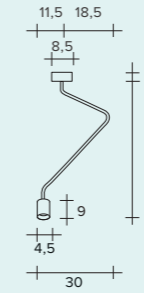

1 x G9 LED max 6w

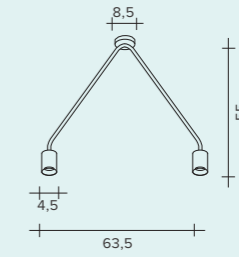

2 x G9 LED max 6w

CAOS Ceiling

Lampada da soffitto
Deckenleuchte
Lámpara de techo
Потолочная лампа



FINISHES / FINITURE / FARBE / ACABADOS / ОТДЕЛКИ

- Black / Nero / Schwarz / Negro / Чёрный цвет
- Brushed gold / Oro spazzolato / Gold gebürstet
Oro cepillado / Брашированное золото

AREA

design Marco Spatti

AREA COLLECTION

Clean lines, simple geometric forms. Area is the ultimate expression of elegance and linearity. Available in matt black or aluminium colours. A frosted shade and 3000°K LED strip create a comfortable and warm environment.

AREA COLLEZIONE

Linee pulite, geometriche essenziali. Area è la massima espressione di eleganza e linearità. In colore nero opaco ed alluminio. Copertura satinata e striscia a led di 3000°K rendono l'ambiente confortevole e caldo.

AREA KOLLEKTION

Saubere, geometrische, essentielle Linien. Area ist Ausdruck maximaler Eleganz und Linearität. In den Farben Mattschwarz und Aluminium. Die seidenmatte Abdeckung und der Led-Streifen zu 3000°K sorgen im Ambiente für komfortables und warmes Licht.

AREA COLECCIÓN

Líneas limpias, geométricas, esenciales. Area es la máxima expresión de elegancia y linealidad. En color negro mate y aluminio. Cobertura satinada y tira de ledes con temperatura de color de 3000°K hacen cálido y acogedor el ambiente.

КОЛЛЕКЦИЯ AREA

Лаконичные, геометрически четкие линии. Area – это высшее проявление элегантности и выразительности линий. Матового черного и алюминиевого цвета. Матированное покрытие и светодиодная лента 3000°K придают обстановке комфорт и тепло.



AREA SUSPENSION

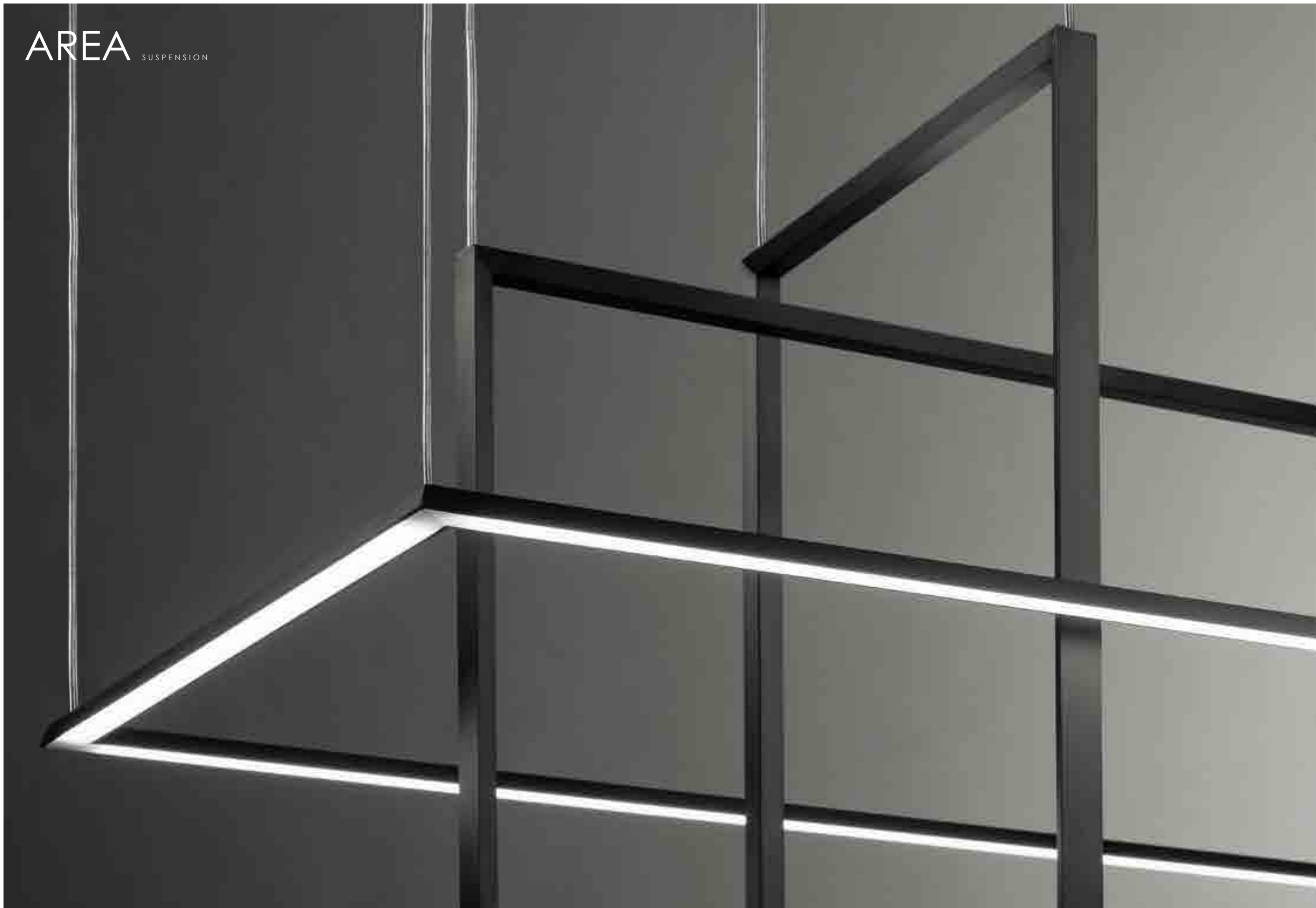

AREA



AREA SUSPENSION



AREA SUSPENSION



AREA CEILING

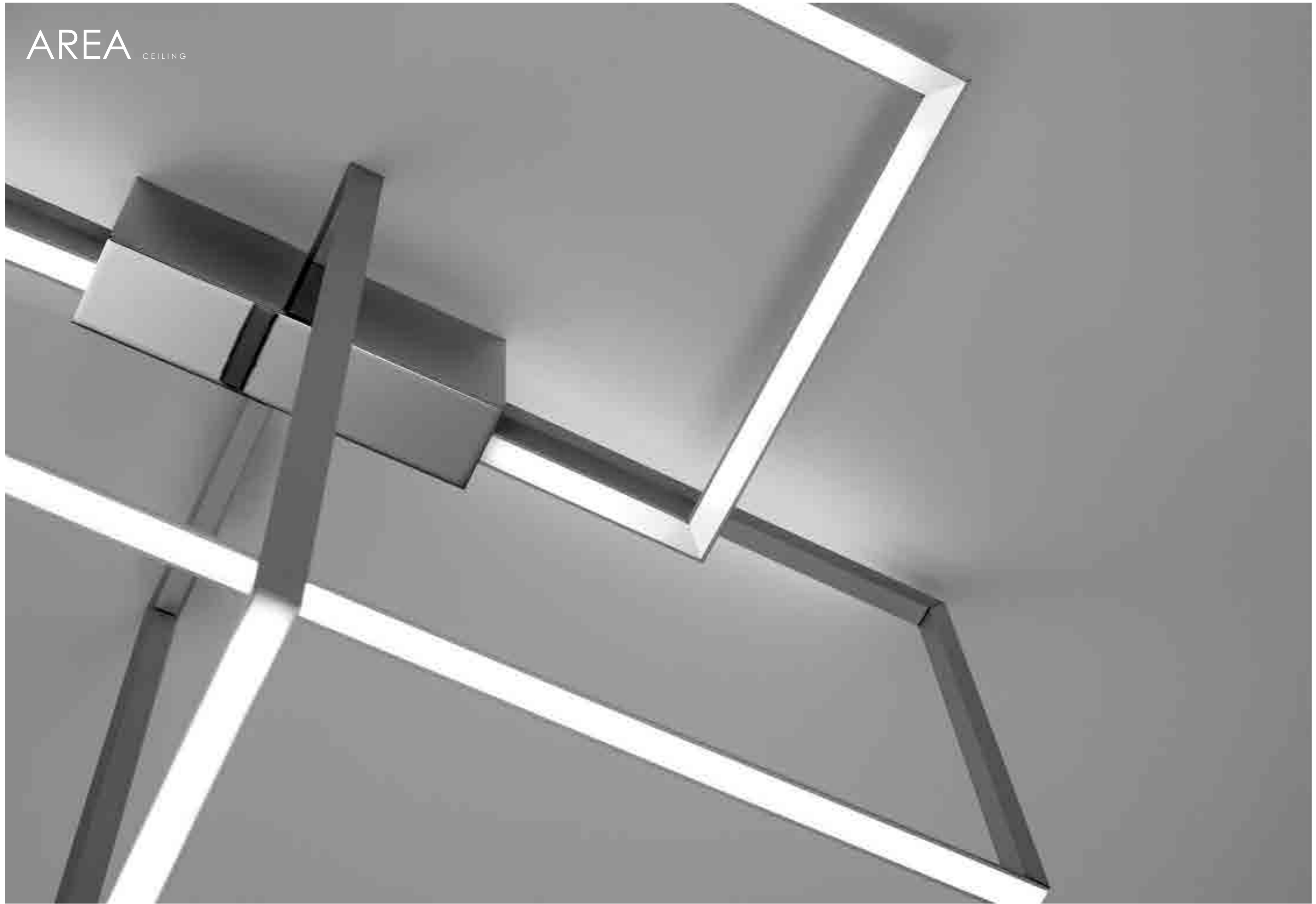

AREA CEILING

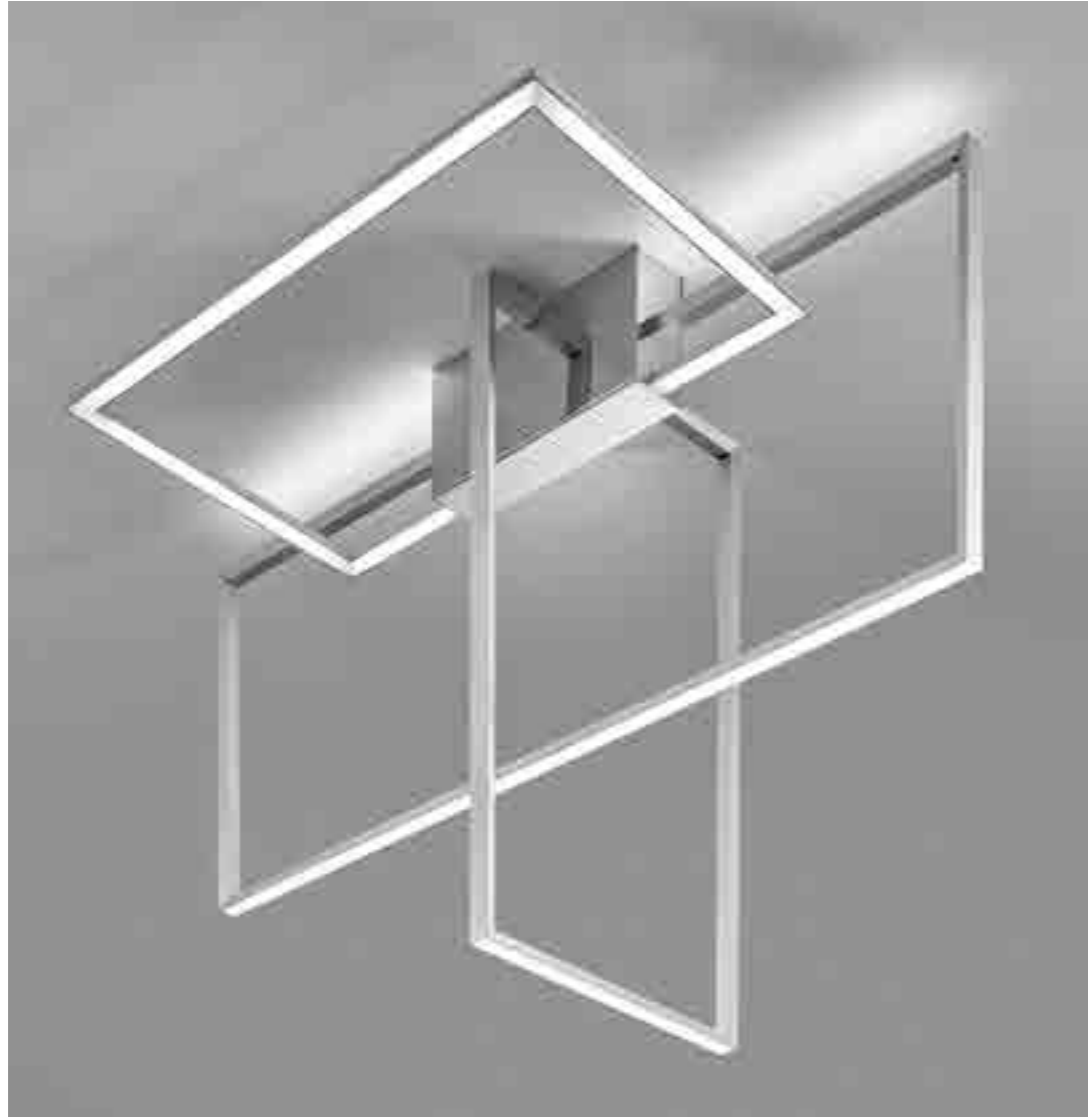

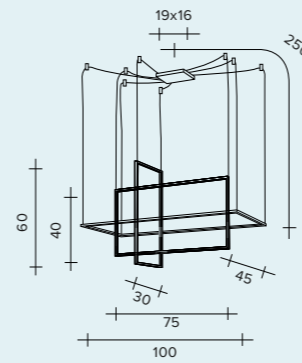

LED 60W - 12V
3000°K
450 ↑ Lumen
4050 ↓ Lumen

AREA Suspension

Lampada a sospensione
Pendelleuchte
Lámpara colgante
Подвесная лампа



FINISHES / FINITURE / FARBE / ACABADOS / ОТДЕЛКИ

- Aluminium / Alluminio / Aluminium
Aluminio / Алюминий
- Black / Nero / Schwarz
Negro / Чёрный цвет

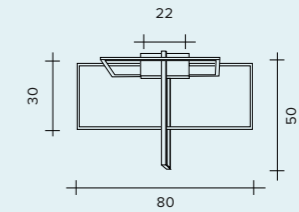

LED 42W - 12V
3000°K
315 ↑ Lumen
2835 ↓ Lumen

AREA Ceiling

Lampada da soffitto
Deckenleuchte
Lámpara de techo
Потолочная лампа



FINISHES / FINITURE / FARBE / ACABADOS / ОТДЕЛКИ

- Aluminium / Alluminio / Aluminium
Aluminio / Алюминий
- Black / Nero / Schwarz
Negro / Чёрный цвет

HONEY

BLACK EDITION

design Sforzin Illuminazione

HONEY BLACK EDITION

Three strong and decisive yet light and clear glass designs. Blown borosilicate glass, brushedchrome metal rose, power supply unit included. LED module: 5.3 W each, 424 lumen, 3000°K, 500 mA, non-dimmable.



HONEY BLACK EDITION

Tre disegni di vetro forti, decisi ma leggeri e trasparenti. Vetro soffiato borosilicato, rosone in metallo nero, alimentatore incluso. Modulo led 5,3 w cad, 424 lumen, 3000°k, 500 mA non dimmerabile.

HONEY BLACK EDITION

Drei starke und entschlossene, aber gleichzeitig auch leichte und transparente Glasdesigns. Geblasenes Borsilikatglas, Metallrosette in Schwarz, Netzteil eingeschlossen. LED-Modul jeweils 5,3 W, 424 Lumen, 3000°K, 500 mA nicht dimmerbar.

HONEY BLACK EDITION

Tres diseños de vidrio fuertes, resueltos y al mismo tiempo ligeros y transparentes. Vidrio de borosilicato soplado, embellecedor de metal negro, fuente de alimentación incluida. Módulo led 5,3 w cada uno, 424 lumen, 3000°k, 500 mA de intensidad luminosa no regulable.

HONEY BLACK EDITION

Три сильных, четких, но при этом легких и прозрачных дизайна стекла. Дутое боросиликатное стекло, потолочная чашка из черного металла, блок питания входит в комплектацию. Светодиодный модуль 5,3 Вт кажд., 424 люменов, 3000°K, 500 mA, не диммируемый.



HONEY BLACK EDITION

HONEY SUSPENSION
BLACK EDITION



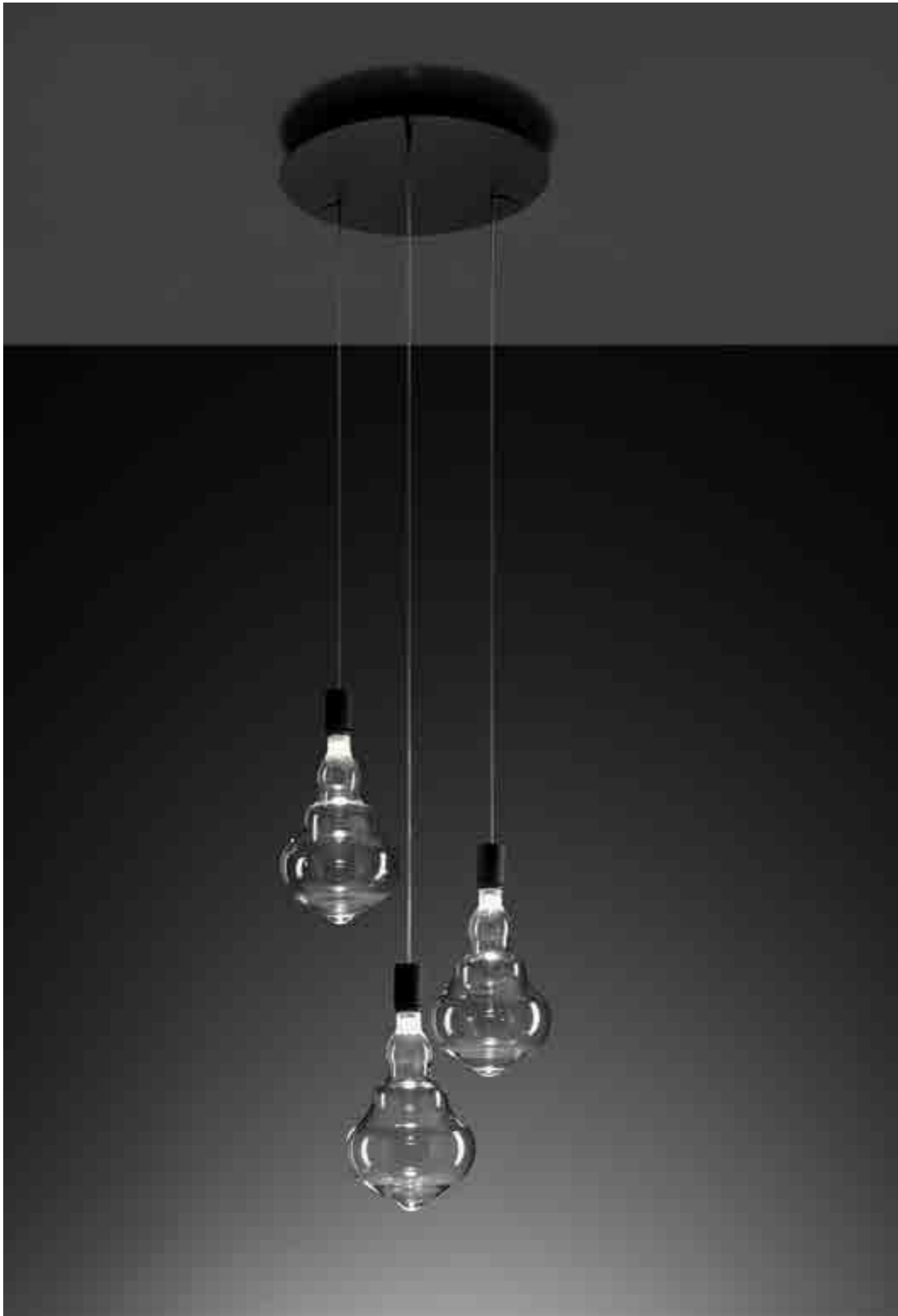

HONEY SUSPENSION
BLACK EDITION



HONEY SUSPENSION
BLACK EDITION





HONEY SUSPENSION
BLACK EDITION



HONEY SUSPENSION
BLACK EDITION





HONEY SUSPENSION
BLACK EDITION



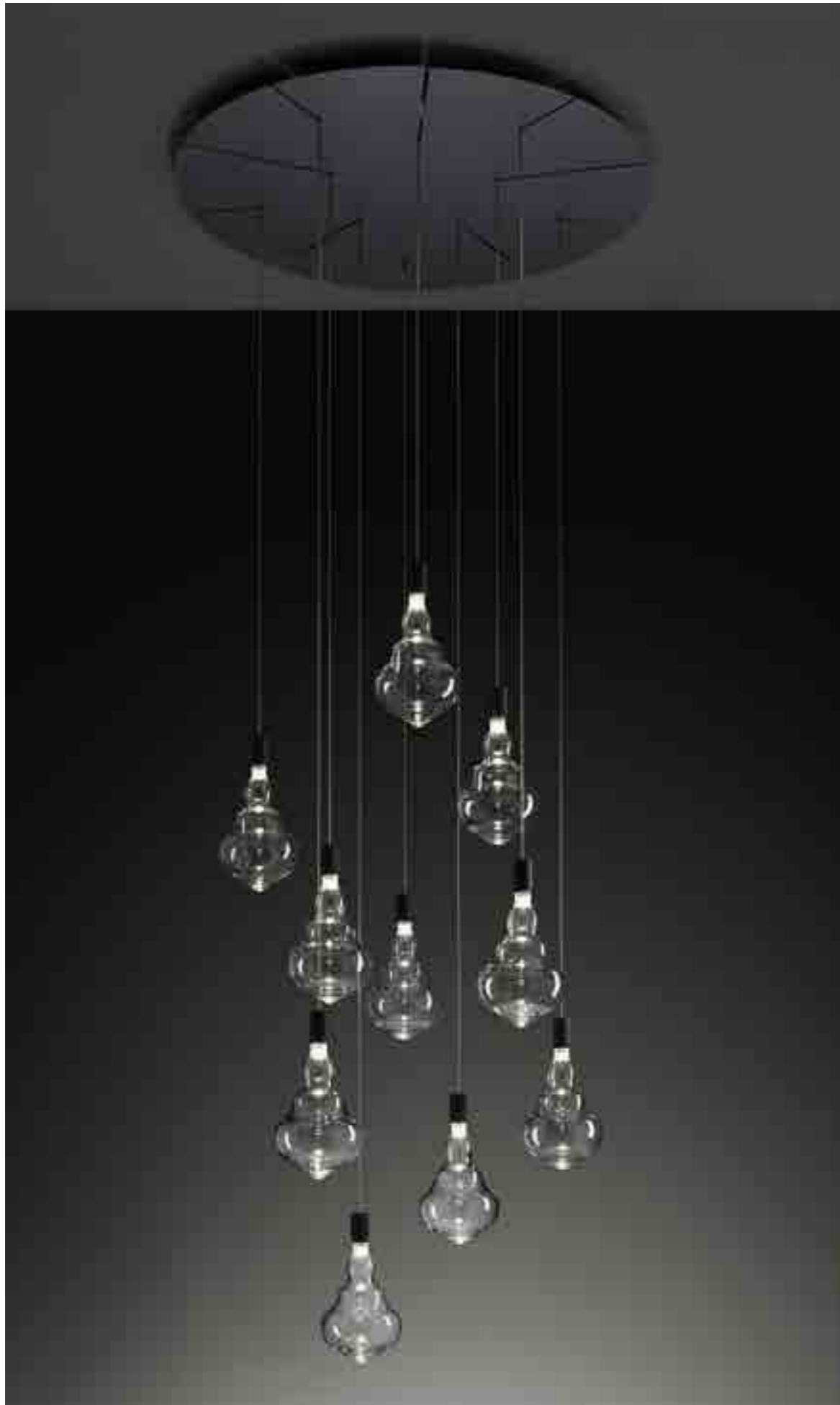

HONEY SUSPENSION
BLACK EDITION



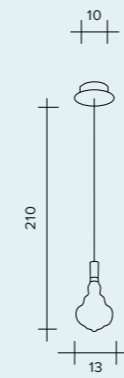

LED 5,3W - 500 mA
3000°K / 424 lumen

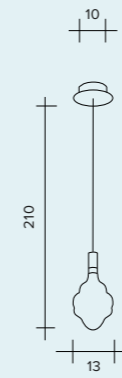

LED 5,3W - 500 mA
3000°K / 424 lumen

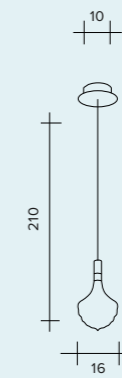

LED 5,3W - 500 mA
3000°K / 424 lumen

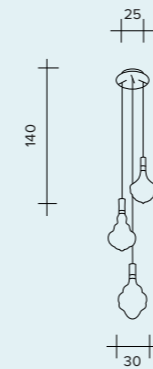

LED 15,9W - 500 mA
3000°K / 1272 lumen

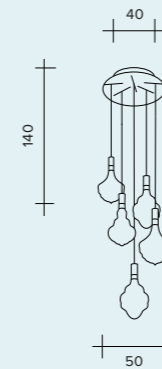

LED 31,8W - 500 mA
3000°K / 2544 lumen

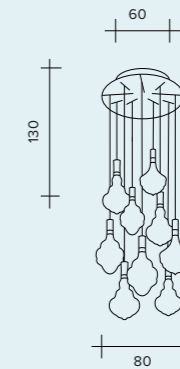

LED 47,7W - 500 mA
3000°K / 3816 lumen

HONEY BLACK EDITION Suspension

Lampada a sospensione
Pendelleuchte
Lámpara colgante
Подвесная лампа



FINISHES / FINITURE / FARBE / ACABADOS / ОТДЕЛКИ

GLASS
Vetri / Glas / Cristales / Стёкло

○ Trasparente / Transparent / Transparente / Прозрачный

BEBA

design Marco Sforzin

BEBA COLLECTION

Unique and decorative glass shades.
Blown borosilicate glass in four colours:
clear, chrome, bronze or gold.
Fixture with white decentralisation kit
or single drop roses with a white
painted finish. G9 connection.



BEBA COLLEZIONE

Vetri unici e decorativi.
Vetro borosilicato soffiato in quattro
colori: trasparente, croma, bronzo e oro.
Montatura con kit di decentramento
bianco o rosoni da una unica calata
verniciati bianco. Attacco G9

BEBA KOLLEKTION

Einzigartige und dekorative Gläser.
Geblasenes Borsilikatglas in drei Farben:
Transparent, Chrom, Bronze und Gold.
Gestell mit Versetzungs-Set in Weiß
oder Rosetten mit einfacher
Hängelänge in Weiß. Anschluss G9.

BEBA COLECCIÓN

Vidrios únicos y decorativos.
Vidrio de borosilicato soplado
en cuatro colores: transparente,
cromo, bronce y oro.
Montura con kit para descentrar
blanco o embellecedores con una
única bajada, pintados en color
blanco. Casquillo G9.

КОЛЛЕКЦИЯ ВЕВА

Уникальные декорированные
стекла. Дутое боросиликатное
стекло трех цветов: прозрачное,
хром, бронза и золото. Оправас
комплект для смещенного
крепления белого цвета или
с потолочными чашками,
покрытыми белой краской,
с одним выводом. Цоколь G9.

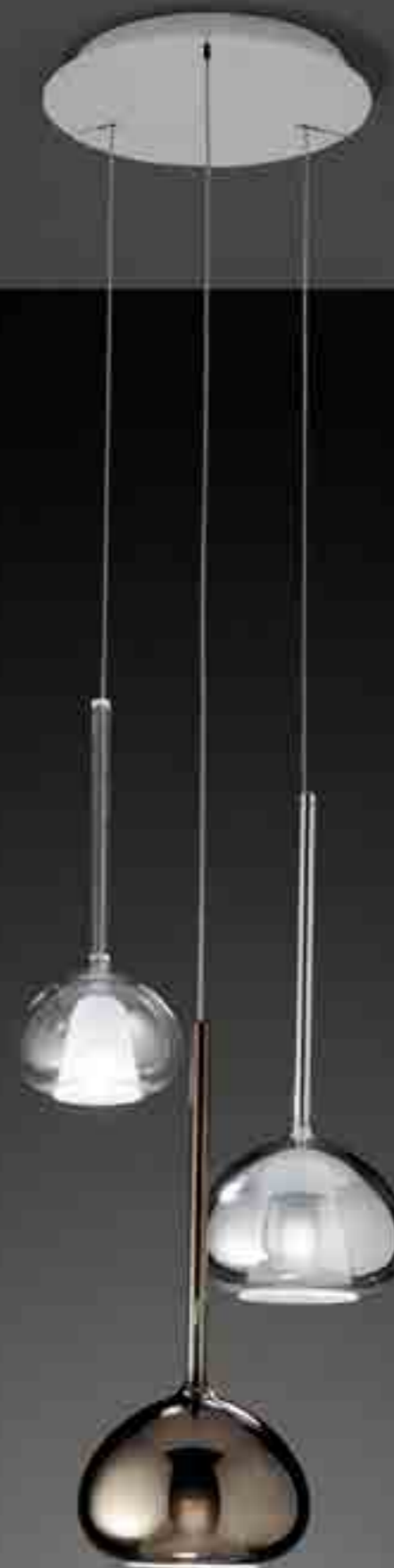

BEBA SUSPENSION



BEBA SUSPENSION





BEBA SUSPENSION





BEBA SUSPENSION



BEBA SUSPENSION



BEBA SUSPENSION





BEBA SUSPENSION



BEBA SUSPENSION



BEBA CANOPY

1730.M.30



G9 1x max 28W - 230V

1730.M.40

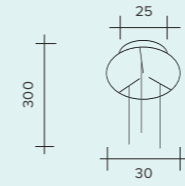

G9 3X max 28W - 230V

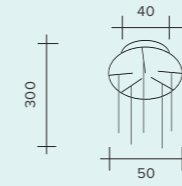

G9 5X max 28W - 230V

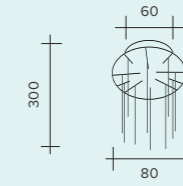

G9 10X max 28W - 230V

1730.M.34

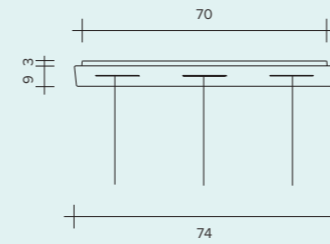

G9 3X max 28W - 230V

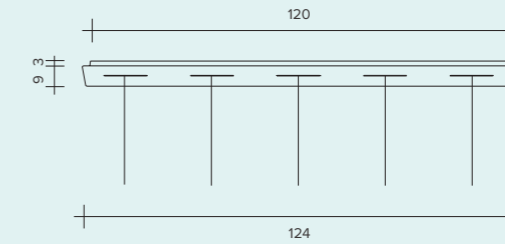

G9 5X max 28W - 230V

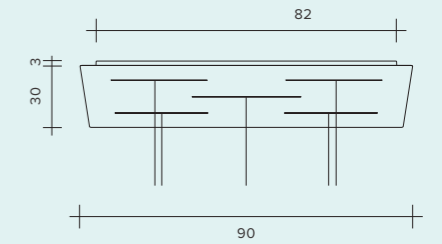

G9 5X max 28W - 230V

1730.M.41

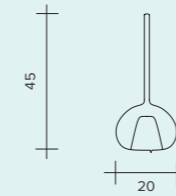
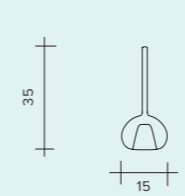

1730.M.35



BEBA Suspension

Lampada a sospensione
Pendelleuchte
Lámpara colgante
Подвесная лампа



FINISHES / FINITURE / FARBE / ACABADOS / ОТДЕЛКИ

GLASS Vetri / Glas / Cristales / Стёкло

- Trasparent / Trasparente / Transparent / Transparente / Прозрачный
- Chrome / Cromo / Chrom / Cromo / Хром
- Bronze / Bronzo / Bronze / Bronce / бронза
- Gold / Oro / Kupfe / Gold / Золото

CANOPY

Rosone / Baldachin / Florón / Основание светильника

- Embossed white / Bianco gofrato
Weiß gaufriert / Blanco gofrado / Белый гофрированный

1730.M.42



1730.M.36



See codes and prices from page to page / Vedi codici e prezzi da pag. a pag. / Artikelnummern und Preise siehe Seite bis Seite
Véanse códigos y precios desde pag. hasta pag. / См. коды и цены от страницы до страницы

308 - 309 - 310

OCTOBER 2021

THANKS TO:

CONCEPT & DEVELOPMENT: Red Apple International
AD: Marco Spatti
PHOTO: Paolo Volontè
FURNITURE: Bross Italia, Living Divani, Desalto, Moroso
CERAMICS: Paola Paronetto
RENDERING: Widestudio

Viale dell'Industria, 21
20037 Paderno Dugnano (MI) - Italy
Tel. +39 02 9104958 r.a. - +39 02 9105178
Fax +39 02 9185542
info@sforzinilluminazione.com
www.sforzinilluminazione.com

URBAN
L I G H T I N G